



Sial Surgical

is a leading supplier of custom designed
stainless steel surgical instruments with
worldwide shipping

Surgical
instruments catalogue

Company Profile

Introduction

The Sial Surgical Mfg. Industry with 5 Years of Experience. We are a team of expertise who committed to deliver the excellent quality of Instruments to make sure the perfection of professionals. We are proud to be a part of such sacred profession, saving lives by providing excellent quality of Instruments at very competitive price.

Company's Policy

The Sial Surgical do not compromise on quality of the products. We achieve quality excellence by using quality assurance programs and techniques. Prompt and dedicated services shall be ensured to customers and efficiently to the best of our ability.

Our Commitment

Our commitment to quality, based on our continuous monitoring at every stage of the manufacturing process has placed us at par with international standard, while maintaining very competitive prices. Quality Management System, The Sial Surgical manufacturing, process emphasizes quality above all else. The proper stainless steel, stamping and forged materials used are meticulously selected and go through highly effective quality control.

Our Staff

We are convinced that a highly qualified staff brings trust in our company. We are tight team, consisting of people, who with their education and experience contribute to our company strength.

Support

Our friendly and well-trained support staff is happy to assist you in any way even if you are looking for something not in our product range. We will do our best to help you.

Vision & Goals

To be the first choice through deliver high-quality, value-added, cost-effective services & services on schedule that exceed our client's expectation. This is achieved by allocating sufficient, resources, experts and dedicated teams, outstanding performance and professional integrity.

Sincerely

C.E.O

MISSION STATEMENT

“THE AVION VALUES THE TIME & QUALITY”

Organization Chart

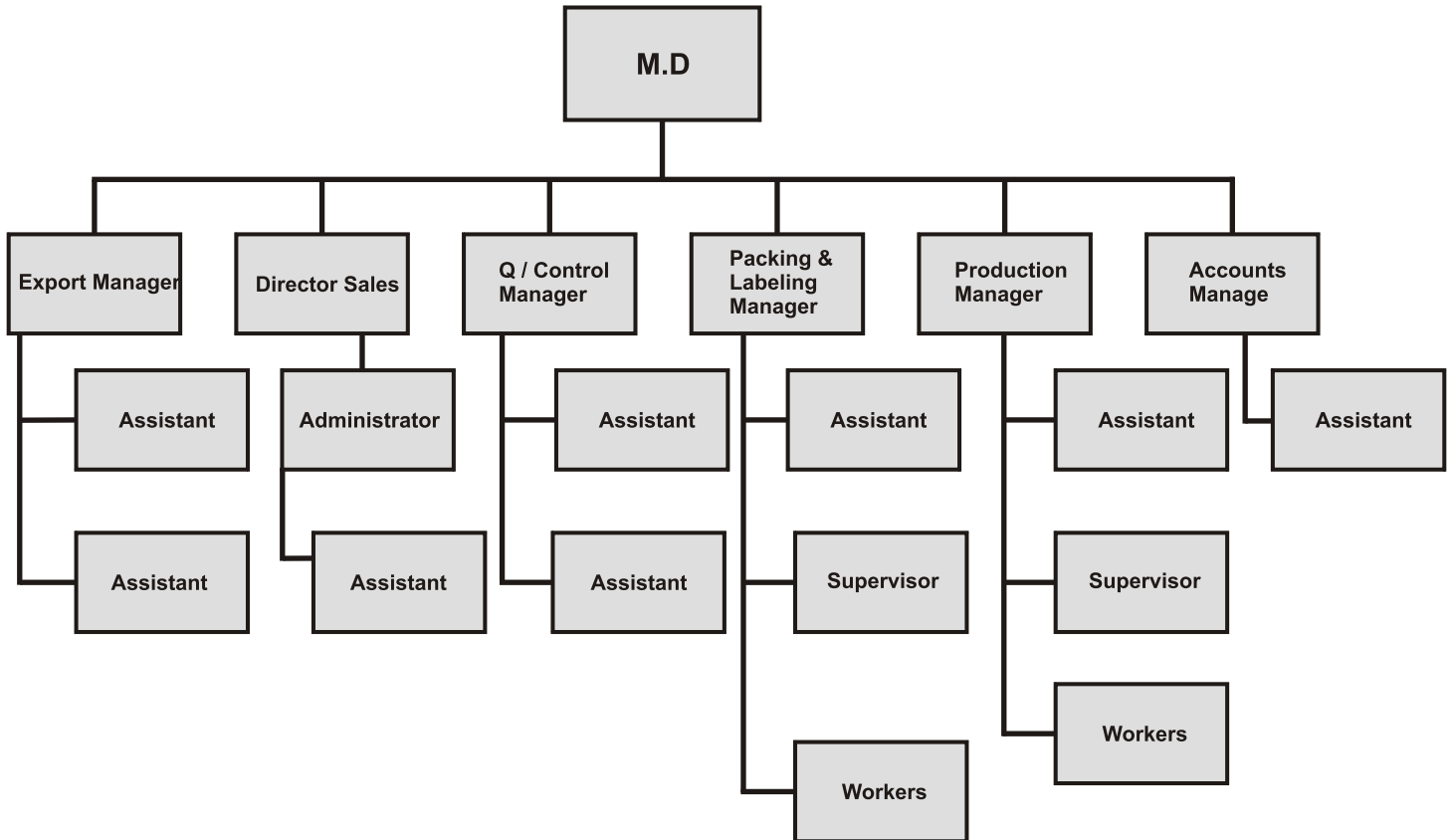



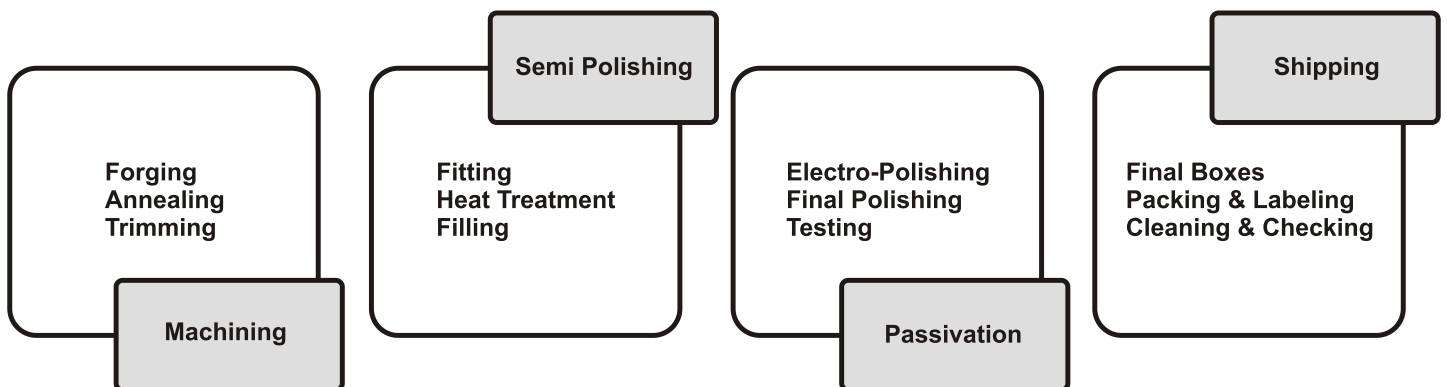

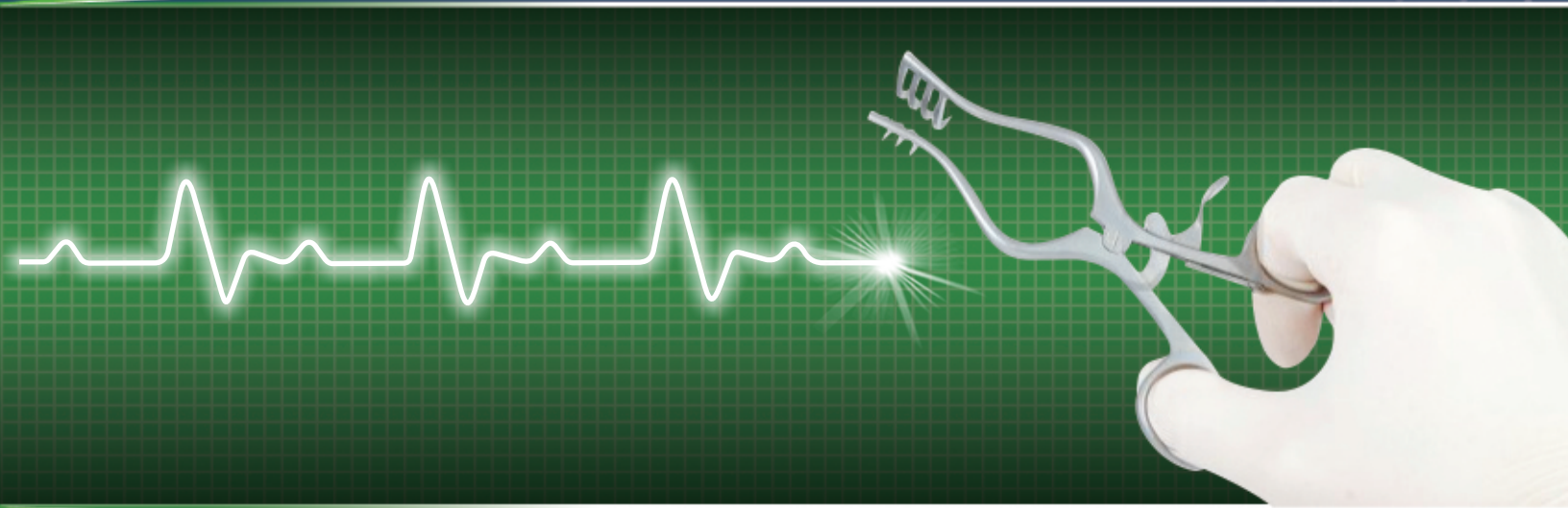

Process Flow Chart



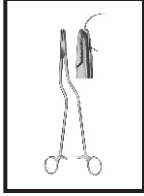

SUGICAL INSTRUMENTS CATALOGUE

01:	Diagnostic, Anaesthesia, Scalpels & Knives	01	1 - 22	
02:	Scissors	02	23 - 51	
03:	Forceps, Clamps	02	52 - 95	
04:	Needle Holders, Micro Needle Holders	02	96 - 101	
05:	Suture Instruments, Needles, Probes, Applicators, Pocket Instruments Set.	02	102 - 114	
06:	Hooks, Retractors, Spatulas, Spreaders, Abdominal Retractors	03	115 - 167	
07:	Forceps, Intestinal Clamps, Specula, Biopsy Forceps, Anusscopes	03	168 - 193	

08: Gall Duct Forceps / Probes / Scissors / Kidney Forceps, Urinary Instruments, Trocars **03** **194 - 208**

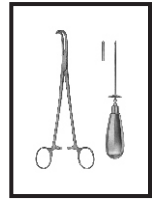

09: Vaginal Specula & Retractors **04** **209 - 220**



10: Utrine Dilators, Probes, Forceps, Myoma Instruments **04** **221 - 236**

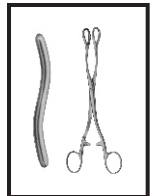

11: Biopsy Instruments, Utrine Curettes / Scoops **04** **237 - 245**

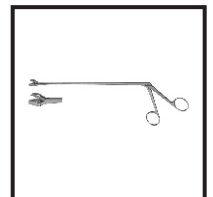

12: Obstetrics Instruments **04** **246 - 254**





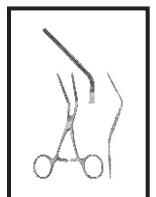



13: Tracheotomy, Cardiovascular & Thoracic Surgery **05** **255 - 309**



14: Bone Punches & Rongeurs **05** **310 - 318**

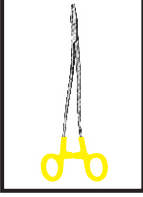

15:	Amputation, Elevators, Saws, Raspatories, Bone Livers, Bone Files & Curettes	06	319 - 347	
16:	Mallets, Tampers, Chisels, Gauges, Bone Holding Forceps, Bone Rongeurs, Bone Cutting Forceps, Meniscus Instruments	06	348 - 379	
17:	Wire Extension, Finger Nail Instruments	06	380 - 392	
18:	Plaster Instruments	07	393 - 397	
19:	Suction Instruments	07	398 - 404	
20:	TUNGSTEN CARBIDE INSERTS	07	405 - 421	
21:	HOSPITAL WARES	07	422 - 432	

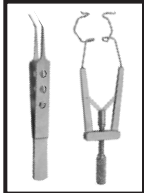
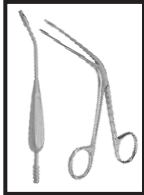
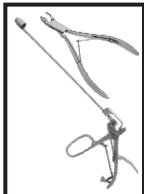
DESCRIPTION	SECTION	PAGE #	
Ophthalmology			
22: • Speculums • LASIK Spatulas, Choppers, Nucleus Manipulators • IOL Manipulators, Spatulas, Loops, Lens Loops • Fixation Hooks, Muscle Hooks, Lasik Markers • Calipers, Scissors • Forceps, Titanium Forceps • Needle Holders, Rongeurs, Lacrimal Instruments • Sterilizing Cases & Trays, D90 Micro cassttes & Tonometer	08	433 - 455	
<hr/>			
23: Ent Instruments • Oral Maxillo-Facial Surgery • Cranic Maxillo-Facial Surgery • Tonsilectomy Laryngo-Bronchoscopy • Otology • Rhinology	09	456 - 495	
<hr/>			
24: Vasectomy and Beauty Care Instruments • Vasectomy Instruments • Hemorrhoid Ligator Instruments • Bone Drills • Beauty Care Instruments	10	496 - 501	

Percussion Hammers & Aesthesiometers



ITB-01-2001
TROEMNER
Size: 245 mm

1/2



1/2

ITB-01-2002
DEJERINE
Size: 200 mm



1/2

ITB-01-2003
DEJERINE
With Needle
Size: 210 mm



1/2

ITB-01-2004
TAYLOR
Size: 195 mm



1/2

ITB-01-2005
BERLINER
Size: 200 mm



1/2

ITB-01-2006
BUCK
With Needle
And Brush
Size: 180 mm



1/2

ITB-01-2007
RABINER
With Needle
And Brush
Size: 255 mm



1/2

ITB-01-2008
ALY
Size: 190 mm



1/2

ITB-01-2009
WARTENBERG
Pinwheel For
Neurological
Examination
Size: 185 mm

Stethoscopes Stethoskope



01-2010
PINARD
of aluminium
Size: 155 mm

1/2



01-2011
aus Holz
Wooden
Size: 145 mm

1/2



01-2012
BOWLES
Stethoscope With
Diaphragm,
In Plastic Pouch

1/4



01-2013
ANESTOPHON
Ø47mm

1/3



01-2014
FORD-BOWLES
Combination Stethoscope
With Diaphragm and Bell
Dual Chest Piece
With Two Outlets

1/4



01-2015
BOWLES
Stethoscope With
Diaphragm,
Flat Model,
Suitable Also
For Anaesthesia
Chest Piece Only
40 mm Diam

1/4



Head Mirrors & Head Bands



01-2016
ZIEGLER Ø 90mm
Head mirror only
with rubber coating



01-2017
ZIEGLER Ø 90mm
Head mirror only
with metal coating



01-2018
ZIEGLER
Head band of plastic, black only

01-2019
ZIEGLER
Head band of plastic, white only



01-2020
MURPHY
Head band of celluloid, white only



01-2021
Head band of plastic,
white, soft pattern



01-2022
Head mirror
with black plastic head
band

Head Lights



01-2026
spare bulb

01-2023
CLAR
Head light, 6 volt, with adjustable joint, white celluloid head band, cord with plugs for transformer

01-2024
White celluloid head band, only, for **01-2023**

01-2025
Spare mirror only, for **01-2023**

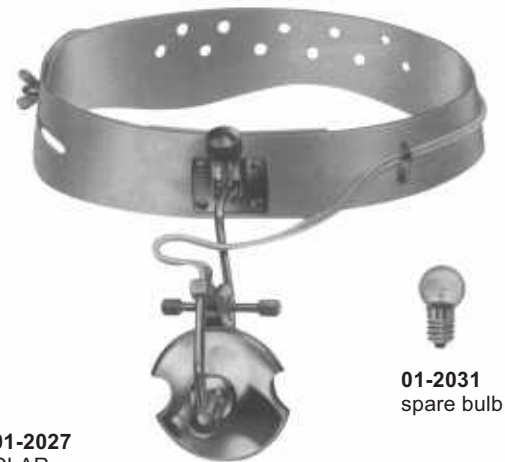

01-2027
CLAR
Head light, 6 volt, with adjustable joint, white celluloid head band, with foam rubber pad and cord with plugs for transformer

01-2028
White celluloid head band, only, for head light

01-2029
mirror only, for head light

01-2030
spare foam rubber pad, for head band



01-2033
spare bulb

01-2032
JANSEN
Head light, 6 volt, with adjustable joint, white plastic head band, cord with plugs for transformer



01-2035
spare bulb

01-2034
LANGENBECK
Head light, 3.7 volt, with adjustable joint, white plastic head band, cord with plugs for transformer



01-2036
HERBERHOLD
Pocket-Accu, 6 volts, with cord for head lights



01-2037
Extension cord only, to connect the accu to the cord of the head lights



01-2038
Charging Set for pocket accu **01-2036**
mains current: 220-240 volts, 50-60 Hz



01-2039
220 volt / 220 volts
01-2040
120 volt / 120 volts
Transformer

Tongue Depressors, Retractors

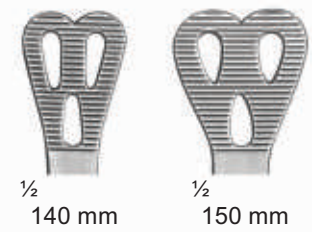
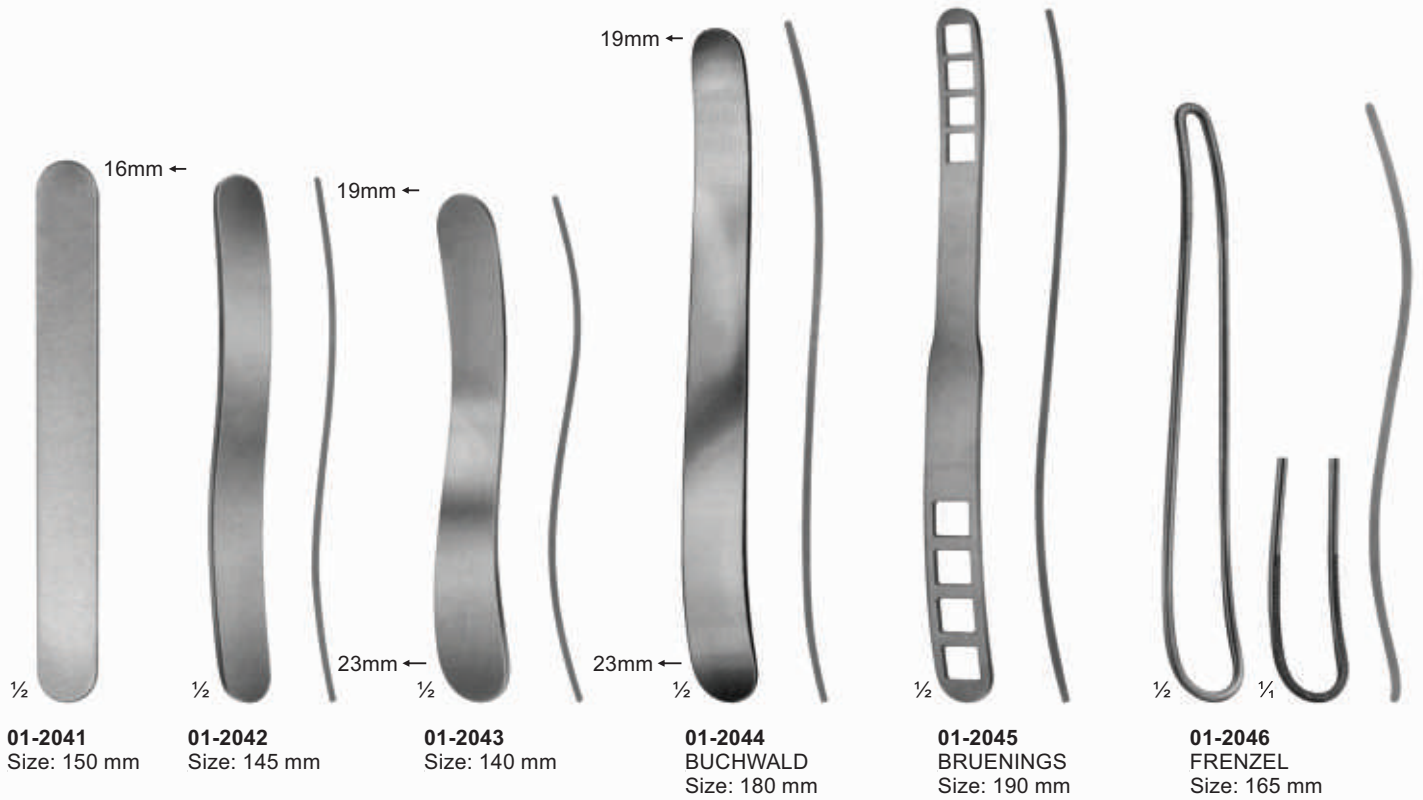

Mouth Gags And Tongue Forceps



1/2
01-2055
SCHIMMELBUSCH
Ether Mask



1/2
01-2056
HEISTER
Mouth Gag
Size: 130 mm



1/2
01-2057
FERGUSSON-ACKLAND
Mouth Gag
Size: 145 mm



1/2
01-2058
DENHARDT
Mouth Gag With
Silicon Inserts,
Interchangeable
Size: 125 mm



1/2
01-2059-01-2060
ROSER KOENIG
Mouth Gag
Size: **01-2059** 160mm
01-2060 185mm



1/2
01-2061
YOUNG
Size: 165 mm



1/4
01-2062
1 Pair Of
Rubber Pads



1/2
01-2063-2064
COLLIN



1/4
01-2063
Size: 160 mm



1/4
01-2064
Size: 170 mm

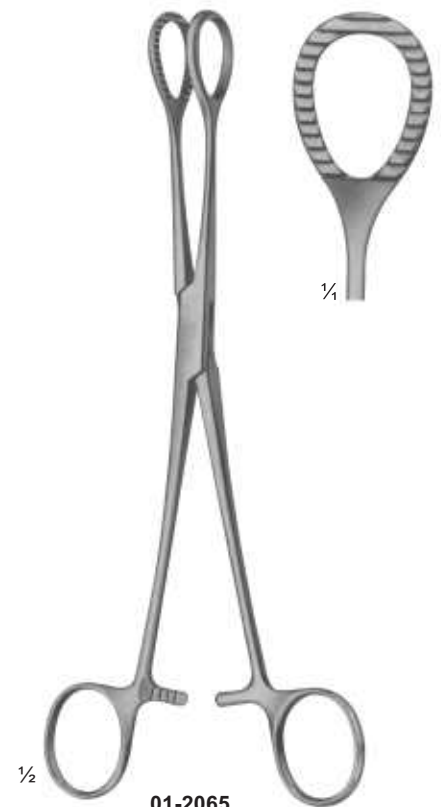

1/2
01-2065
HEYWOOD-SMITH modif.
Size: 215 mm

Blood Lancets & Laryngeal Mirrors



1/2
01-2066
MICHEL
Rhinoscopic Mirrors
With Interchangeable
Mirror Inserts
Size: 250 mm



1/4
01-2067
Ø 12 mm
Spare Mirrors Only



1/4
01-2068
Ø 14 mm
Spare Mirrors Only



1/2
01-2069
Mirror Handle
Size: 110 mm



1/2
01-2070
Mirror Handle
Size: 105 mm



1/2
01-2071
FRANCKE
Automatic
Blood Lancet



01-2072
KOLLE
Microscopic
Needle Holder
With Plastic
Handle
Size: 240 mm



1/2
01-2073
Laryngeal Mirrors With
Hexagonal Handle
Size: 180 mm



Fig. 000
Ø 6mm



Fig. 00
Ø 8mm



Fig. 0
Ø 10mm



Fig. 1
Ø 12mm

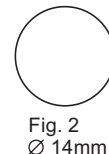

Fig. 2
Ø 14mm

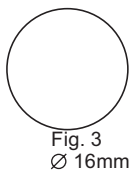

Fig. 3
Ø 16mm

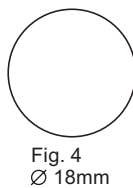

Fig. 4
Ø 18mm

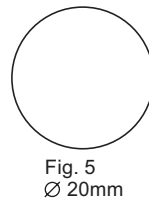

Fig. 5
Ø 20mm

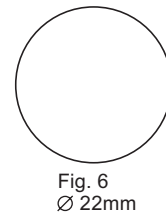

Fig. 6
Ø 22mm

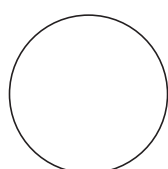

Fig. 7
Ø 24mm

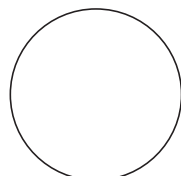

Fig. 8
Ø 26mm

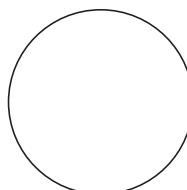

Fig. 9
Ø 28mm

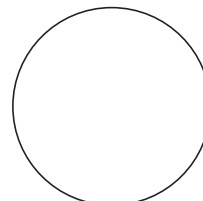

Fig. 10
Ø 30mm

Diagnostic Sets



1/2

01-2074 - 01-2076
MAGILL
Catheter Introducing
Forceps



1/4

01-2074
Infants
Size: 150 mm



1/4

01-2075
Children
Size: 200 mm



1/4

01-2076
Adults
Size: 250 mm



1/2

01-2077
Medium battery handle
only, 25 mm diam.



01-2078
Spare bulb
2.7 volt, for
Otoscopes etc.



01-2079
Spare bulb
2.6 volt, for
ophthalmoscopes



01-2080
Otoscope Set, Consists Of
Battery Handle Without Batteries,
3 Ear Specula, 1 Bulb In Velvet Lined Case



01-2081
Diagnostic Set, Otoscope With Three Specula,
Nasal Speculum, Lamp Holder, Two Laryngeal
Mirrors, Tongue Blade Holder

Laryngoscopes



1/3

01-2082
MILLER
Laryngoscope Set, Consists Of Battery Handle (Without Battery)
With Five Miller Laryngoscope Blades, Fig 1 to 5

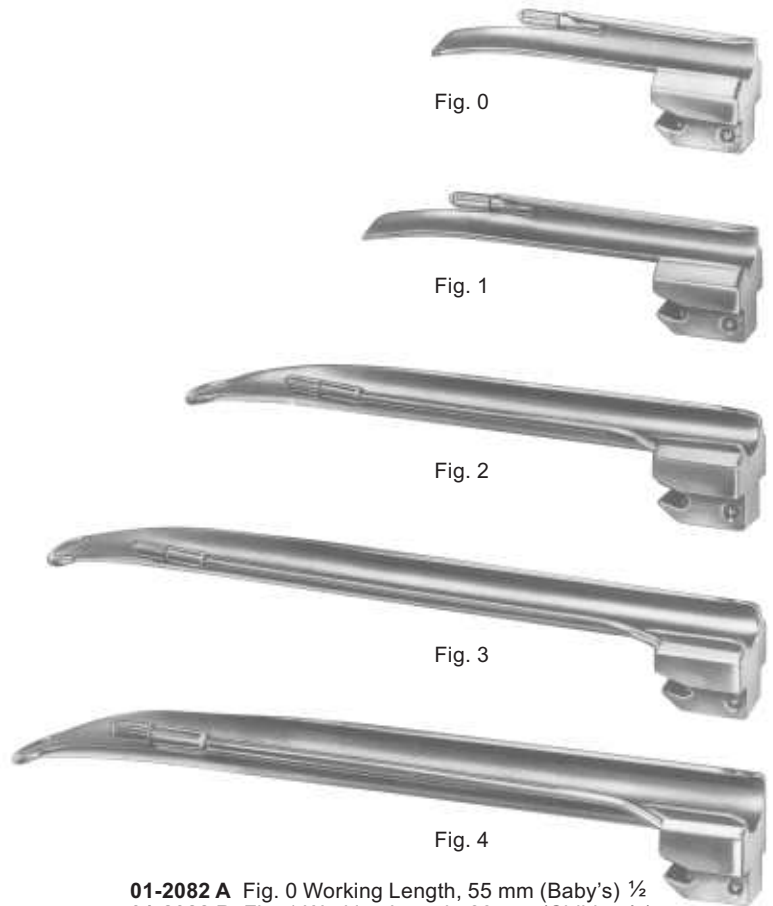

01-2082 A Fig. 0 Working Length, 55 mm (Baby's) 1/2
01-2082 B Fig. 1 Working Length, 80 mm (Children's)
01-2082 C Fig. 2 Working Length, 130 mm (Adolescent's)
01-2082 D Fig. 3 Working Length, 170 mm (Women's)
01-2082 E Fig. 4 Working Length, 180 mm (Men's)



1/3

01-2083
GUEDEL-NEGUS
Laryngoscope Set, Consists Of Battery Handle (Without Battery)
With Four Miller Laryngoscope Blades

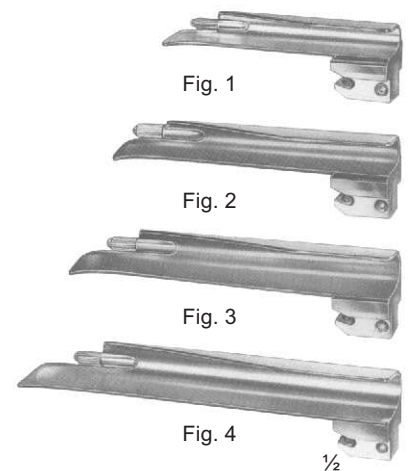

01-2083 A Fig. 1 Working Length, 70 mm (Children's)
01-2083 B Fig. 2 Working Length, 90 mm (Adolescent's)
01-2083 C Fig. 3 Working Length, 110 mm (Women's)
01-2083 D Fig. 4 Working Length, 135 mm (Men's)

Laryngoscopes



01-2084
McINTOSH
Laryngoscope Set, Consists Of Battery Handle (Without Battery)
With Three McIntosh Blades, Fig. 1, Fig. 2, Fig. 3



Fig. 0



Fig. 1



Fig. 2



Fig. 3



Fig. 4

1/2

01-2085
McINTOSH
Laryngoscope Set, Consists Of Battery Handle (Without Battery)
With Five McIntosh Blades, Fig. 0, Fig. 1, Fig. 2, Fig. 3, Fig. 4

01-2085 A Fig. 0 Working Length, 55 mm (Baby's)
01-2085 B Fig. 1 Working Length, 75 mm (Children's)
01-2085 C Fig. 2 Working Length, 90 mm (Adolescent's)
01-2085 D Fig. 3 Working Length, 110 mm (Women's)
01-2085 E Fig. 4 Working Length, 135 mm (Men's)

01-2086
FOREGGER
Laryngoscope Set, Consists Of
Battery Handle (Without Battery)
With Three Foregger Blades,
Fig. 1, Fig. 2, Fig. 3,



Fig. 1



Fig. 2



Fig. 3



Fig. 4

1/2

01-2087
FOREGGER
Laryngoscope Set, Consists Of
Battery Handle (Without Battery)
With Four Foregger Blades,
Fig. 1, Fig. 2, Fig. 3, Fig. 4,

01-2086 A Fig. 1 Working Length, 70 mm (Children's)
01-2086 B Fig. 2 Working Length, 90 mm (Adolescent's)
01-2086 C Fig. 3 Working Length, 110 mm (Women's)
01-2086 D Fig. 4 Working Length, 135 mm (Men's)



1/2

01-2088
Fiber Optic
Battery Handle
30mm diam.



1/2

01-2089
Fiber Optic
Battery Handle
18mm diam.



1/4

01-2090
Replacement Lamp
(Krypton) 2.5 V



1/4

01-2091
Replacement Lamp
(Halogen) 2.5 V

Examination & Measuring Instruments

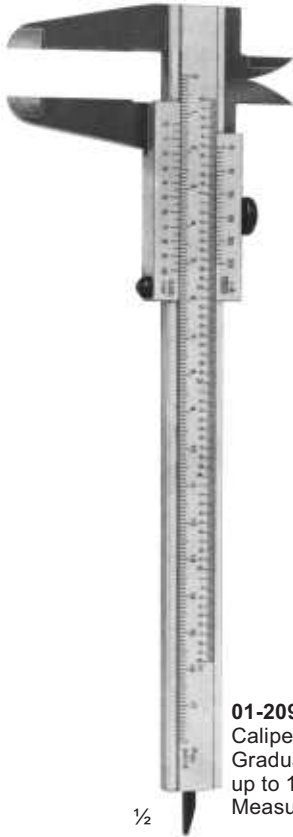

01-2092
Caliper Of Aluminium
Graduated in mm & inches
up to 180mm
Measuring Range up to 139mm

1/2



01-2093
VERNIER
Universal Caliper Of Steel
Graduated in mm & inches
up to 180mm
Measuring Range up to 120mm
with Vernier in 1/10mm & 1/16"

1/2



1/2

01-2094
CARROLL
Size: 145 mm
Finger Goniometer



1/2

01-2095
TOWNLEY
Graduated in
mm & inches
Size: 115 mm



1/2

01-2096
COLLIN
Druck Pressure 72 kg
Size: 125 mm



1/2

01-2097
BERTILLON
Caliper For Measuring The Head
Size: 320 mm



1/4

01-2098
CASTROVIEJO
Caliper
Size: 75mm



1/2

01-2099
MOLTGEN
Goniometer



01-2100A
Size: 150 mm



01-2100
Size: 500 mm



Dissecting Knives



01-2101 - 01-2110
Fig. 1 - 10
With Metal Handle



01-2101
Fig. 1
Size: 30mm
15cm



01-2102
Fig. 2
Size: 36mm
15cm



01-2103
Fig. 3
Size: 40mm
15.5cm

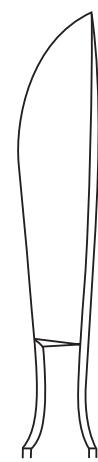

01-2104
Fig. 4
Size: 45mm
16cm



01-2105
Fig. 5
Size: 50mm
16cm



01-2106
Fig. 6
Size: 27mm
15cm



01-2107
Fig. 7
Size: 35mm
15cm



01-2108
Fig. 8
Size: 40mm
16cm



01-2109
Fig. 9
Size: 47mm
16cm



01-2110
Fig. 10
Size: 50mm
17cm

Autopsy & Cartilage Knives

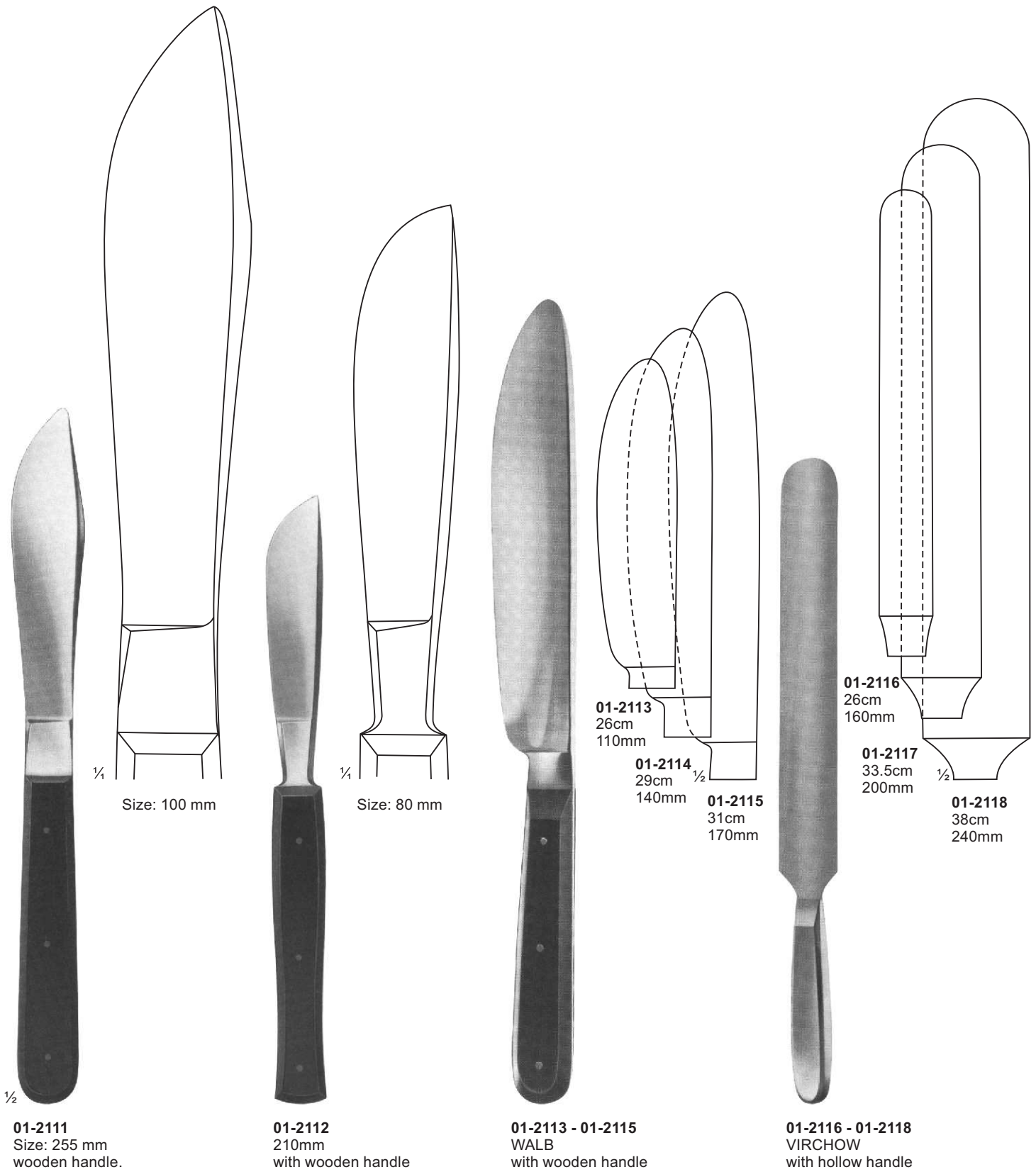

Scalpels, Tenotomes & Resection Knives

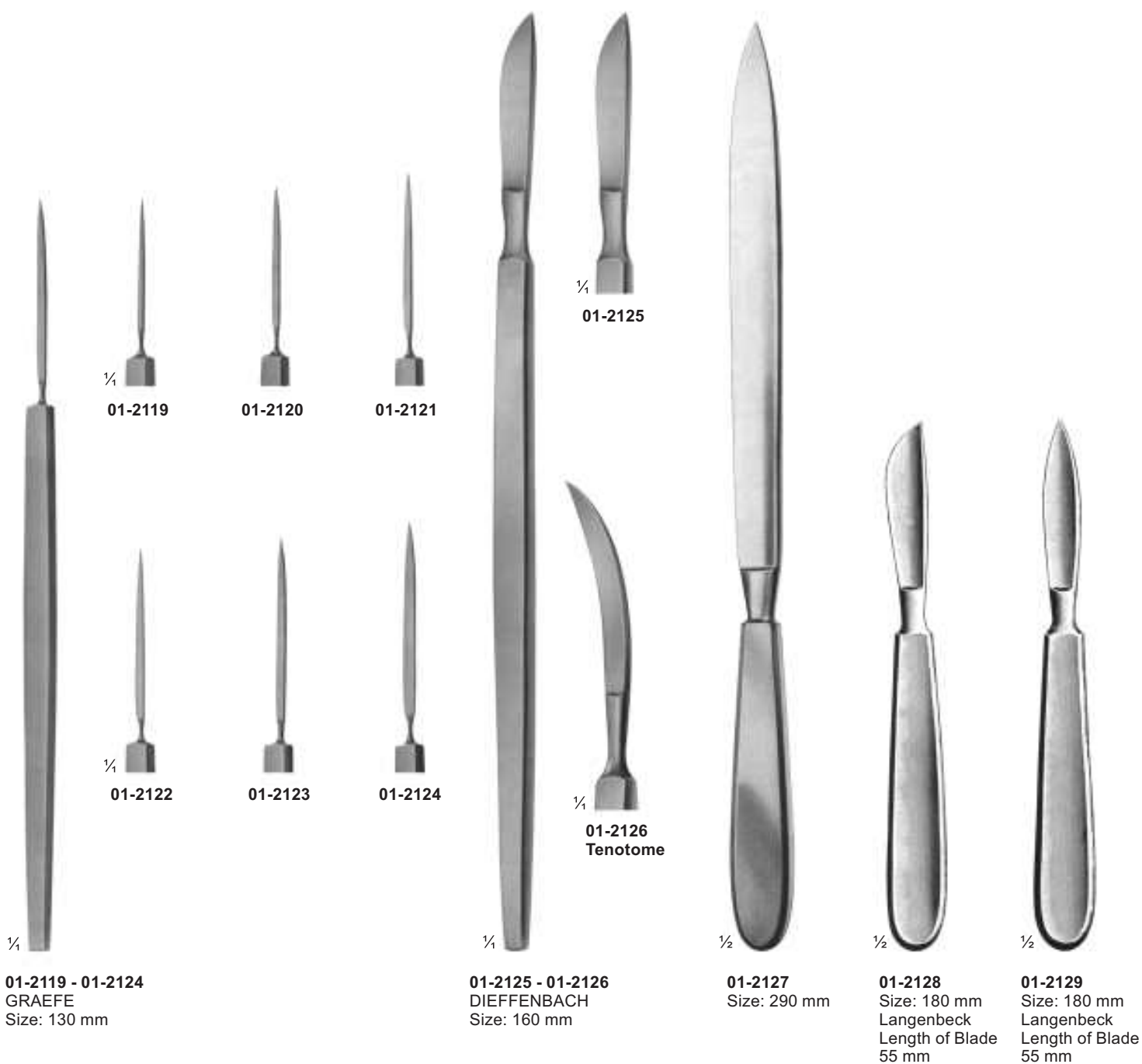

Amputating Knives, Cartilage Knives, Autopsy Knives

Double Cutting

Double Cutting



LISTON
01-2150
Size: 130 mm
01-2151
Size: 160 mm
01-2152
Size: 190 mm
01-2153
Size: 220 mm

01-2154
CATLIN
Size: 160 mm
Blade Length
Amputating
Knives

01-2155
LANGENBECK
Size: 120 mm
Blade Length
Flap Knives

01-2156
Size: 110 mm
Blade Length
Interosseous
Knives

01-2157
Size: 55 mm
Blade Length
With Raspatory,
Wooden Handle

01-2158
Size: 70 mm
Blade Length
Wooden Handle

01-2159
Size: 80 mm
Blade Length
Metal Handle

01-2160
Size: 195 mm
Blade Length
Metal Handle

Blade Length
Amputating Knives

Cone Knives, Myomatome, Trigeminal & Tonsil Knives



2/3

01-2161
AYRE
Size: 235 mm
Cone Knife

2/3

01-2162
Size: 230 mm
Cone Knife

2/3

01-2163
SEGOND
Size: 270 mm
Myomatome

1/4

01-2164
OLIVECRONA
Size: 205 mm
Trigeminal
Knife

1/4

01-2165
Size: 230 mm
Trigeminal
Knife

1/4

01-2166
FOWLER
Size: 200 mm
Tonsil Knife

1/4

01-2167
ABRAHAM
Size: 215 mm
Tonsil Knife

1/4

01-2168
BRUENINGS
Size: 215 mm
Tonsil Knife

Scalpels, Dura Knives & Comedone Extractors

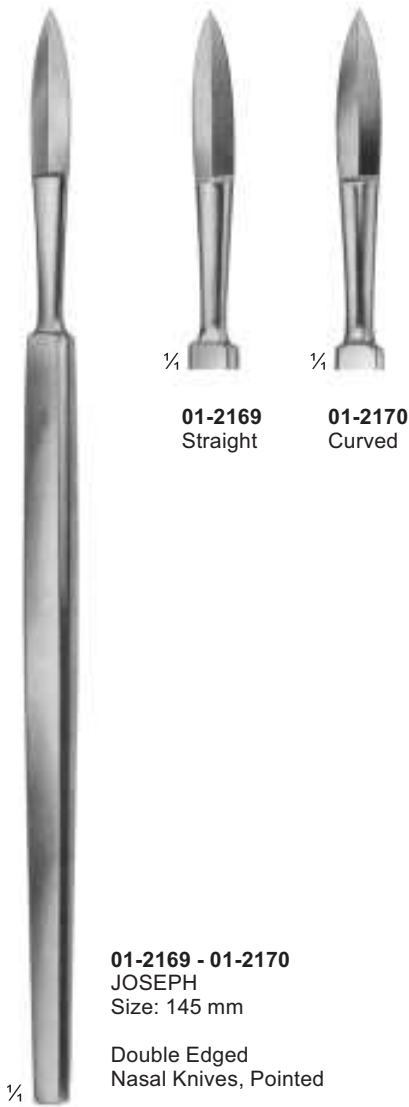

01-2169
Straight

01-2170
Curved

01-2169 - 01-2170
JOSEPH
Size: 145 mm

Double Edged
Nasal Knives, Pointed

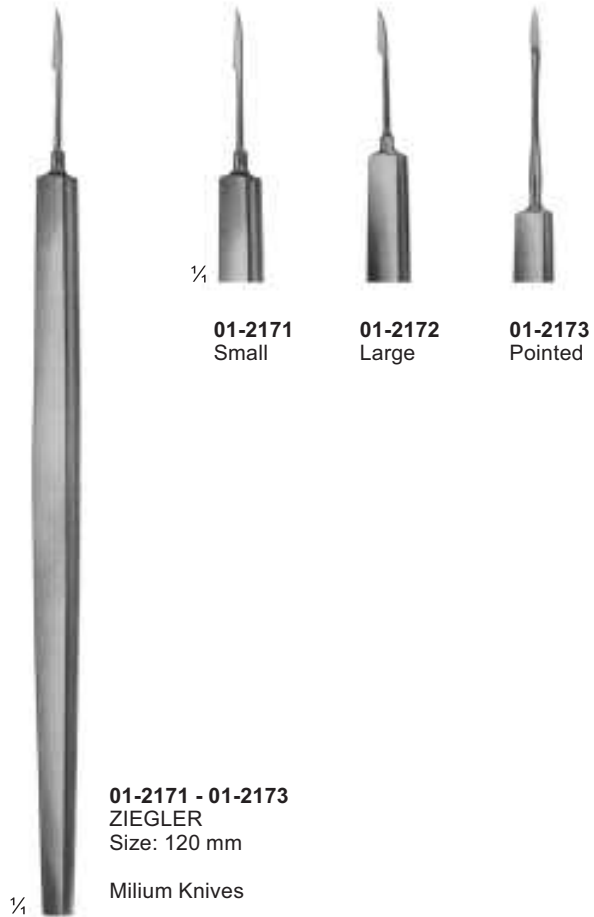

01-2171
Small

01-2172
Large

01-2173
Pointed

01-2171 - 01-2173
ZIEGLER
Size: 120 mm
Milium Knives



01-2174
VIDAL
Lupus Scraper
Size: 135 mm



01-2175
MONCORPS
Milium Knives
Size: 130 mm



01-2176
SAALFELD
Size: 100 mm

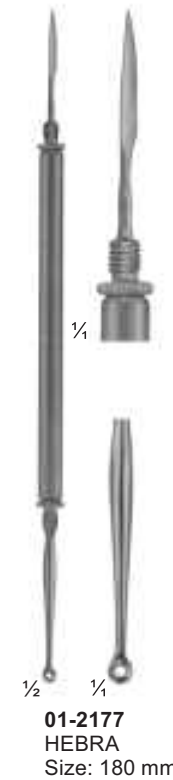

01-2177
HEBRA
Size: 180 mm



01-2178
Size: 145 mm



01-2179
UNNA
Size: 145 mm

Razor Blade Holders & Breakers



01-2180
TROUTMAN-CHRIS
Size: 90 mm
Handle Diameter 5.5 mm



01-2181
TROUTMAN-CHRIS
Size: 90 mm
Handle Diameter 5.5 mm



01-2182
Size: 110 mm



01-2183
CASTROVIEJO
Size: 130 mm
Handle Diameter 8 mm



01-2184
Size: 185 mm
Razor Blade
Breaker & Holder,
Straight

Scalpel Handles



¼
01-2185
 STANDARD
 No. 4
 Solid

¼
01-2186
 Double Handle
 No. 4 + No. 3
 Solid

¼
01-2187
 No. 4 L
 Straight
 Solid

¼
01-2188
 No. 4 L
 Solid Angled

¼
01-2189
 COLLIN
 No. 8
 Hollow

¼
01-2190
 COLLIN
 No. 9
 Hollow

¼
01-2191
 Plastic
 No.4

Scalpel Handles

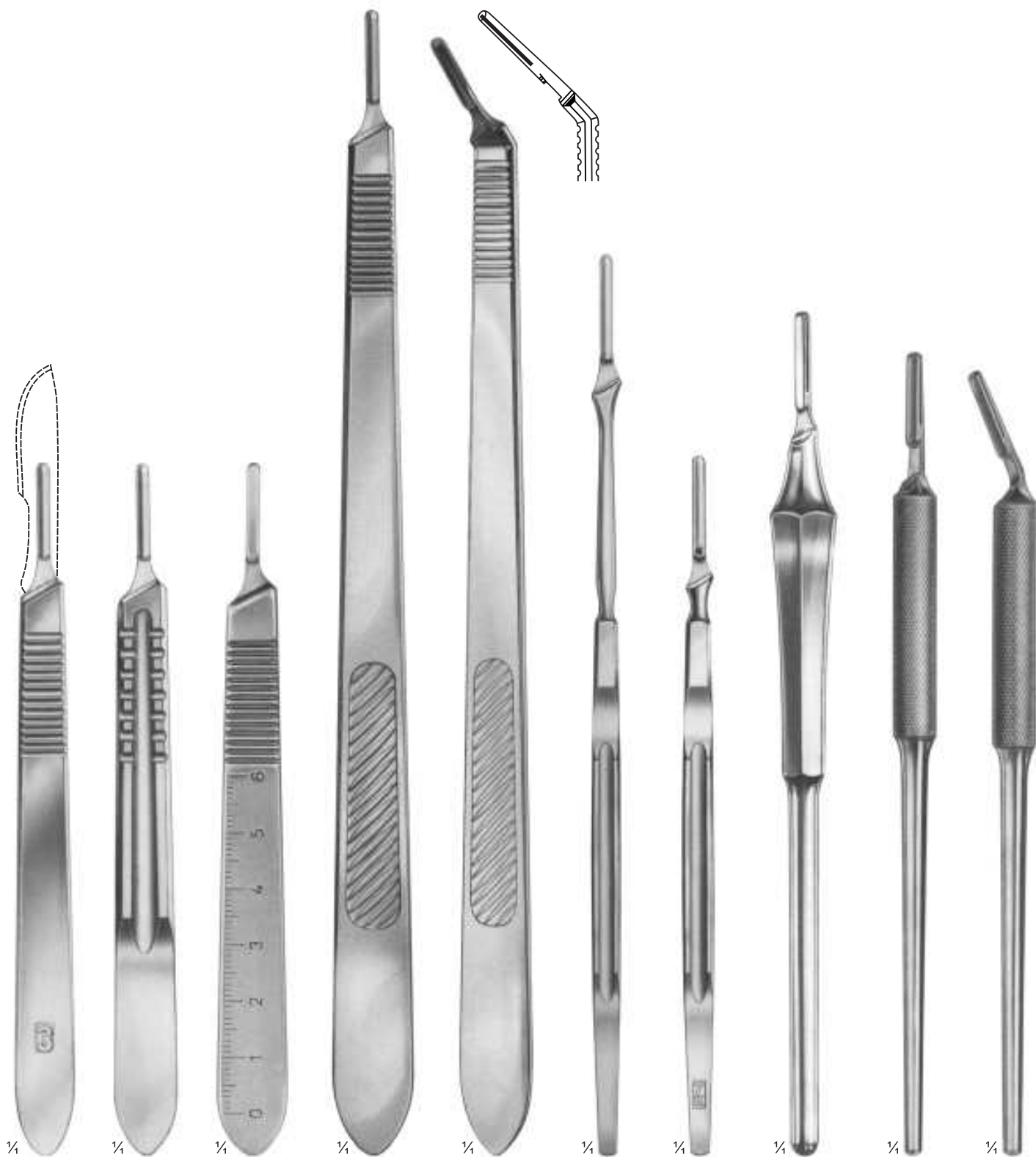

01-2192
STANDARD
No. 3
Solid
Size:12cm

01-2193
No. 3
Solid
Size:12cm
solid handle
style as
No.4

01-2194
No. 3
Solid
Size:12cm
cm-graduation

01-2195
No. 3 L
Straight
Solid, long
Size:21.5cm

01-2196
No. 3 L
Angled
Solid, long
Size:21cm

01-2197
No. 7
Solid
Size:16cm

01-2198
No. 7 K
Solid, short
Size:12.5cm

01-2199
No.3
Size:15.5cm
with round
hollow handle

01-2200
No. 3
Straight
Solid,
Round
Size:14.5cm

01-2201
No. 3
Angled
Solid, Round
Size:14cm



1/2

01-2202
SCHINK
 Size: 310 mm
 Complete with 2
 skin fixing plates
 and 1 blade.
 Adjustable from
 0.1 to 2.0mm



1/2

01-2203
SCHINK
 Spare Blade



1/2

01-2204
SCHINK
 Skin Fixing Plate



1/2

01-2205
SILVER
 Size: 190 mm
 For Usual
 Razor Blades



1/2

01-2206
 Size: 75 mm
 Cutting Length



1/2

01-2207
 Size: 80 mm
 Cutting Length

Micro Scissors, "Spring Type" Flat Handles

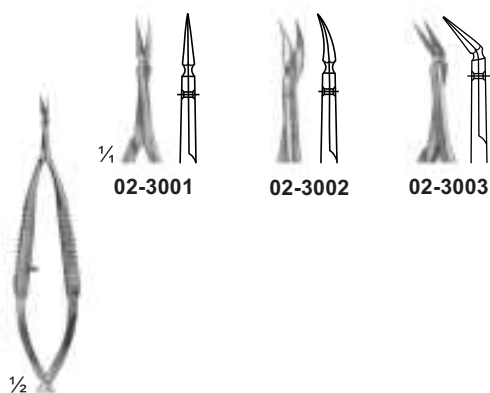

02-3001 - 02-3003
VANNAS
Size: 85 mm



02-3004 - 02-3005
CASTROVIEJO
Size: 95 mm

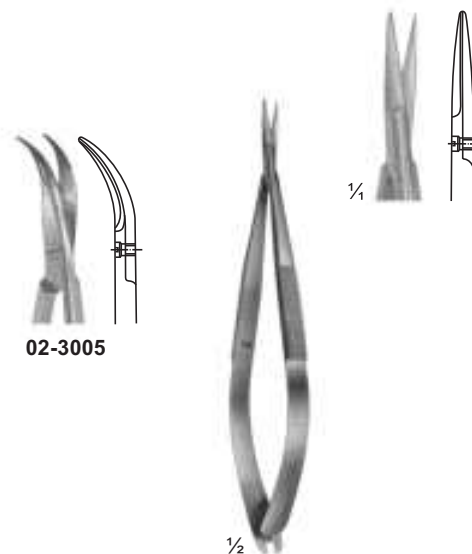

02-3006
NOYES
Size: 125 mm

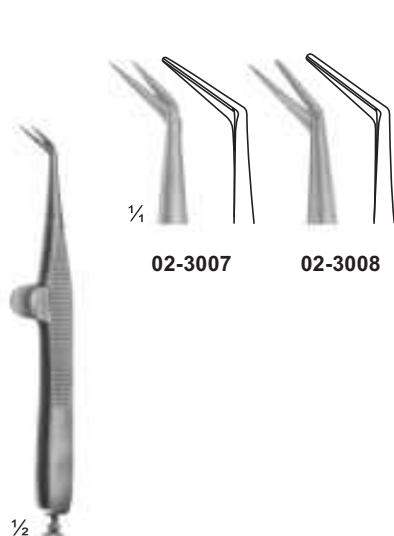

02-3007 - 02-3008
WECKER
Eye Scissor
Size: 110 mm

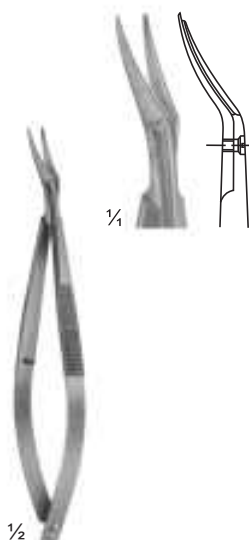

02-3009
CASTROVIEJO
Eye Scissor
Size: 115 mm

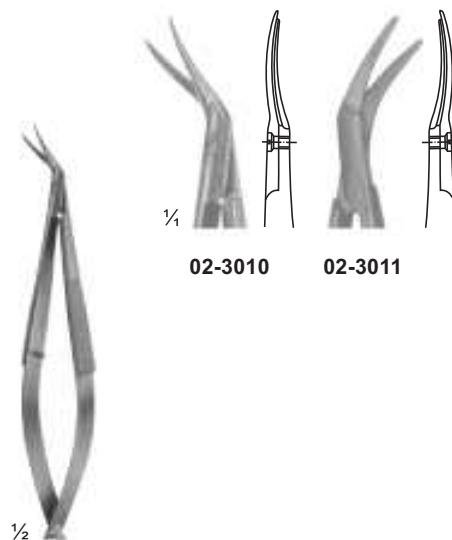

02-3010 - 02-3011
CASTROVIEJO
Eye Scissor
Size: 110 mm

Micro Scissors, "Spring Type" Flat Handles and Cross-Serration

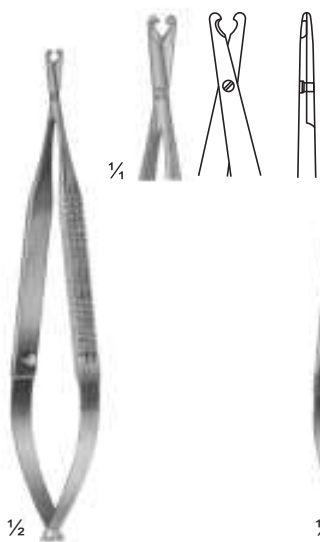

02-3012
BIEMER
Vein Scissor
Size: 130 mm

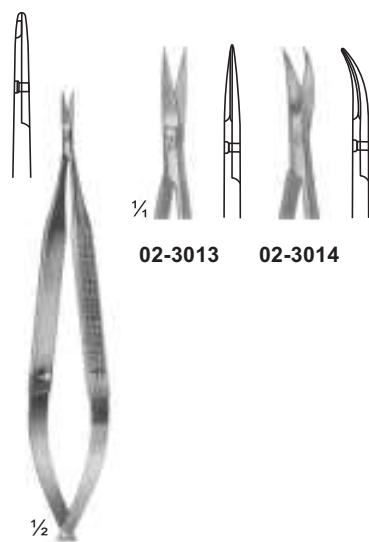

02-3013 - 02-3014
Size: 120 mm



02-3015 - 02-3016
Size: 160 mm

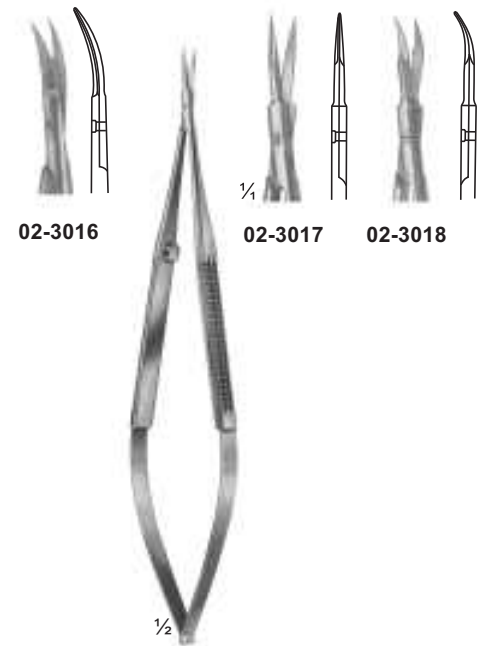

02-3017 - 02-3018
VANNAS
Size: 160 mm

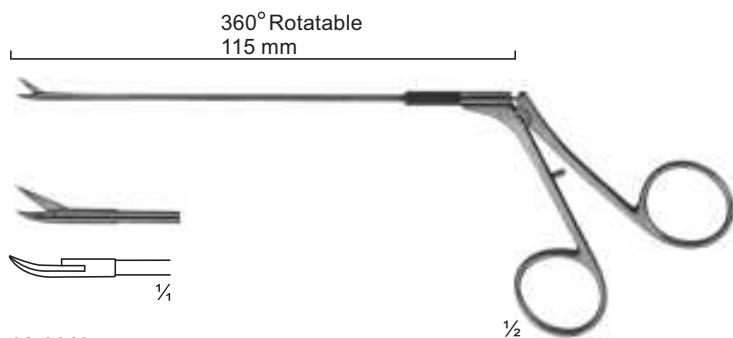

02-3019
CASPAR
Micro Scissor Curved

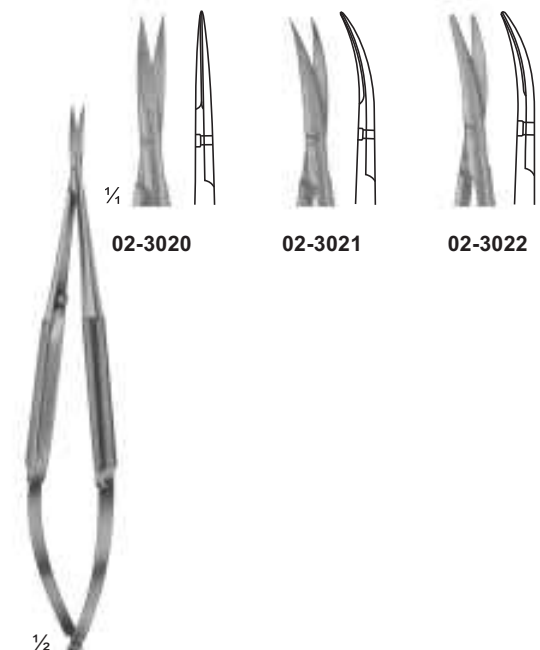

02-3020 - 02-3022
Micro Dissecting Scissor
Size: 145 mm

Micro Scissors, "Spring Type" Bayonet Shape



02-3023
YASARGIL
Size: 245 mm



02-3024
45°
Nagel



02-3025
45°



125°

02-3026
Laterally Angled
Size: 190 mm

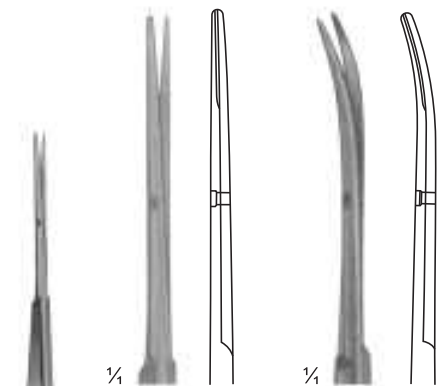

02-3027

02-3028



02-3027 - 02-3028
YASARGIL
Size: 225 mm

Delicate Scissors

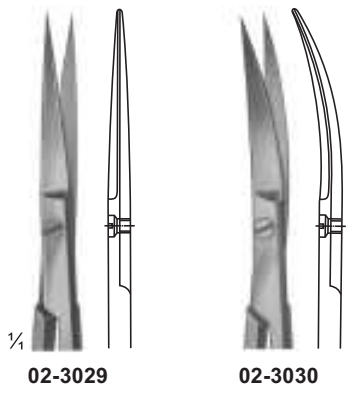
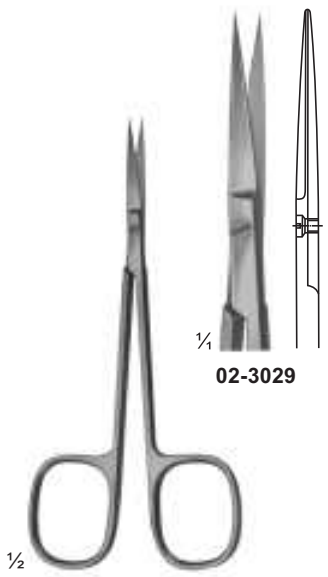

02-3029-02-3030
Size: 120 mm

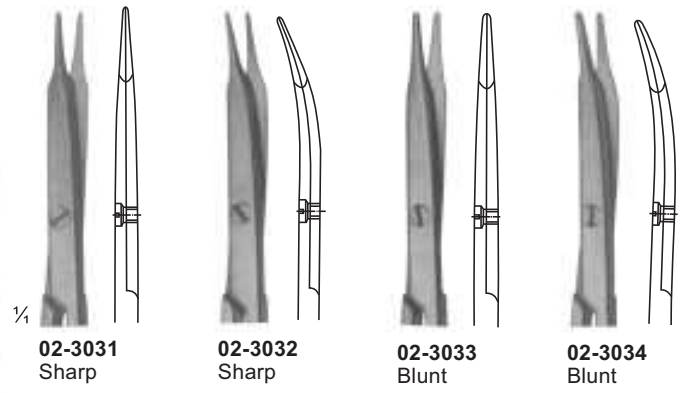
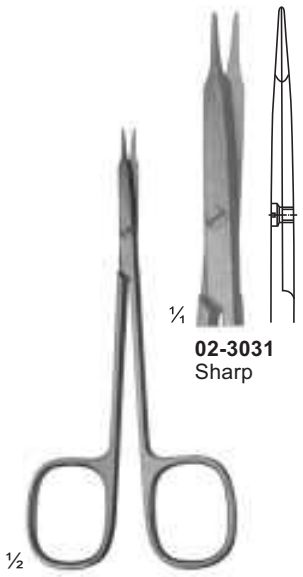

02-3031 - 02-3034
STEVENS
Dissecting Scissors
Size: 115 mm

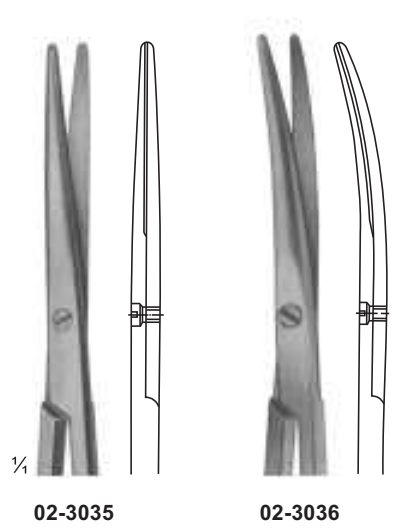
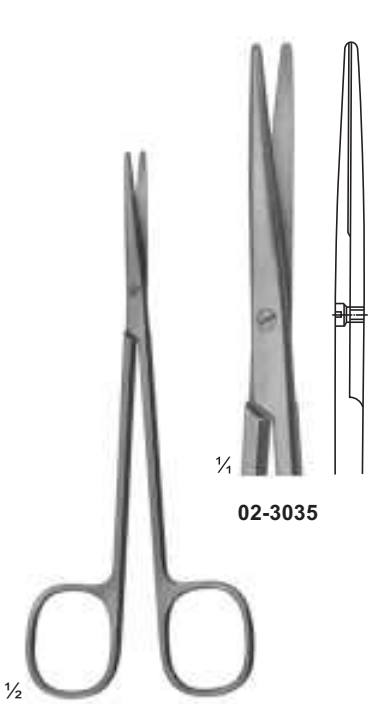

02-3035 - 02-3036
METZENBAUM
Dissecting Scissors
Size: 145 mm

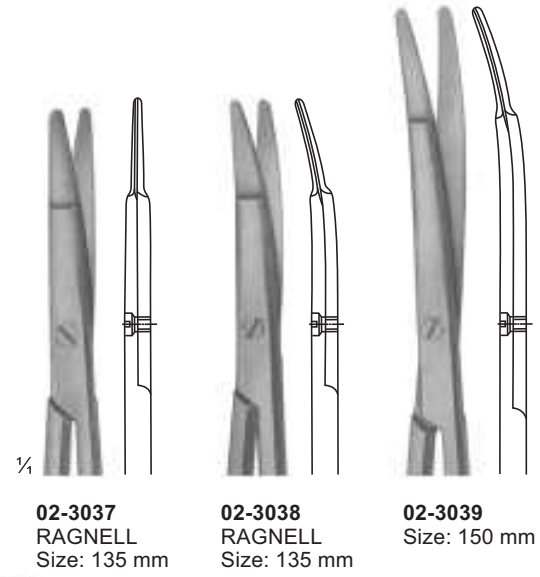
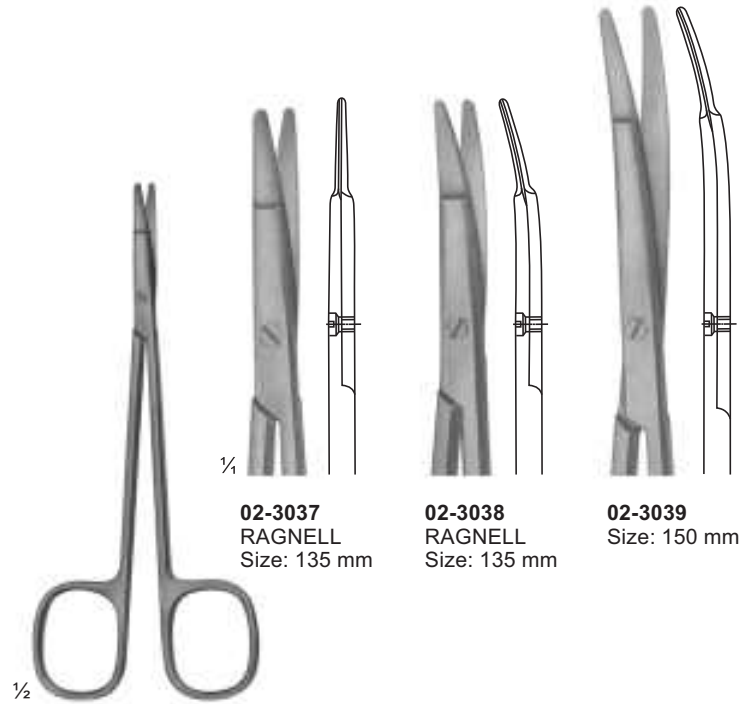

02-3037 - 02-3039
Special flat points for
dissecting and
undermining the skin

Delicate Scissors

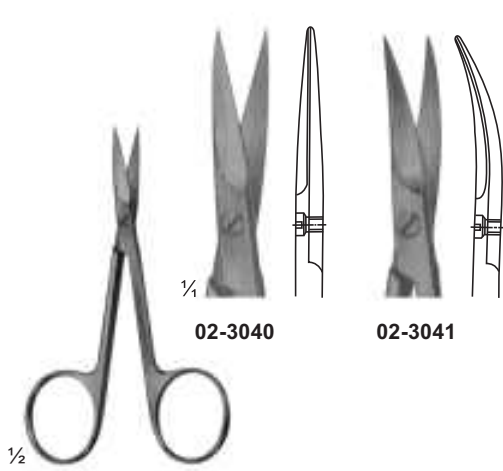

02-3040 - 02-3041
Size: 90 mm

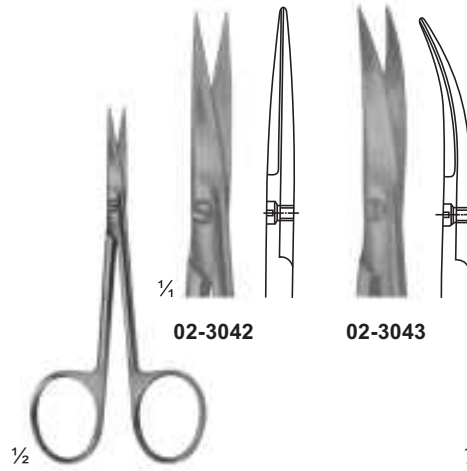

02-3042 - 02-3043
Size: 95 mm

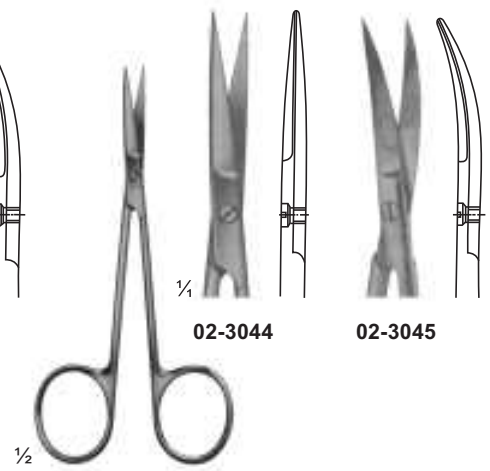

02-3044 - 02-3045
Size: 105 mm

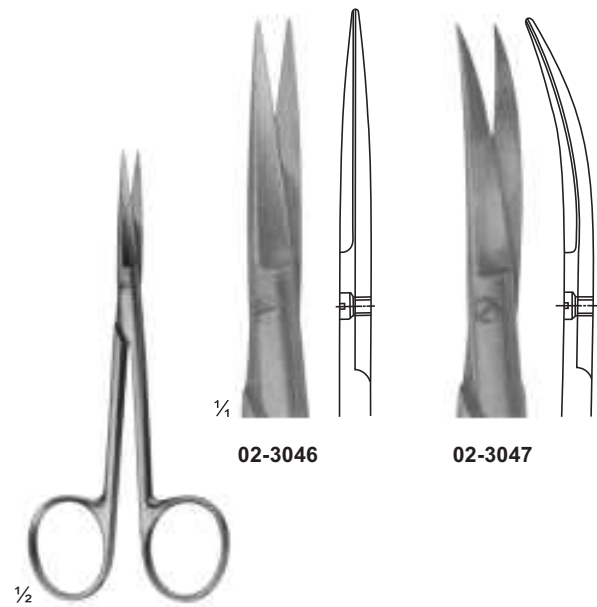

02-3046 - 02-3047
Size: 120 mm

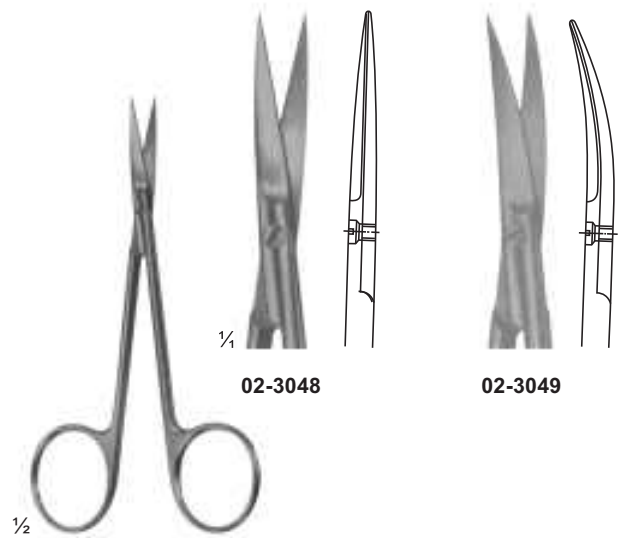

02-3048 - 02-3049
Size: 115 mm

Delicate Scissors



1/2

02-3050 - 02-3052
Size: 120 mm

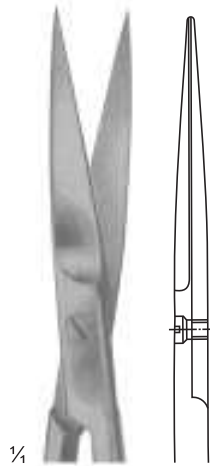

1/4

02-3050

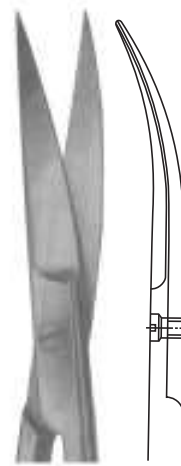

02-3051

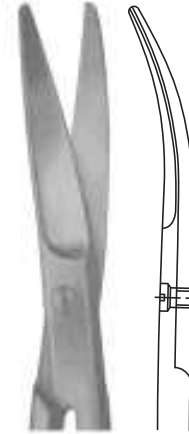

02-3052



1/2

02-3053 - 02-3056
Size: 130 mm

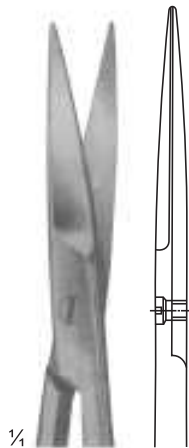

1/4

02-3053

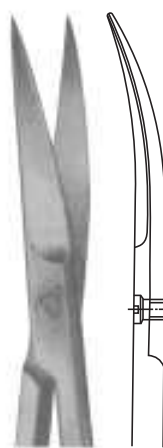

02-3054

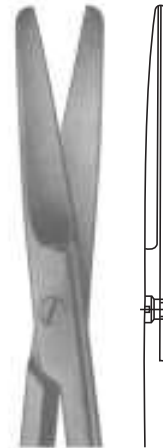

02-3055

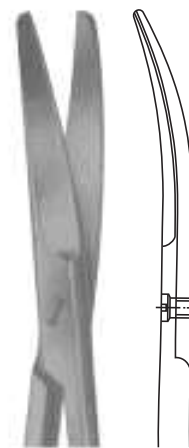

02-3056

Delicate Scissors

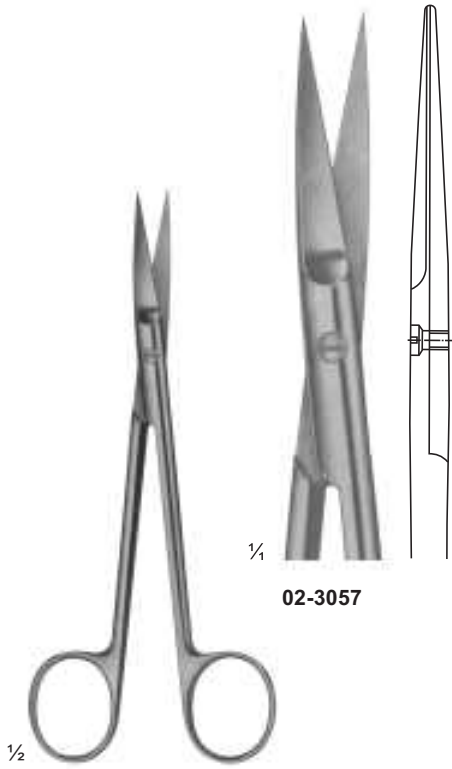

02-3057

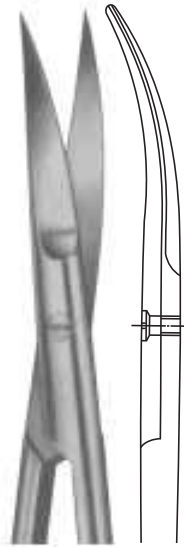

02-3058

02-3057 - 02-3058
JOSEPH
Size: 150 mm

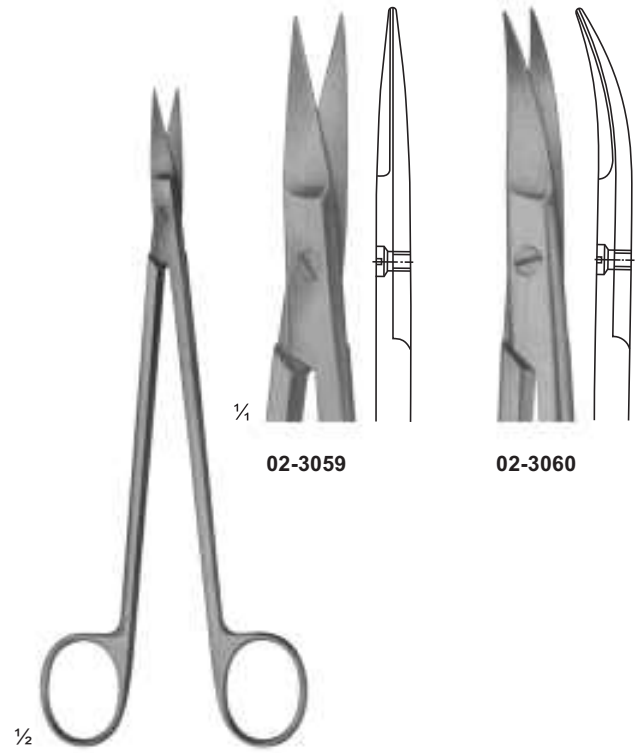

02-3059

02-3060

02-3059 - 02-3060
KELLY
Size: 175 mm

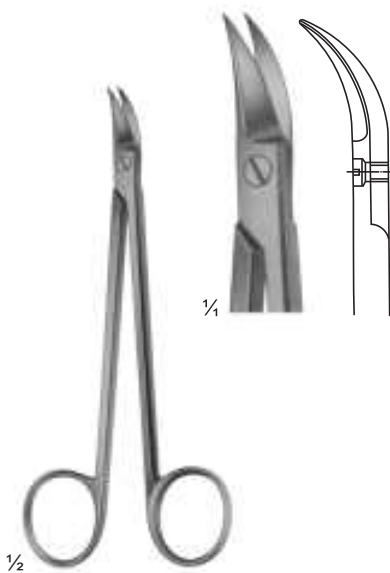

02-3061
QUINBY
Size: 130 mm

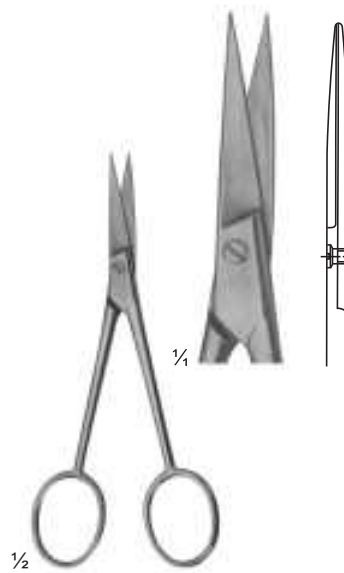

02-3062
Size: 110 mm

Surgical Scissors

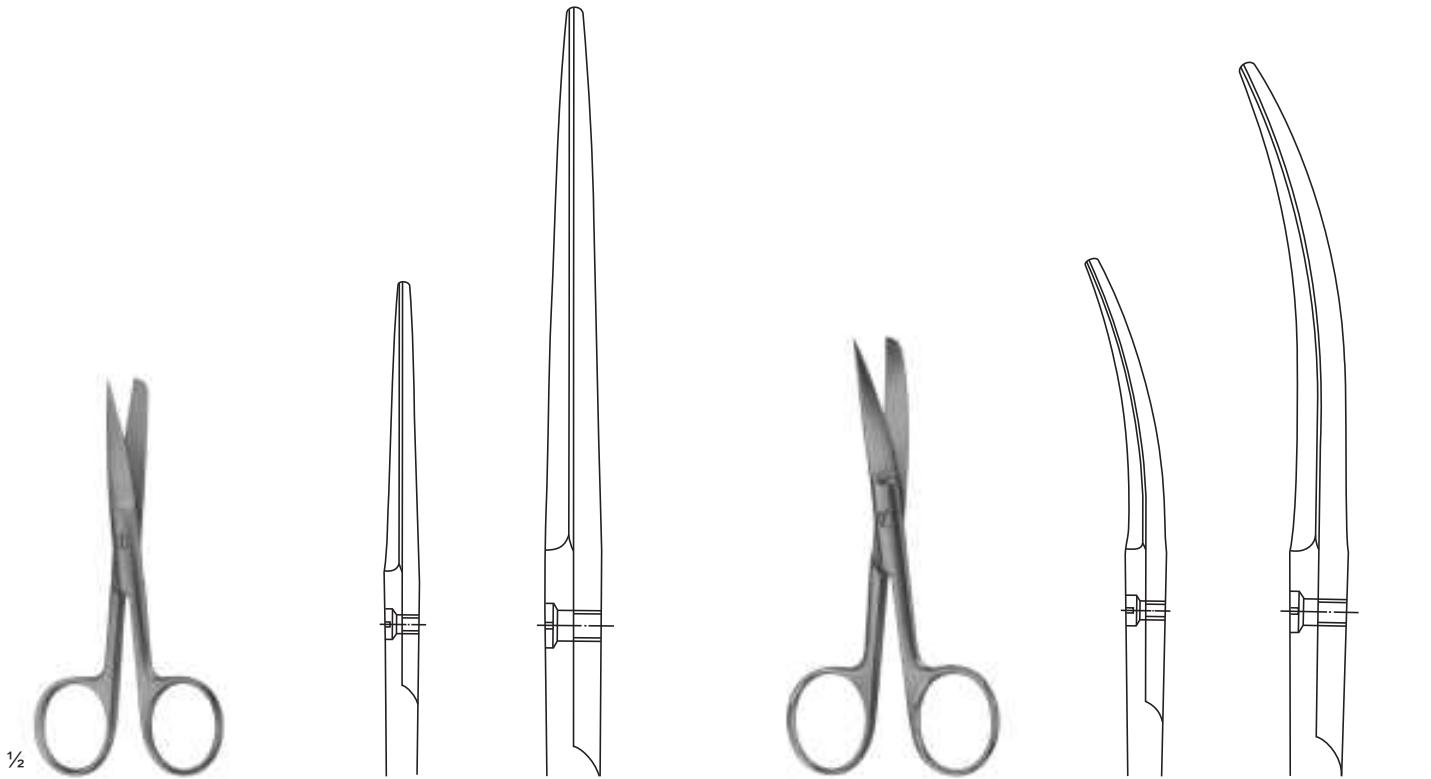

02-3063 - 02-3071 (Standard Types)
02-3063 (105 mm)
02-3064 (115 mm)
02-3065 (130 mm)
02-3066 (145 mm)
02-3067 (150 mm)
02-3068 (165 mm)
02-3069 (175 mm)
02-3070 (185 mm)
02-3071 (200 mm)

02-3063
 Size: 105 mm

02-3071
 Size: 200 mm

02-3072 - 02-3078 (Standard Types)
02-3072(115 mm)
02-3073 (130 mm)
02-3074 (145 mm)
02-3075 (150 mm)
02-3076 (165 mm)
02-3077 (175 mm)
02-3078(185 mm)

02-3072
 Size: 115 mm

02-3078
 Size: 185 mm

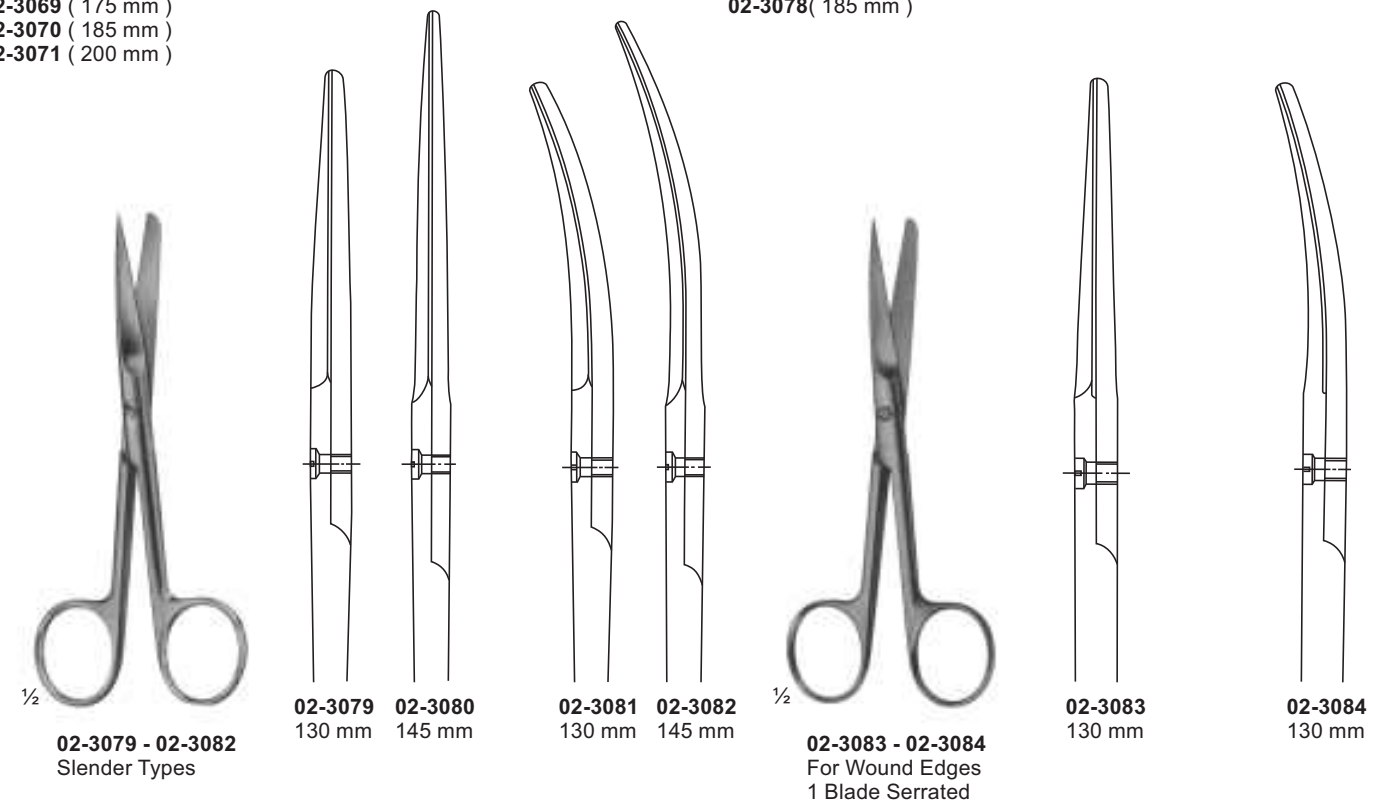

02-3079 - 02-3082
 Slender Types

02-3079 130 mm
02-3080 145 mm

02-3081 130 mm
02-3082 145 mm

02-3083 - 02-3084
 For Wound Edges
 1 Blade Serrated

02-3083
 130 mm

02-3084
 130 mm

Surgical Scissors

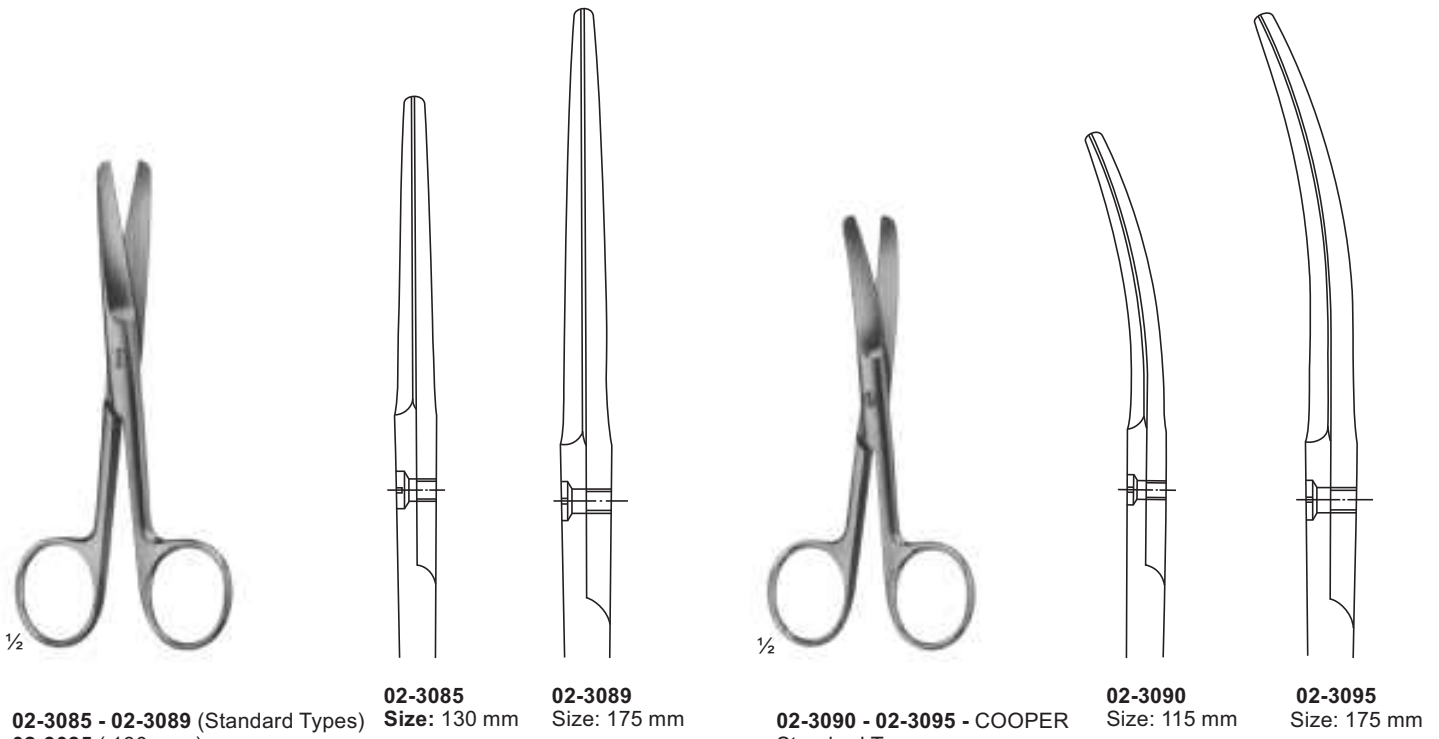

02-3085 - 02-3089 (Standard Types)
02-3085 (130 mm)
02-3086 (145 mm)
02-3087 (150 mm)
02-3088 (165 mm)
02-3089(175 mm)

02-3085 Size: 130 mm
02-3089 Size: 175 mm

02-3090 - 02-3095 - COOPER
 Standard Types
02-3090 (115 mm)
02-3091 (130 mm)
02-3092 (145 mm)
02-3093 (150 mm)
02-3094 (165 mm)
02-3095 (175 mm)

02-3090 Size: 115 mm
02-3095 Size: 175 mm

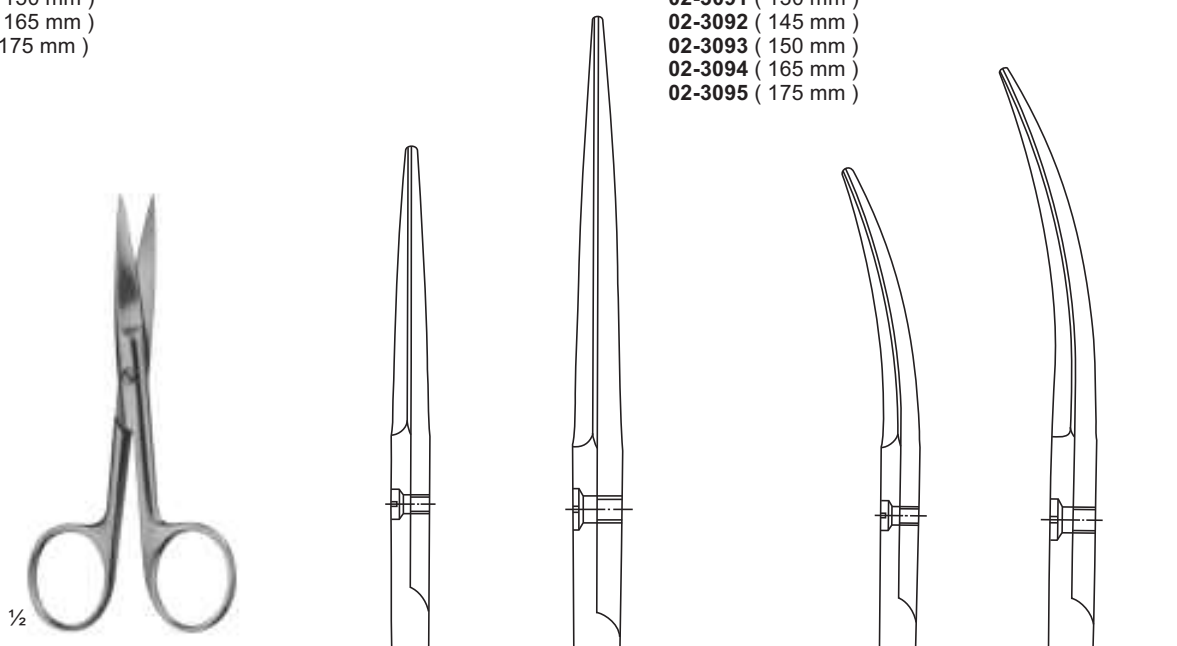

02-3096 - 02-3102A
 Standard Types
02-3096 (115 mm)
02-3097 (130 mm)
02-3098 (145 mm)
02-3099 (150 mm)
02-3100 (165 mm)

02-3096 Size: 115 mm
02-3100 Size: 165 mm

02-3100A Size: 115 mm
02-3102A Size: 165 mm

02-3100A (115 mm)
02-3101 (130 mm)
02-3101A (145 mm)
02-3102 (150 mm)
02-3102A (165 mm)

Surgical Scissors

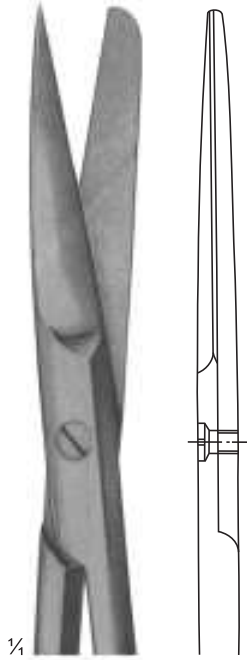

02-3103
Size: 145 mm

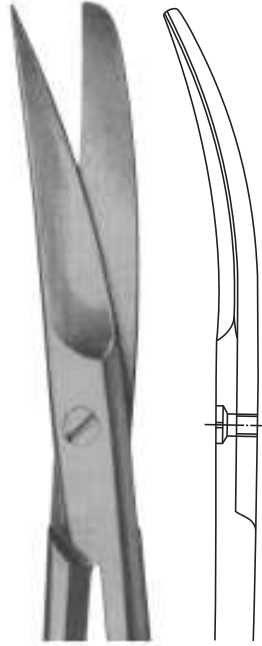

02-3104
Size: 145 mm

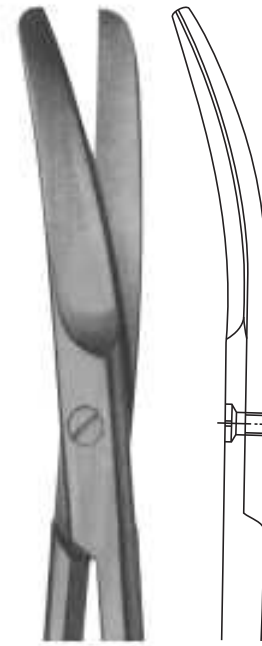

02-3105
Size: 145 mm

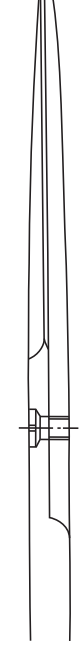

02-3106
Size: 145 mm

02-3103 - 02-3106
DEAVER
With flat lock

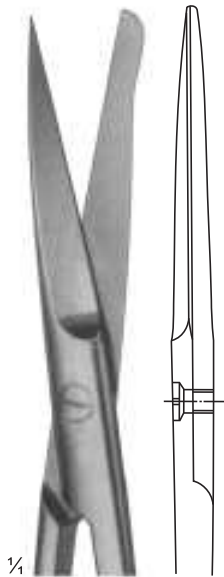

02-3107
Size: 130 mm



02-3108
Size: 145 mm

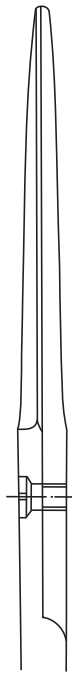

02-3109
Size: 165 mm



02-3110
Size: 130 mm

02-3107 - 02-3109
Incision Scissors

02-3110
SYSTRUNK
Nail Splitting Scissors

Dissecting Scissors

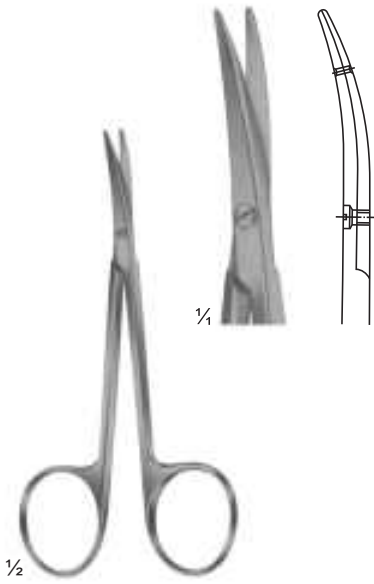

02-3111
LITTLER
Dissecting Scissors
Tips with eye for suture
Size: 115 mm

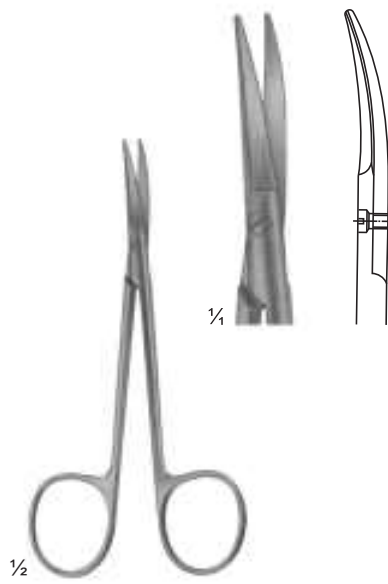

02-3112
COTTLE
Bulldog Scissors
Size: 115 mm

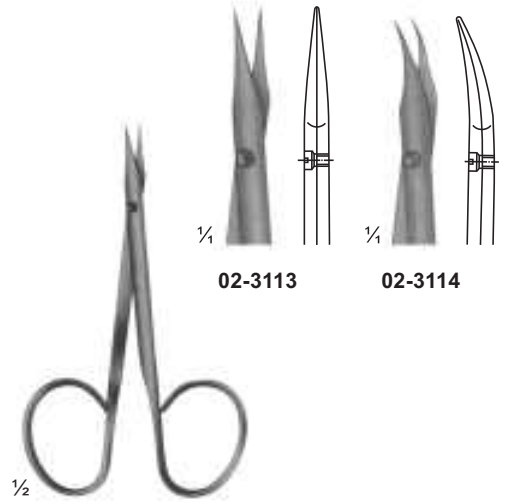

02-3113 - 02-3114
STEVENS
Vessel and tendon Scissors
Size: 100 mm

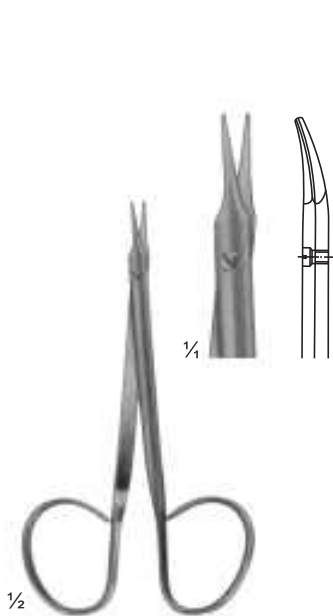

02-3115
STEVENS
Fine Dissecting Scissors
Size: 110 mm

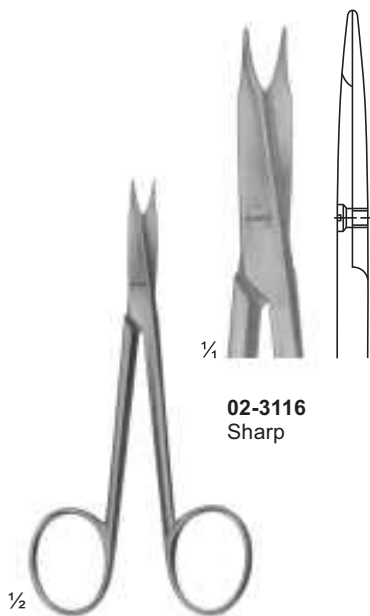

02-3116 - 02-3119
STEVENS
Vessel and tendon Scissors
Size: 110 mm

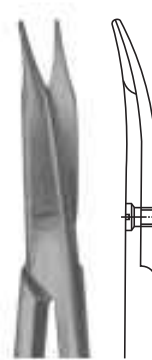

02-3117
Sharp

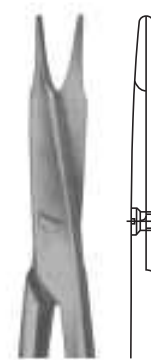

02-3118
Blunt

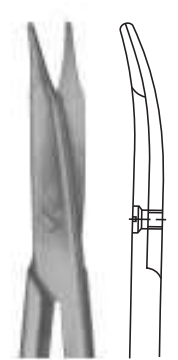

02-3119
Blunt

Dissecting Scissors

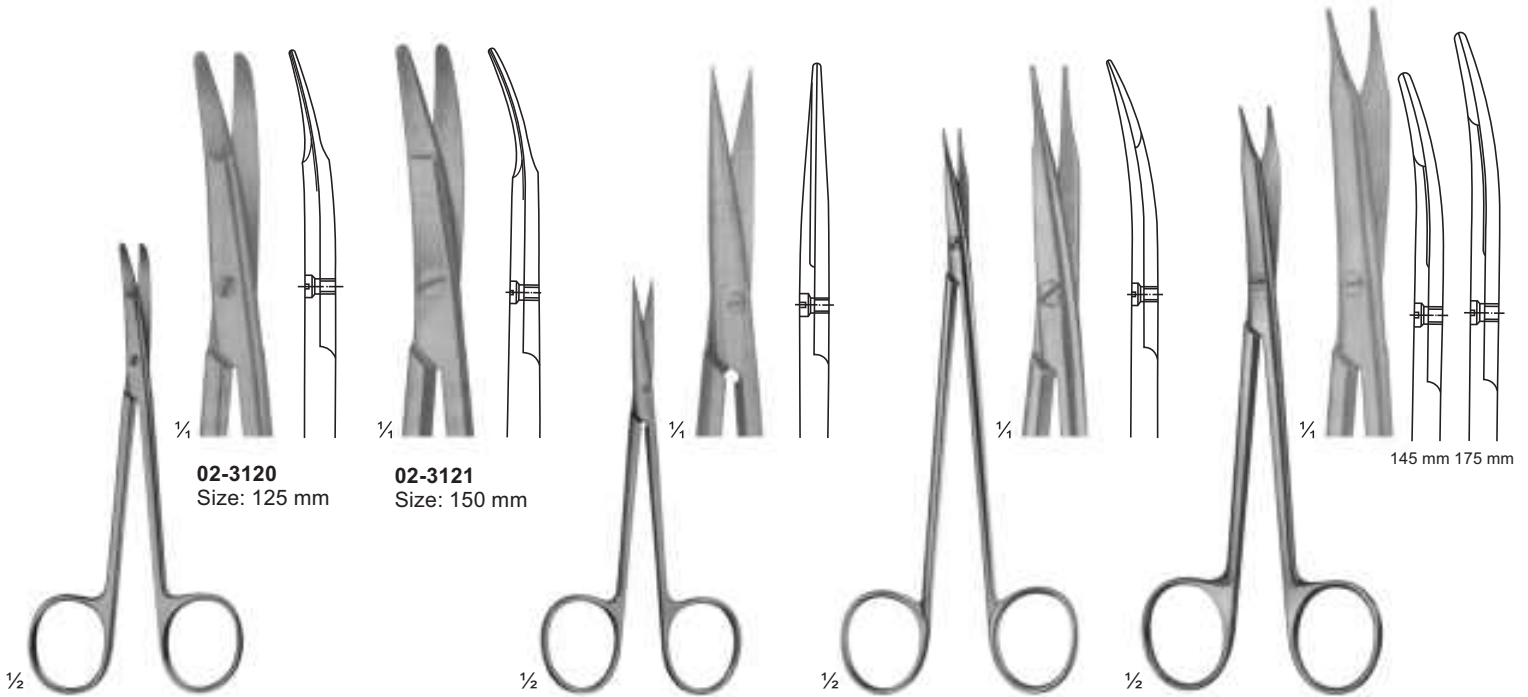

02-3120 - 02-3121
KILNER
 Special flat points for dissecting and undermining the skin

02-3122
KILNER
 Fine dissecting scissors
 Size: 115 mm

02-3123
JAMESON
 Dissecting scissors
 Size: 150 mm

02-3124
REYNOLDS
 Dissecting scissors

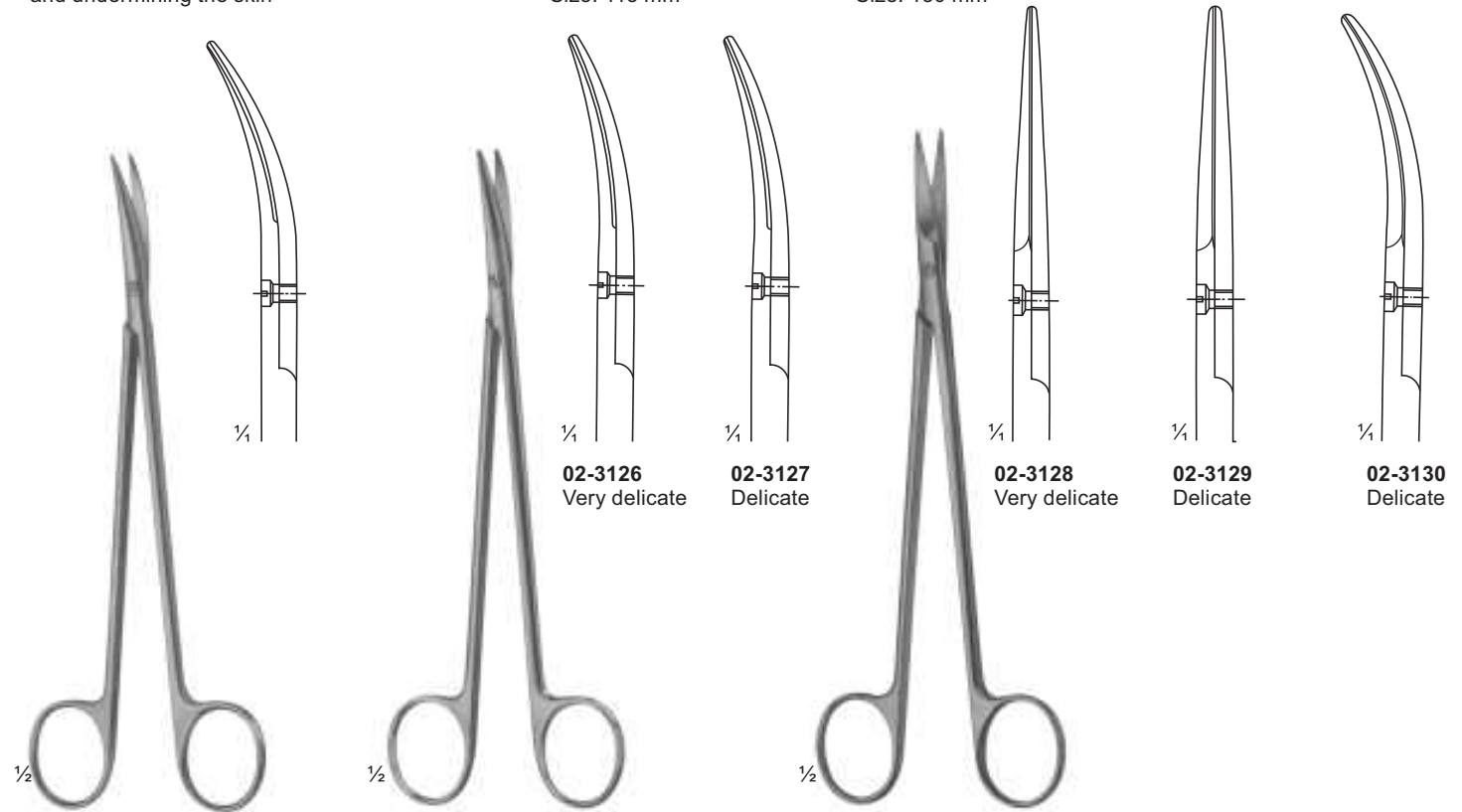

02-3125
DE BAKEY
 Ateriotomy scissors
 Size: 175 mm

02-3126 - 02-3127
TOENNIS - ADSON
 Dissecting scissors
 Size: 175 mm

02-3128 - 02-3130
TOENNIS
 Dissecting scissors
 Size: 180 mm

Dissecting & Surgical Scissors



02-3131
Size: 115 mm

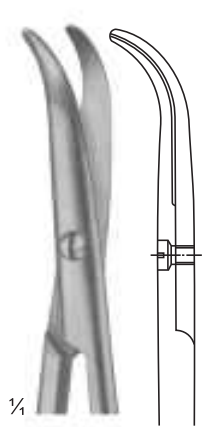

02-3132
Size: 135 mm

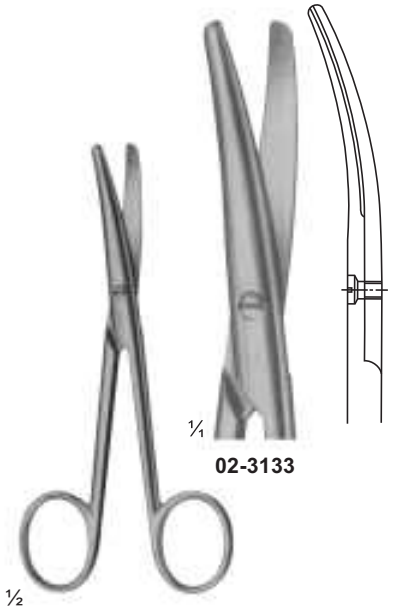

02-3133

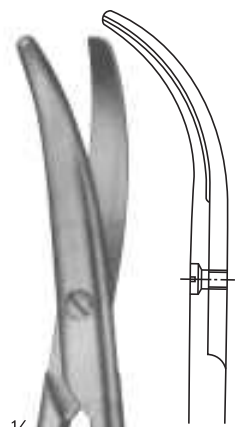

02-3134

02-3133 - 02-3134
LANDOLT
Enucleation scissors
Size: 120 mm

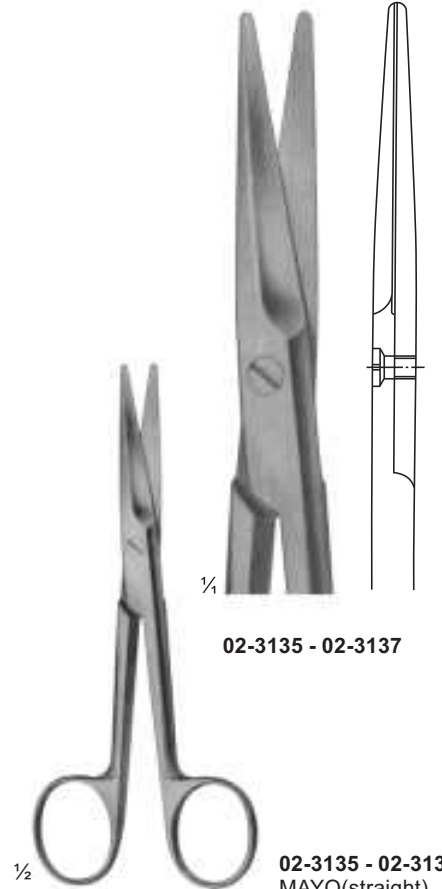

02-3135 - 02-3137

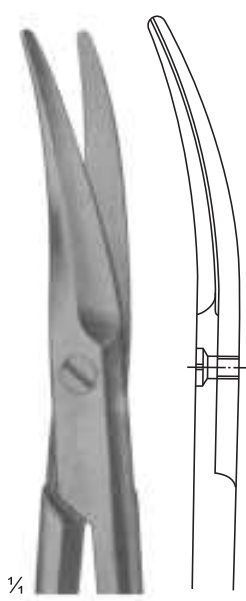

02-3138 - 02-3140
MAYO(curved)
02-3138 (140 mm)
02-3139 (155 mm)
02-3140 (170 mm)

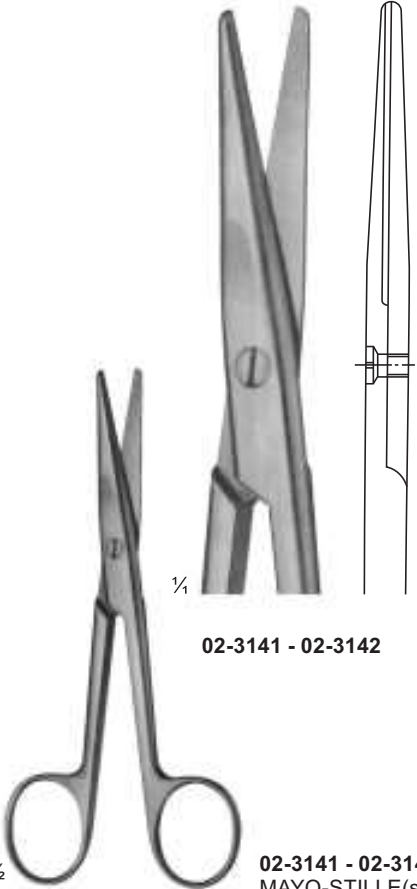

02-3141 - 02-3142

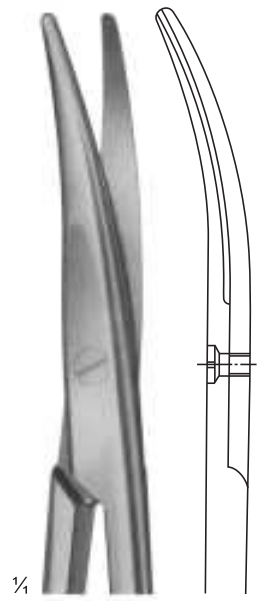

02-3143 - 02-3144
MAYO-STILLE(curved)
02-3143 (140 mm)
02-3144 (170 mm)

02-3135 - 02-3137
MAYO(straight)
02-3135 (140 mm)
02-3136(155 mm)
02-3137 (170 mm)

02-3141 - 02-3142
MAYO-STILLE(straight)
02-3141 (140 mm)
02-3142 (170 mm)

Dissecting Scissors

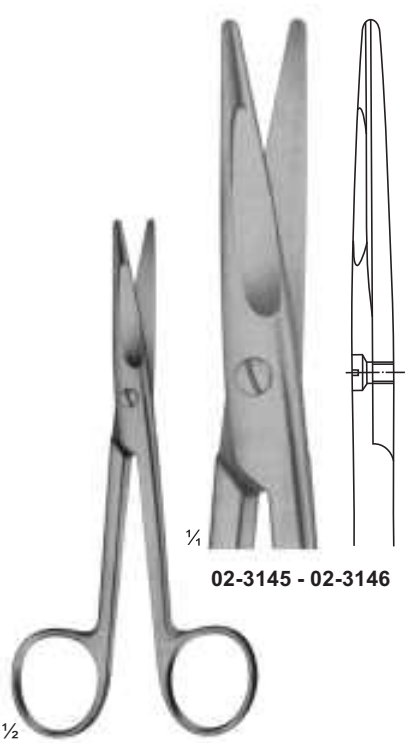

02-3145 - 02-3146

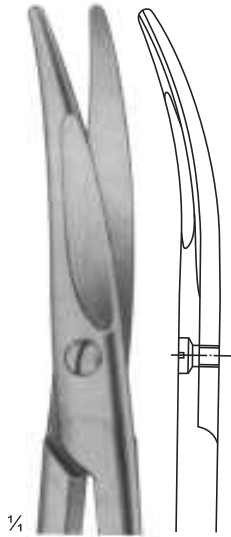

MAYO-STILLE
02-3147 - 02-3148
02-3147 (14cm)
02-3148 (17cm)

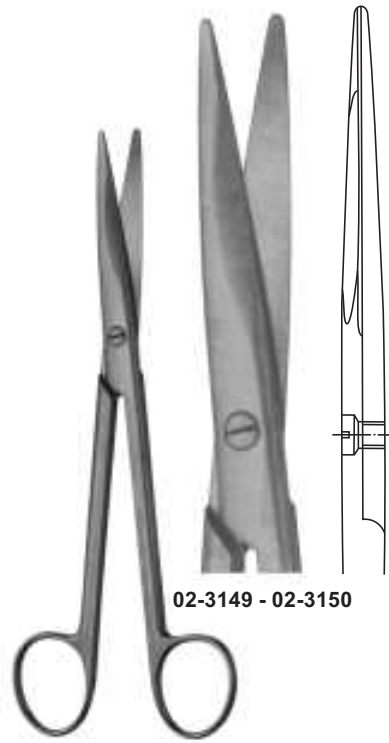

02-3149 - 02-3150

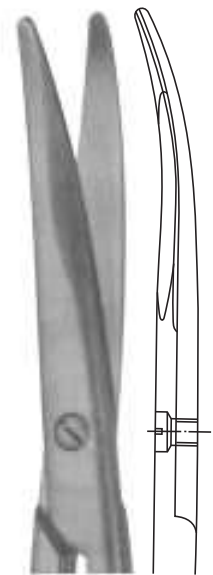

MAYO
02-3151
 Size: 190 mm
02-3152
 Size: 215 mm

1/2
02-3145 - 02-3146
MAYO-STILLE
 With chamfered blades
02-3145 (140 mm)
02-3146 (170 mm)

MAYO
 With chamfered blades
02-3149 (190 mm)
02-3150 (215 mm)

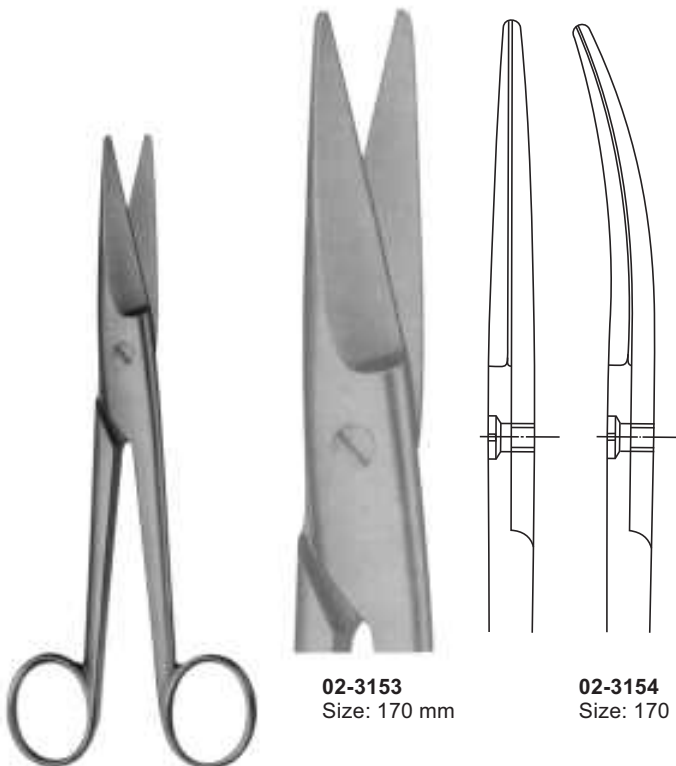

02-3153
 Size: 170 mm

02-3154
 Size: 170 mm

02-3153 - 02-3154
MAYO-NOBLE (Broad pattern)

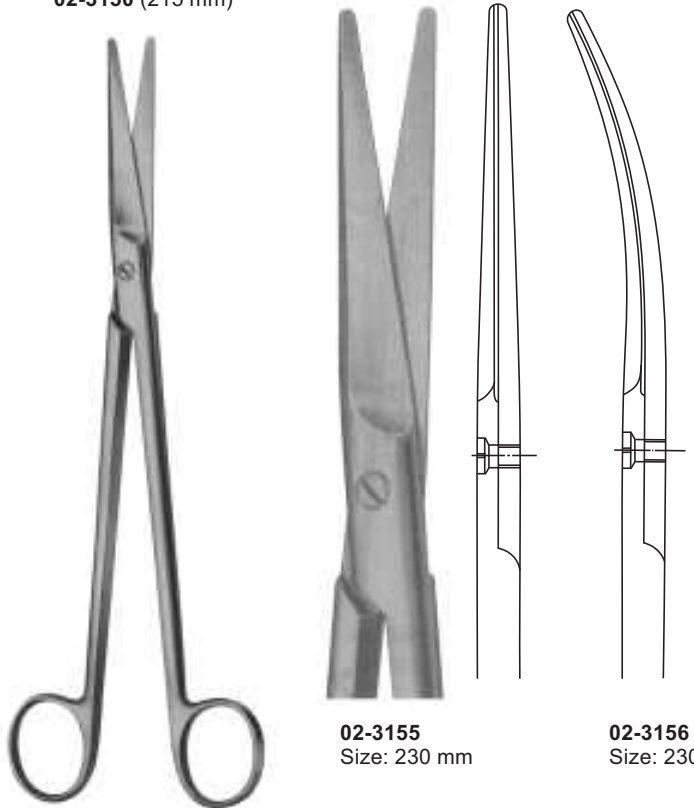

02-3155
 Size: 230 mm

02-3156
 Size: 230 mm

02-3155 - 02-3156
MAYO-HARRINGTON

Dissecting Scissors

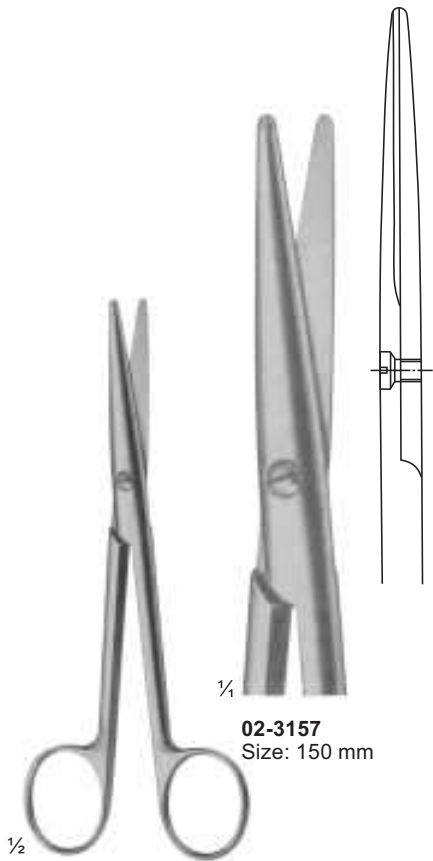

02-3157
Size: 150 mm

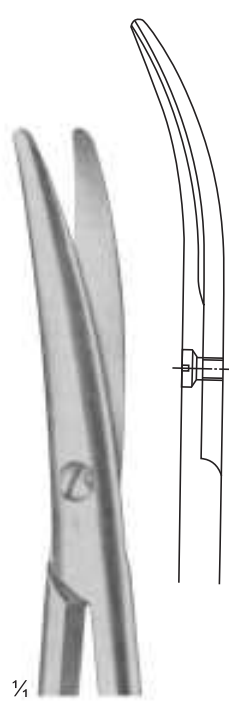

02-3158
Size: 150 mm

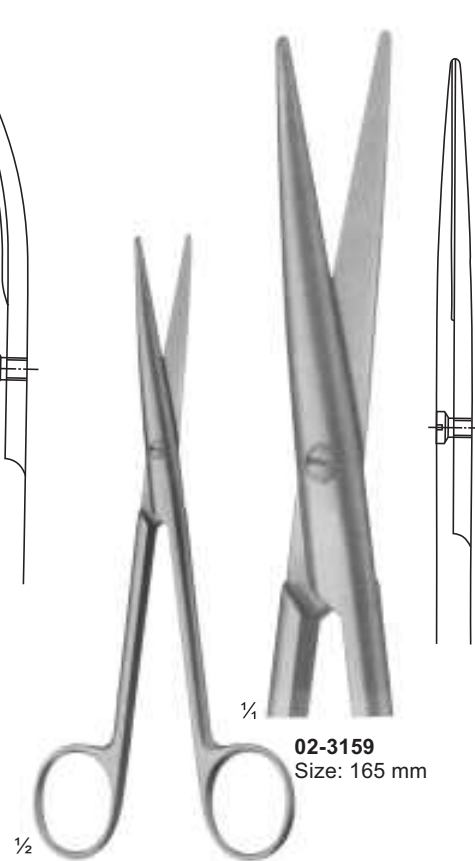

02-3159
Size: 165 mm

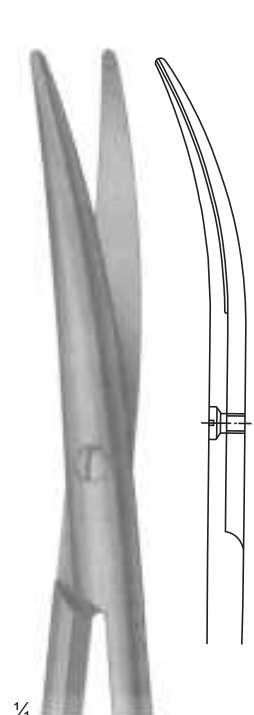

02-3160
Size: 165 mm

02-3157 - 02-3158
STILLE

02-3159 - 02-3160
LEXER
Narrow

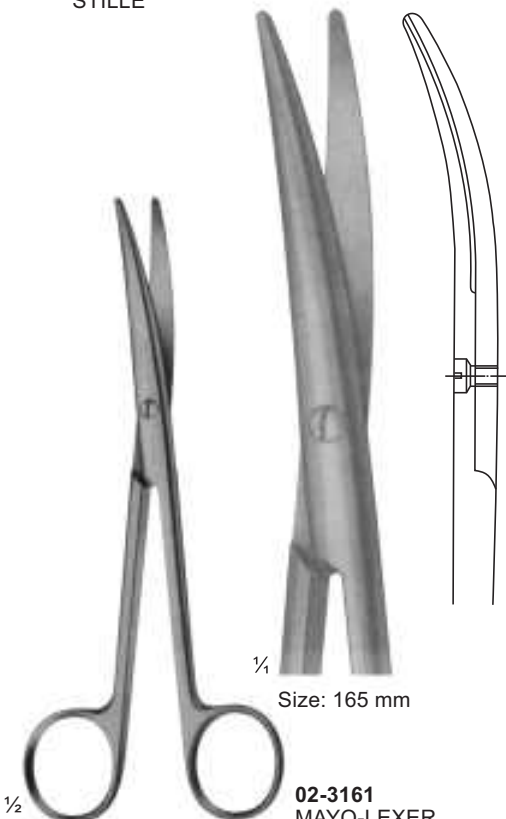

02-3161
MAYO-LEXER
Standard

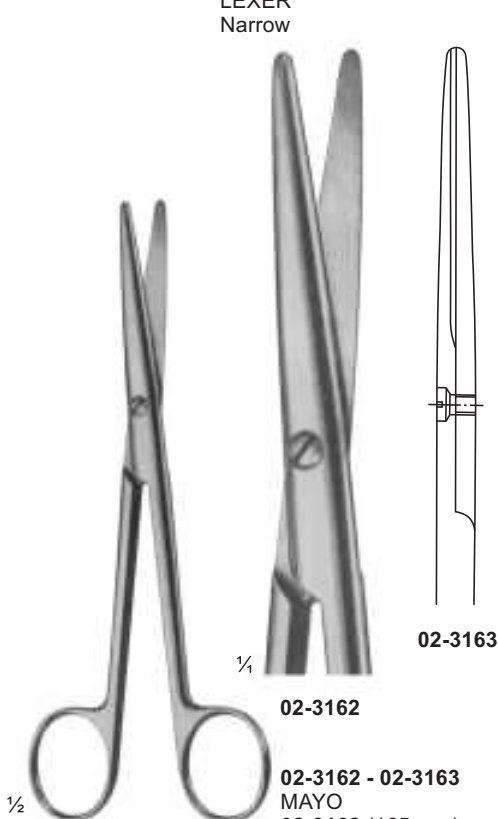

02-3162
02-3162 - 02-3163
MAYO
02-3162 (165 mm)
02-3163 (200 mm)

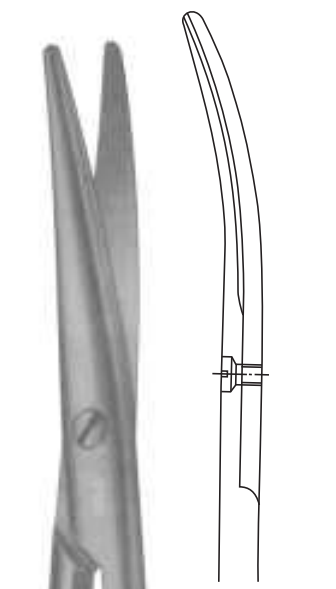

02-3164
MAYO
Size: 165 mm
02-3165
Size: 200 mm
02-3166
Size: 210 mm

Dissecting Scissors

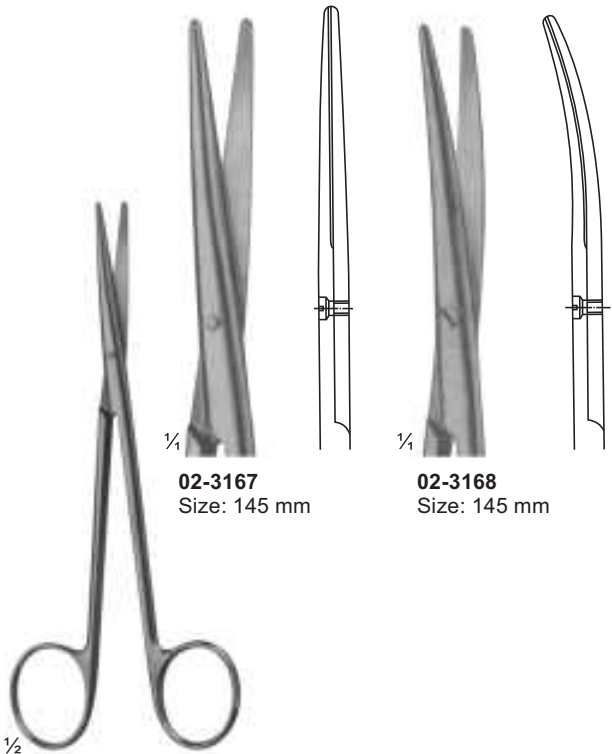

02-3167
Size: 145 mm

02-3168
Size: 145 mm

02-3167 - 02-3168
BABY - METZENBAUM

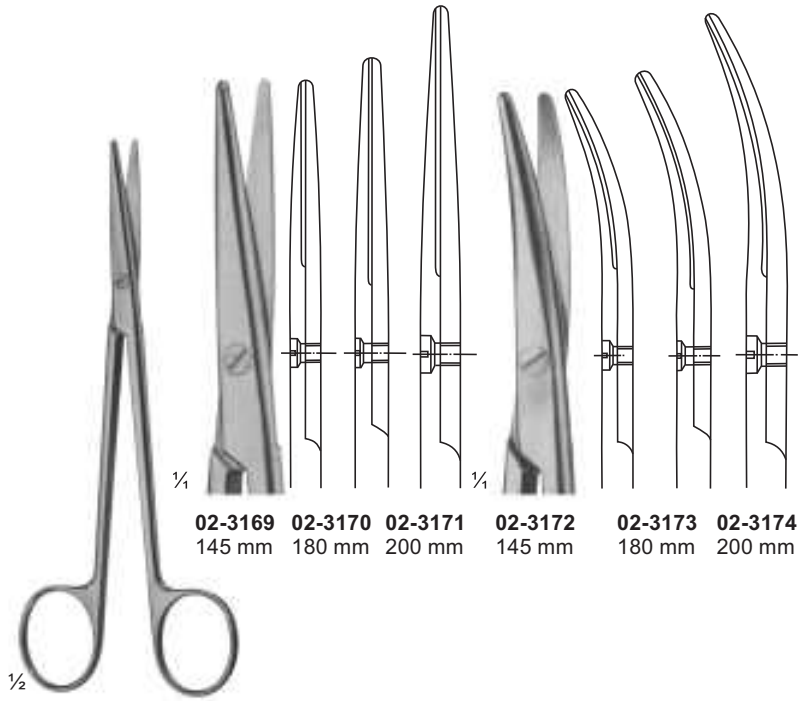

02-3169
145 mm

02-3170
180 mm

02-3171
200 mm

02-3172
145 mm

02-3173
180 mm

02-3174
200 mm

02-3169 - 02-3174
METZENBAUM



02-3175 - 02-3182
NELSON
METZENBAUM

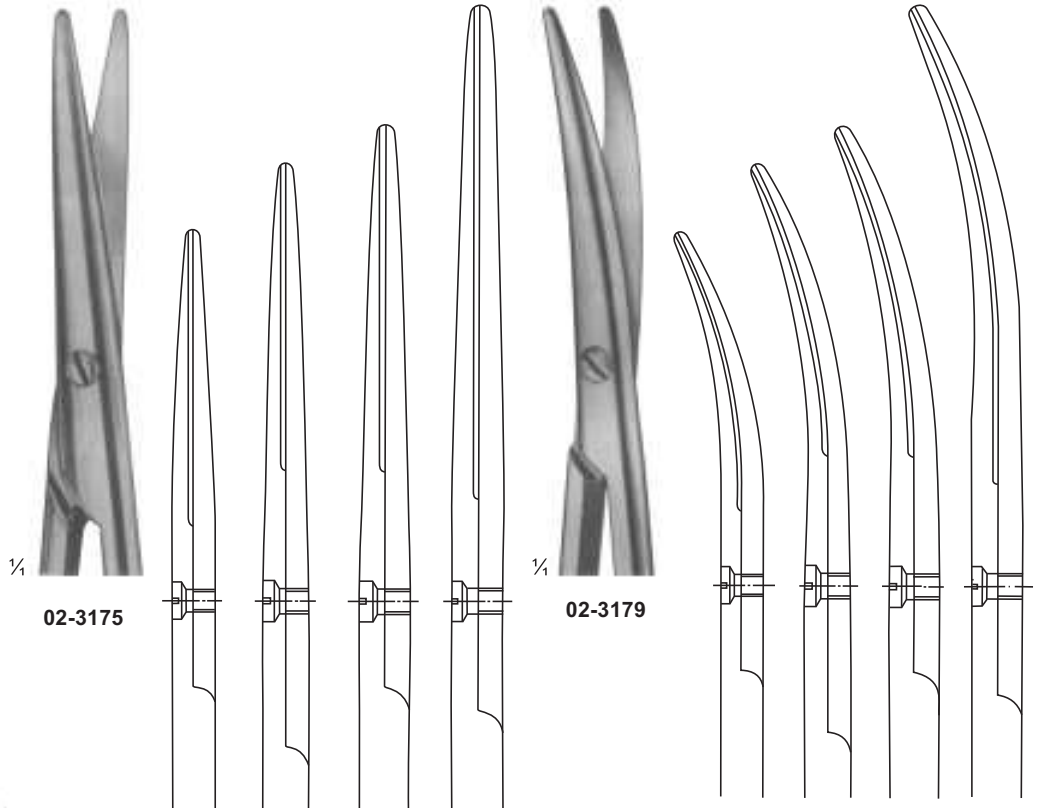

02-3175

02-3179

02-3175
230 mm

02-3176
250 mm

02-3177
280 mm

02-3178
305 mm

02-3179
230 mm

02-3180
250 mm

02-3181
280 mm

02-3182
305 mm

Vessel Scissors

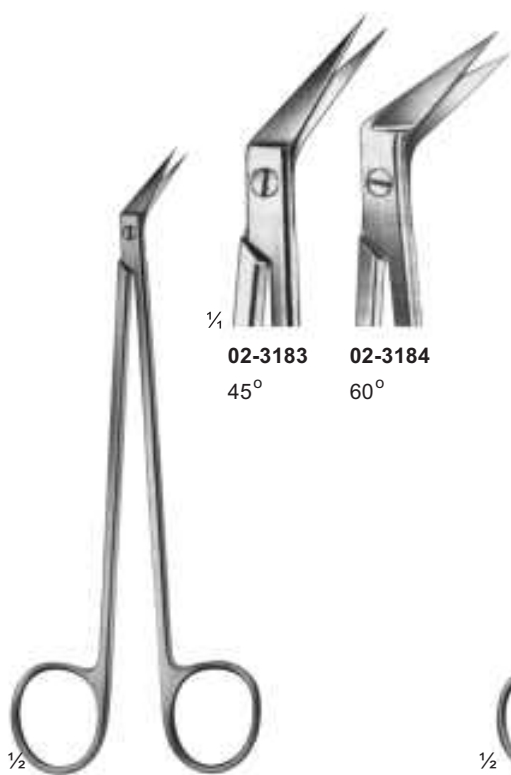

02-3183
45°

02-3184
60°

02-3183 - 02-3184
DE BAKHEY
Size: 155 mm

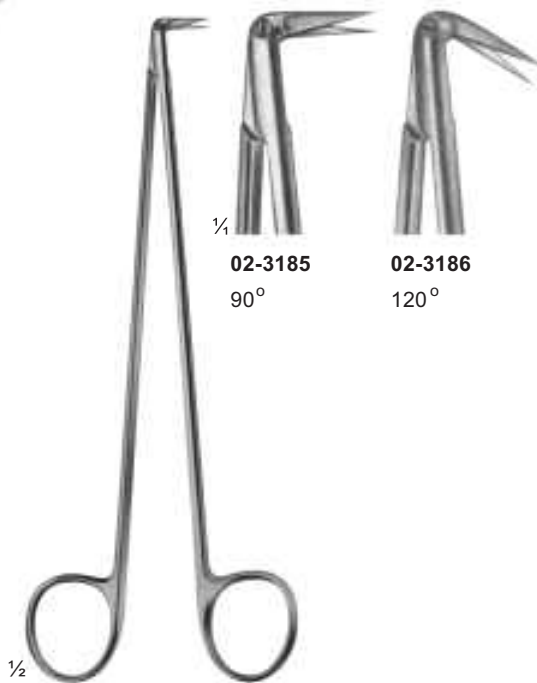

02-3185
90°

02-3186
120°

02-3185 - 02-3186
DIETRICH
Size: 170 mm

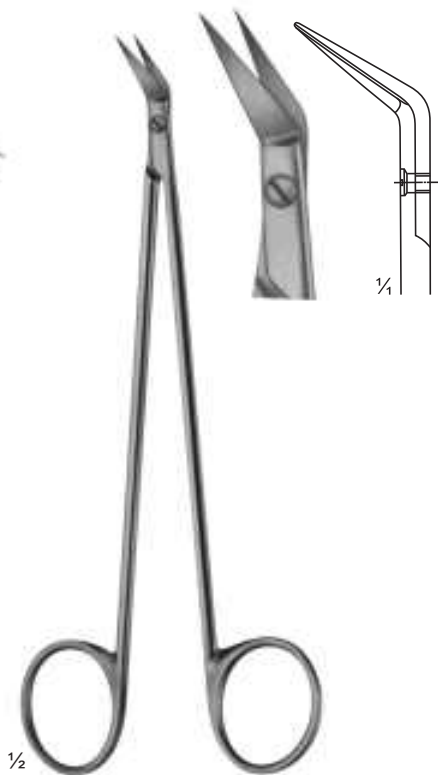

02-3187
POTTS-SMITH
Size: 180 mm
55° Angled on Flat

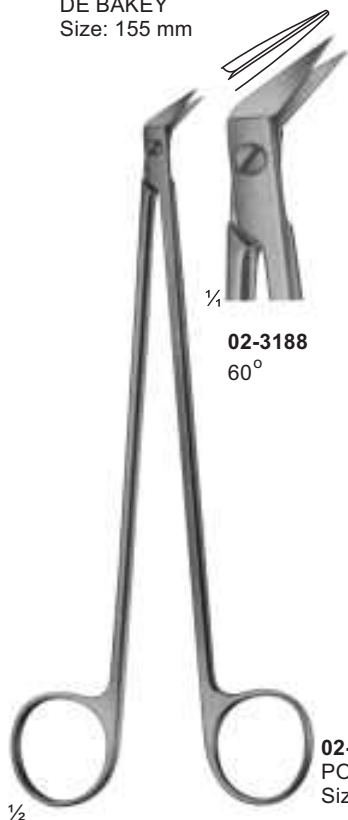

02-3188
60°

02-3188
POTTS-SMITH
Size: 180 mm

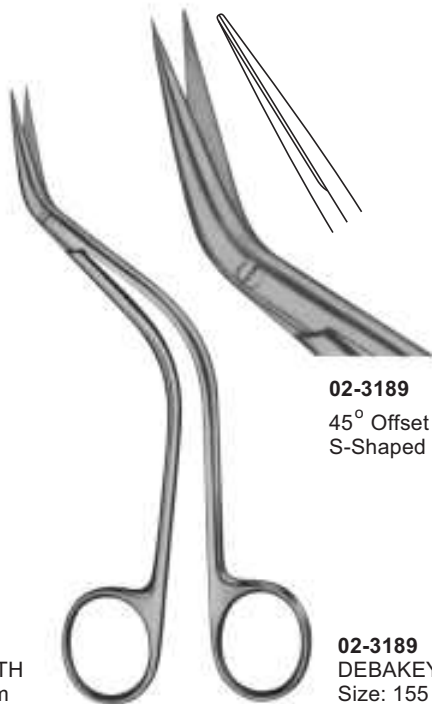

02-3189
45° Offset Scissors
S-Shaped

02-3189
DEBAKEY
Size: 155 mm



02-3190
55°

02-3190
FAVOLORO
Coronary Artery
Scissors
Size: 140 mm

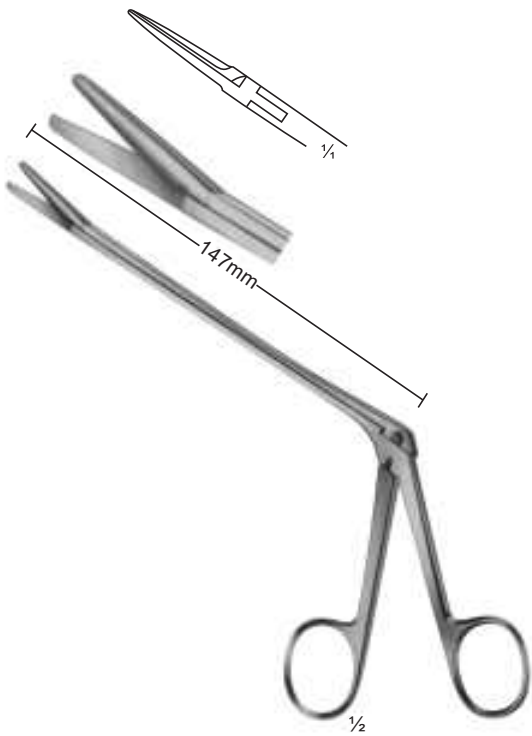

02-3191
OLIVECRONA
Dura Scissors



02-3192
STRULLY
Pointed
Size: 220 mm

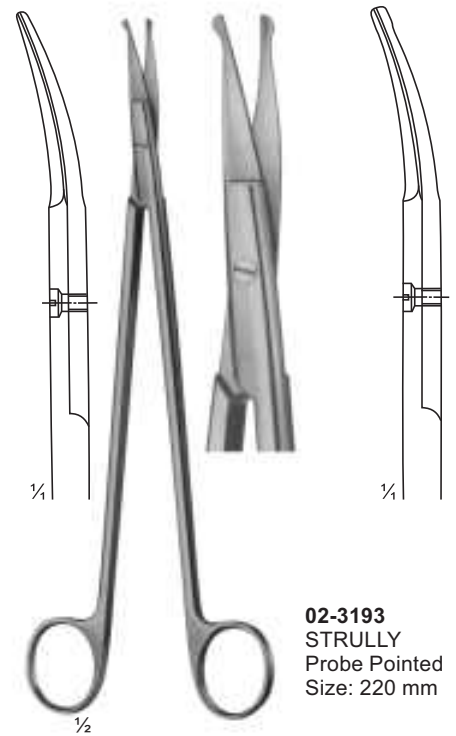

02-3193
STRULLY
Probe Pointed
Size: 220 mm

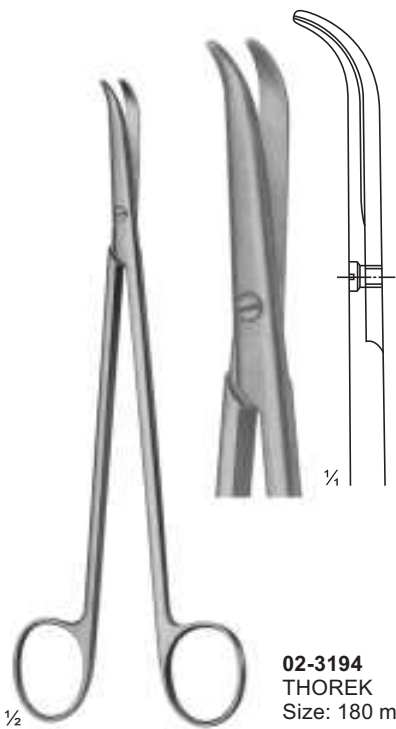

02-3194
THOREK
Size: 180 mm

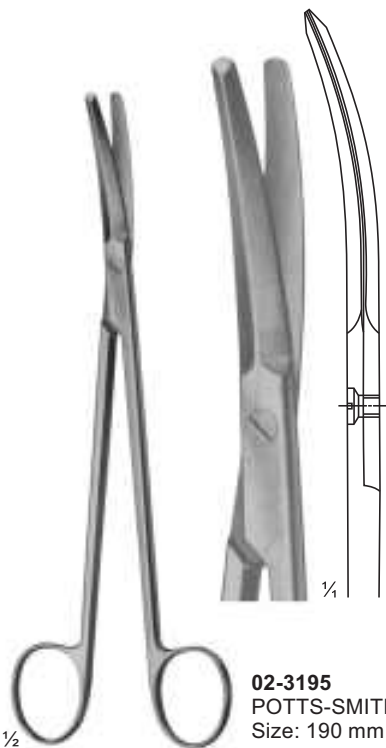

02-3195
POTTS-SMITH
Size: 190 mm

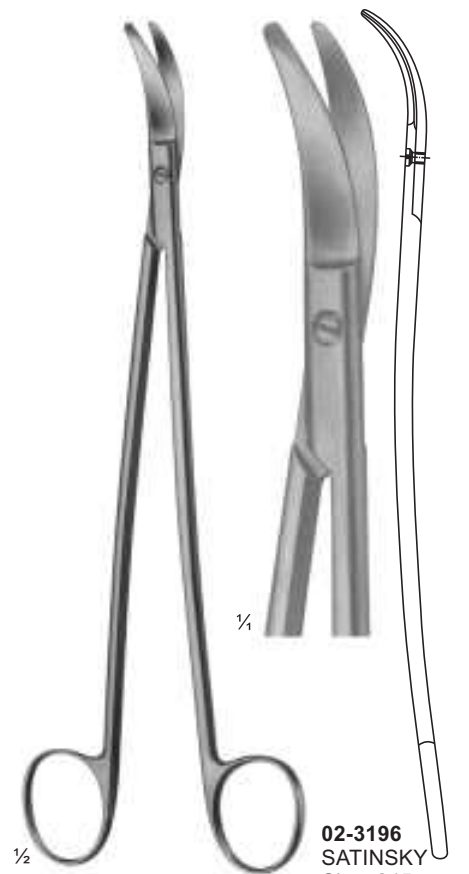

02-3196
SATINSKY
Size: 245 mm

Delicate, Nasal and Tonsil Scissors

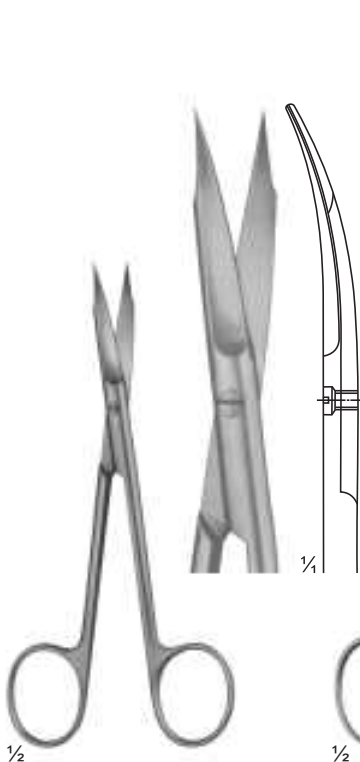

02-3197
1 Finely Toothed Blade
Size: 130 mm

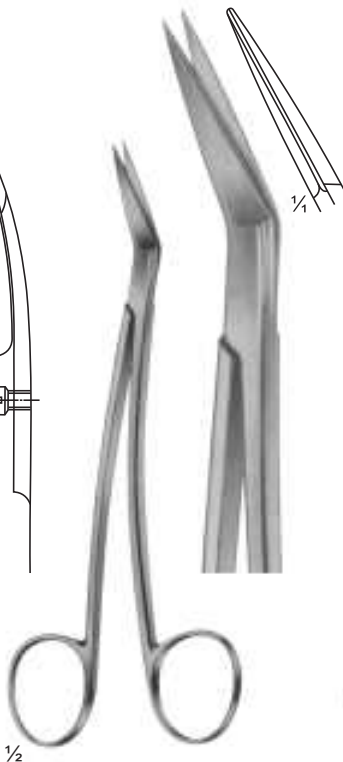

02-3198
LOCKLIN
Curved Sideways,
1 Toothed Blade
Size: 155 mm

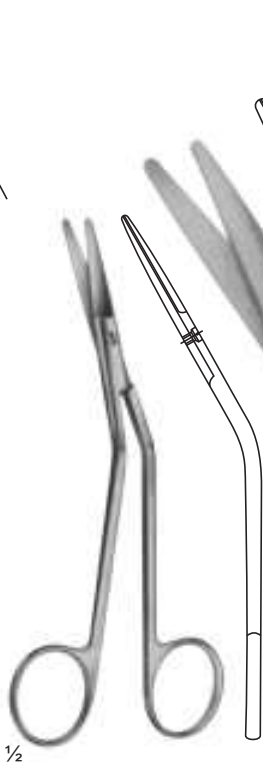

02-3199
FOMON
Blades Serrated
Size: 145 mm

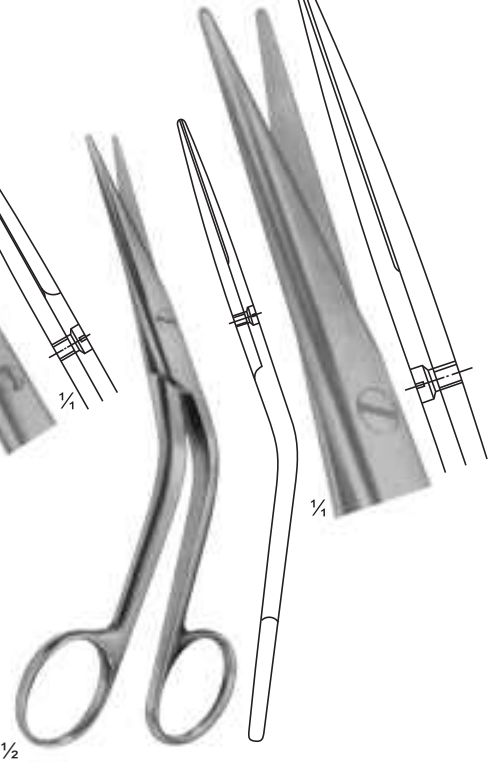

02-3200
COTTLE
Size: 165 mm

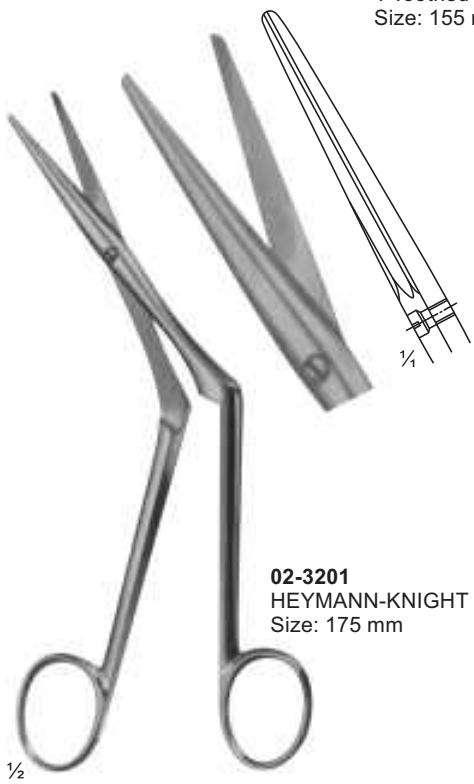

02-3201
HEYMANN-KNIGHT
Size: 175 mm

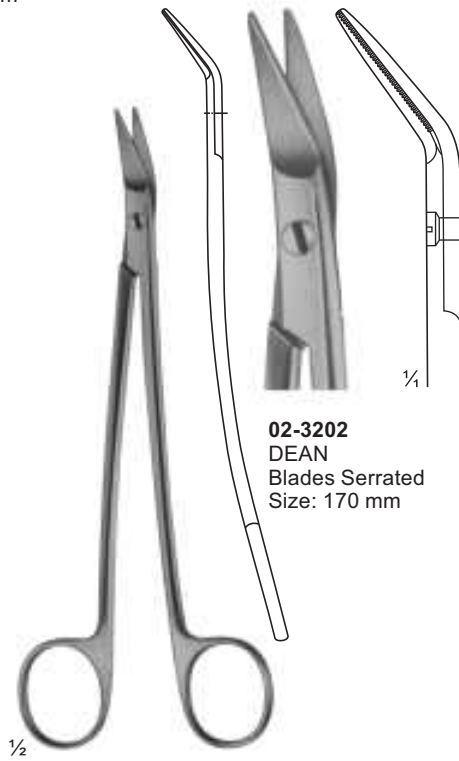

02-3202
DEAN
Blades Serrated
Size: 170 mm

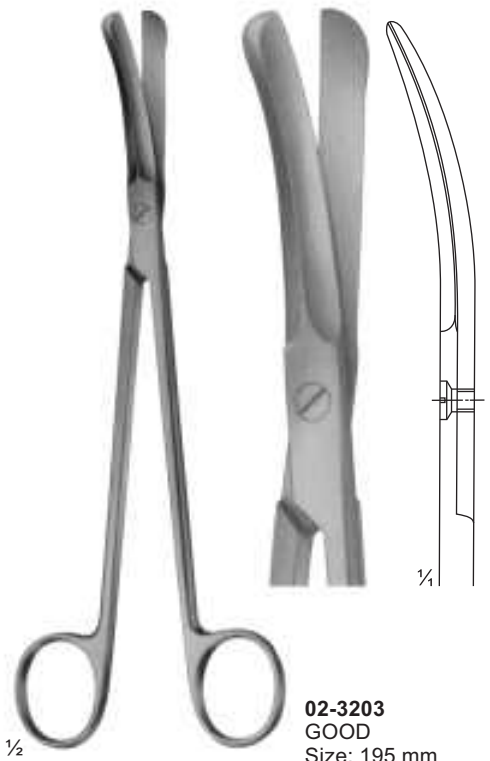

02-3203
GOOD
Size: 195 mm

Bone Shears



02-3204
KILLIAN
Size: 200 mm



02-3205 - 02-3206



02-3205
195 mm

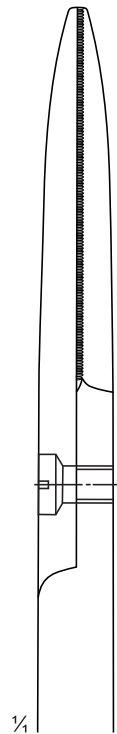

1/4



02-3206
225 mm

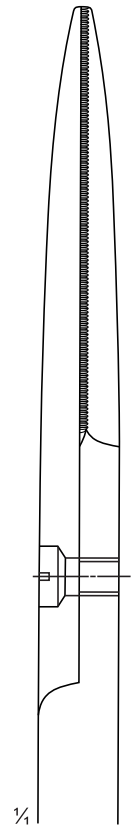

1/4

Operating and Gynaecology Scissors

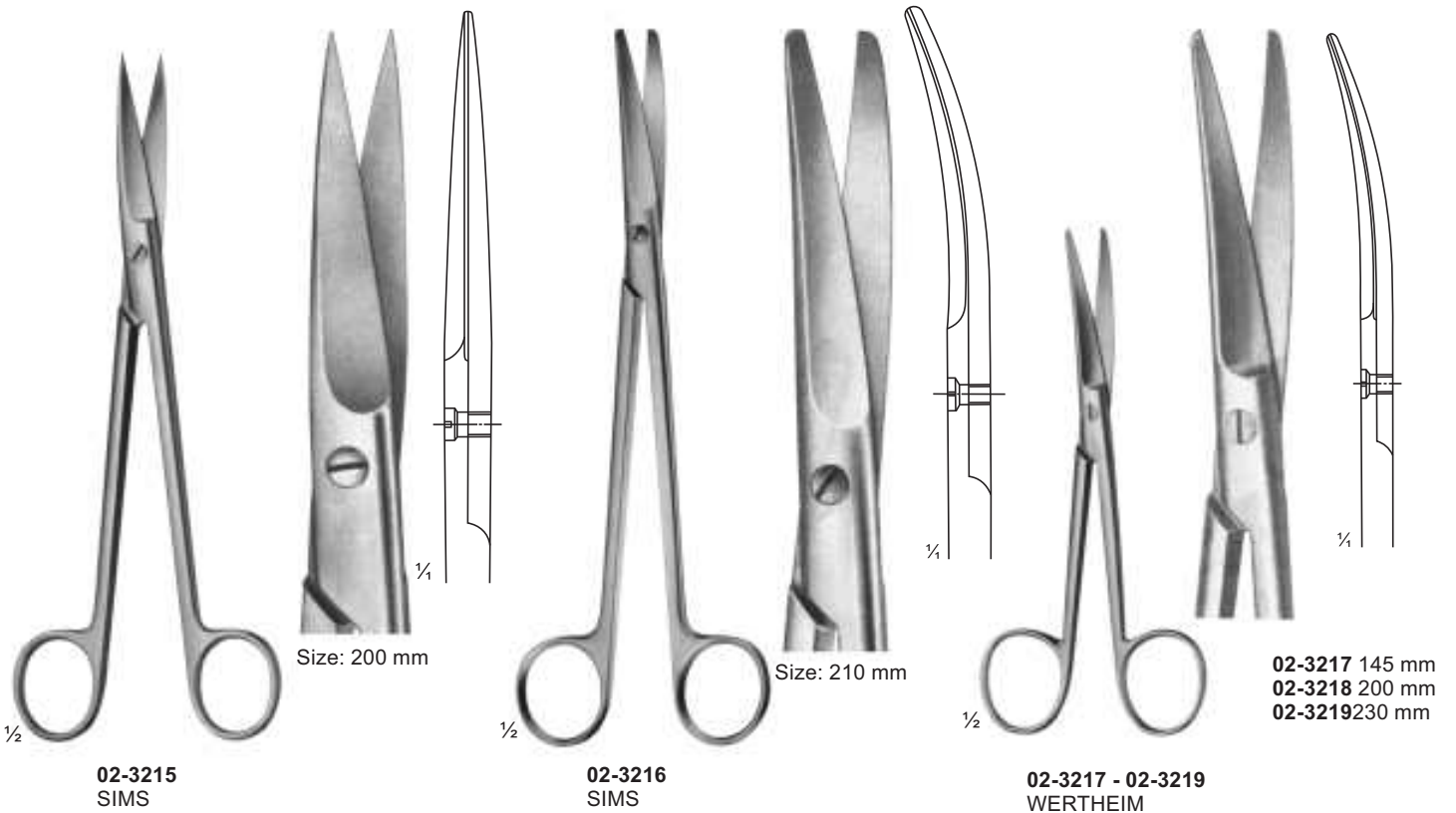
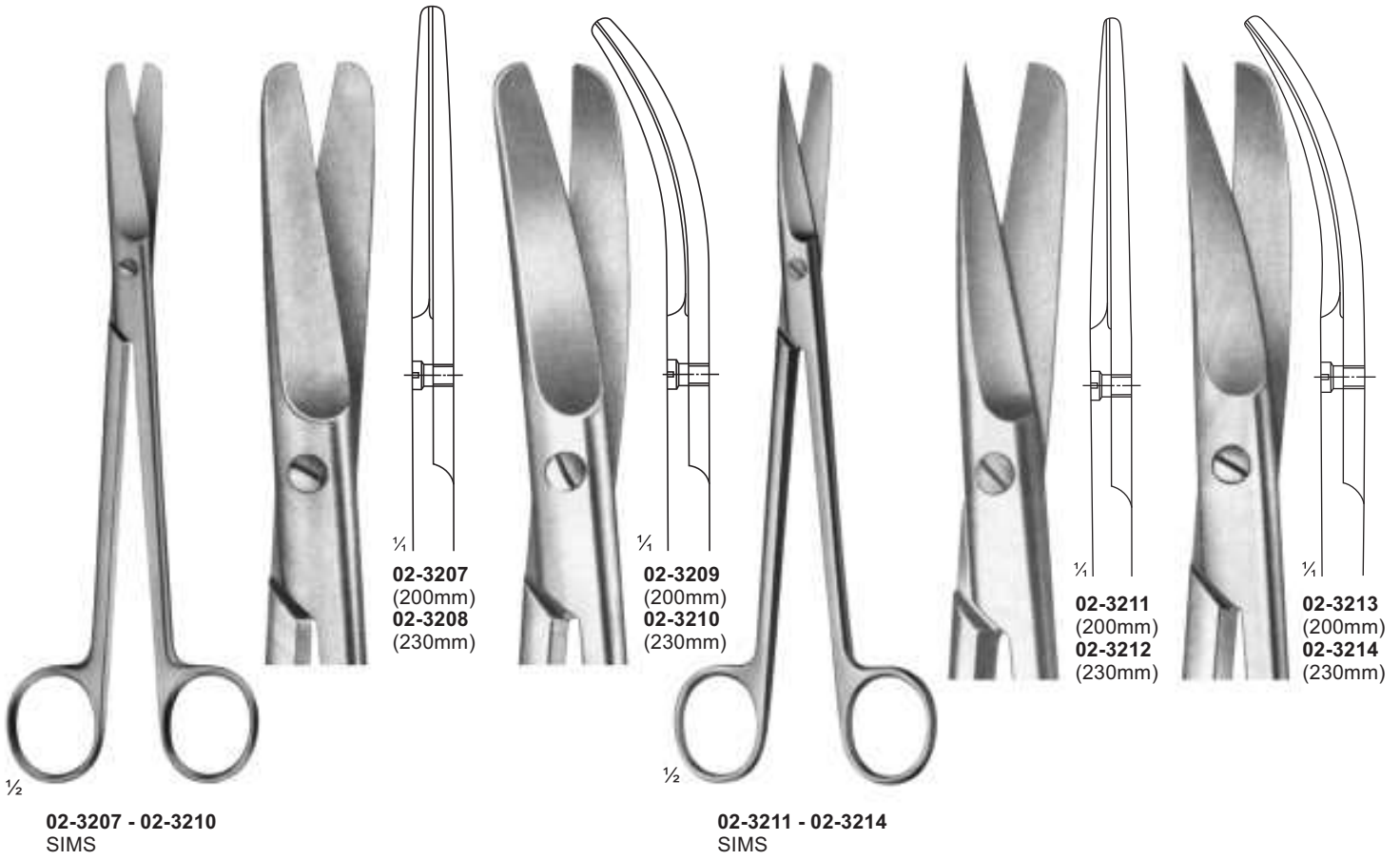



02-3220
SIEBOLD
 Uterine Scissors
 Size: 245 mm

02-3221
BOZEMANN
 Uterine Scissors
 Size: 220 mm

02-3222
SIMS-SIEBOLD
 Uterine Scissors
 Size: 250 mm

Scissors For Obstetrics



02-3223
SCHUMACHER
Umbilical Cord Scissors
Size: 155 mm



02-3224
Umbilical Cord Scissors
Size: 105 mm

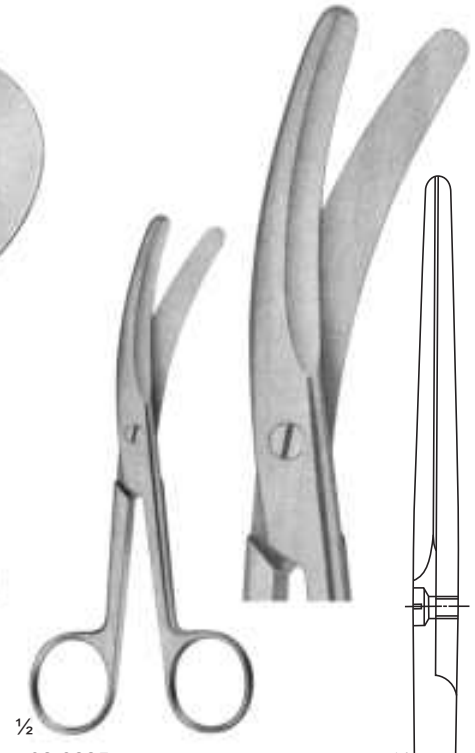

02-3225
Umbilical Cord Scissors

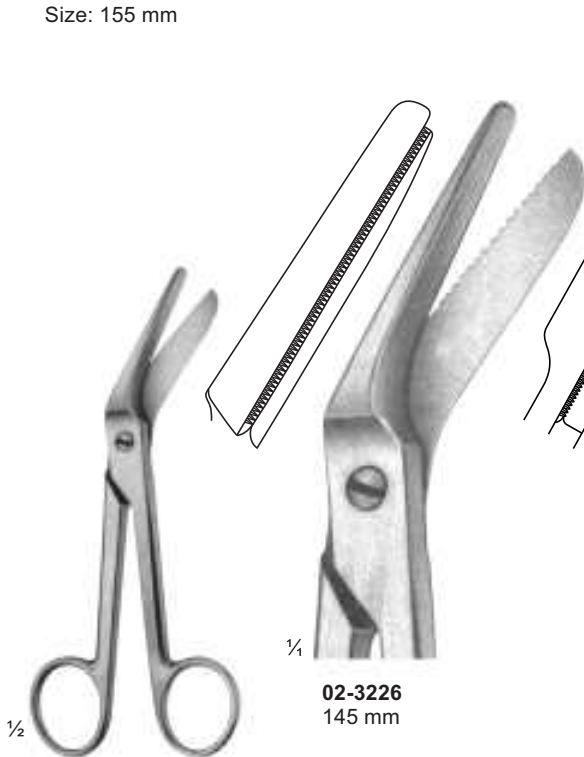
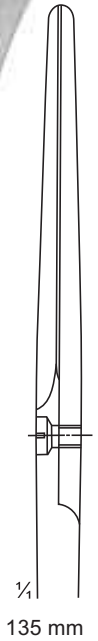

02-3226 - 02-3227
BRAUN-STADLER
Episiotomy Scissors

02-3226
145 mm

02-3227
200 mm

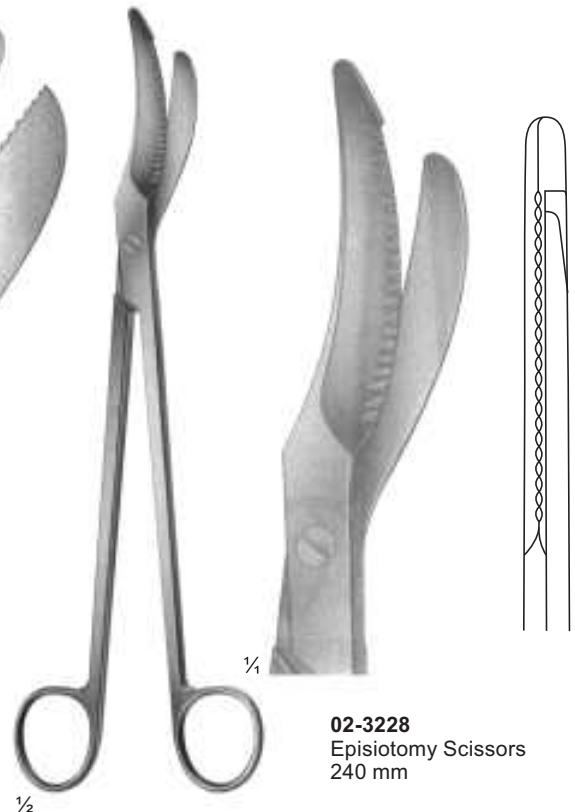

02-3228
Episiotomy Scissors
240 mm

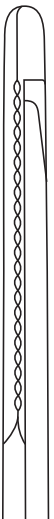

Bowel Scissors, Rectal Scissors

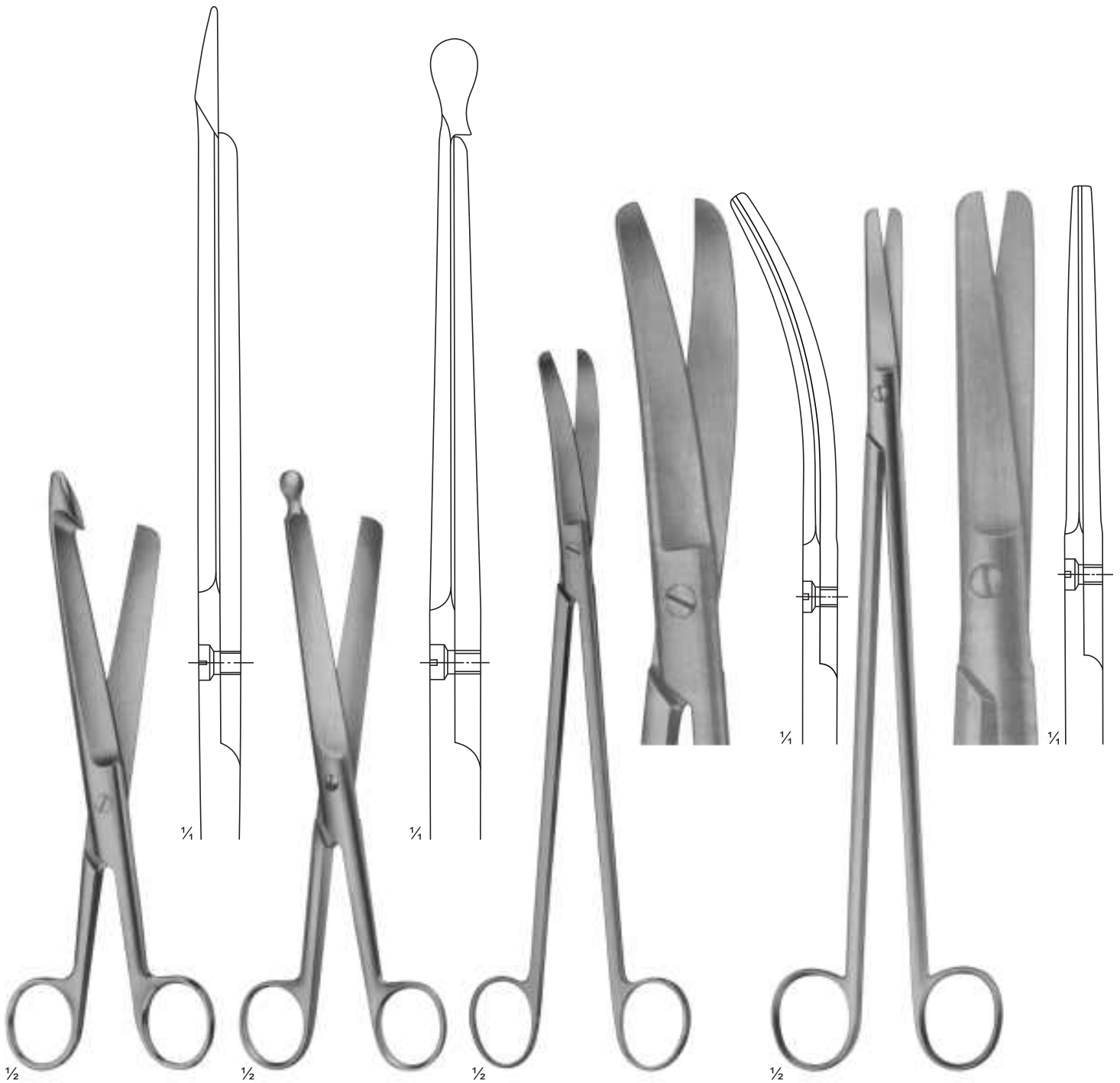

02-3229
Bowel Scissors
Size: 210 mm

02-3230
Bowel Scissors
Size: 210 mm

02-3231
LLOYD-DAVIES
(GOLIGHER'S)
Rectal Scissors
Size: 270 mm

02-3232
STELZNER
Rectal Scissors
Size: 310 mm

Ligature Scissors

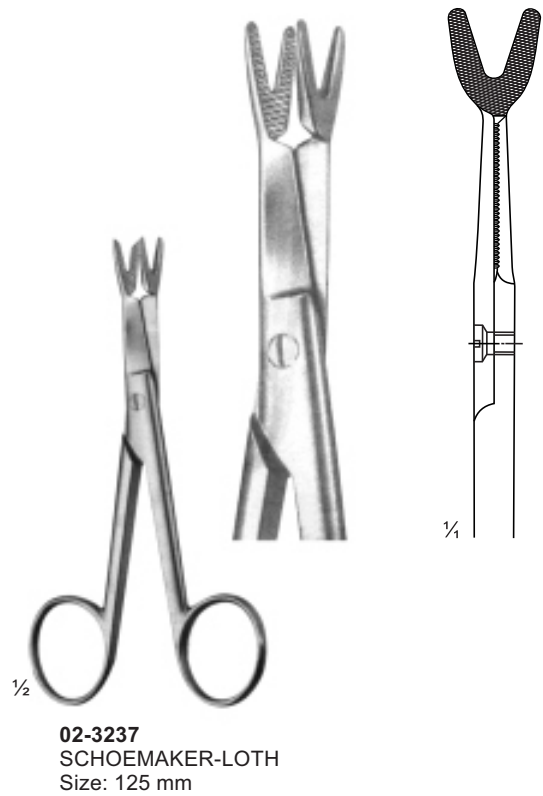
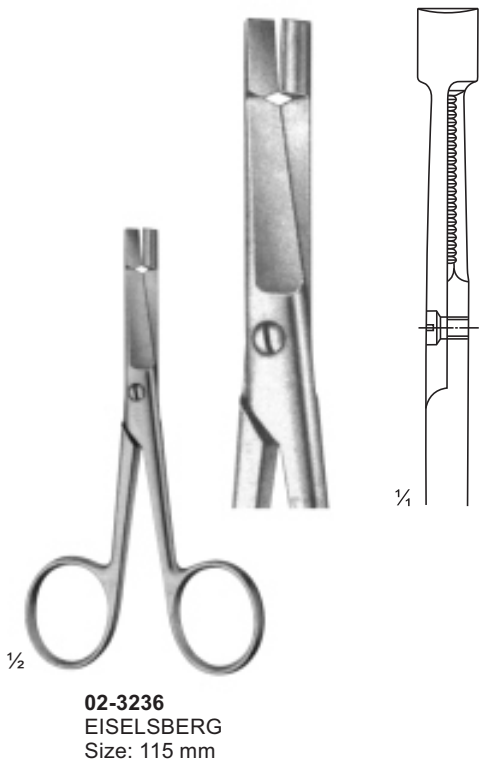
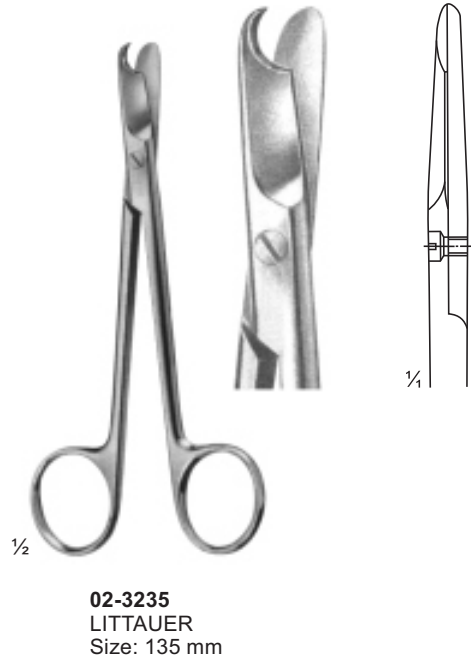
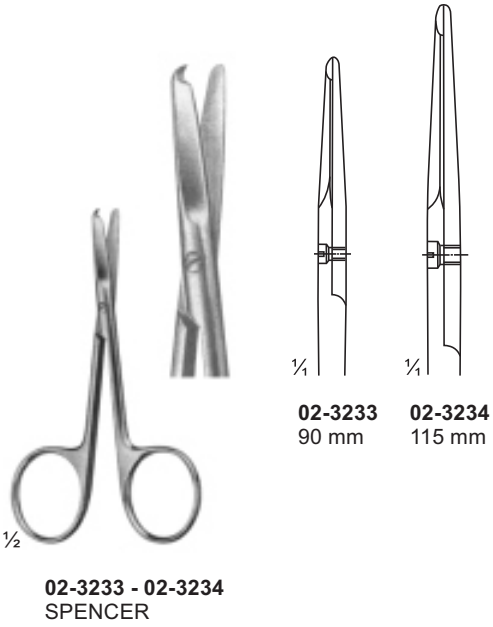

Wire and Plate Scissors



1/2

02-3238 - 02-3242
BEEBE
Size: 110 mm

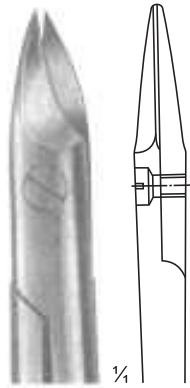

1/4

02-3238

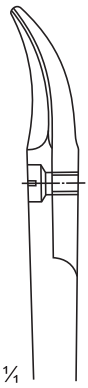

1/4

02-3239

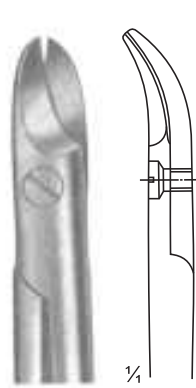

1/4

02-3240
Broad Blades

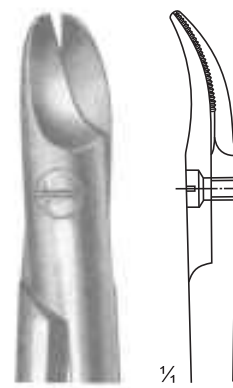

1/4

02-3241
1 Blade Serrated

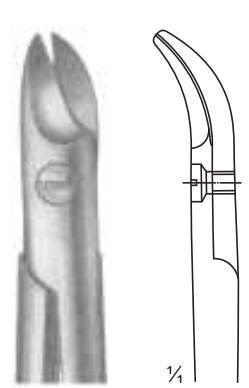

1/4

02-3242
NAUJOKS
Strongly Curved

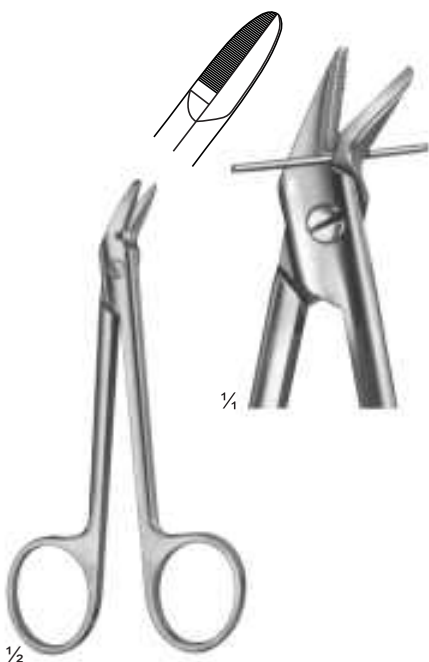

1/2

02-3243
1 Blade Serrated
Size: 120 mm

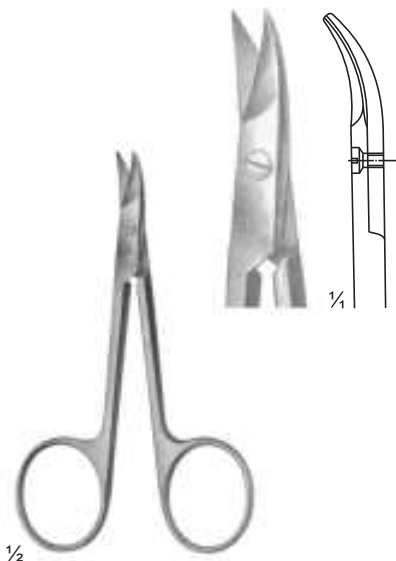

1/2

02-3244
STRACK
Size: 100 mm

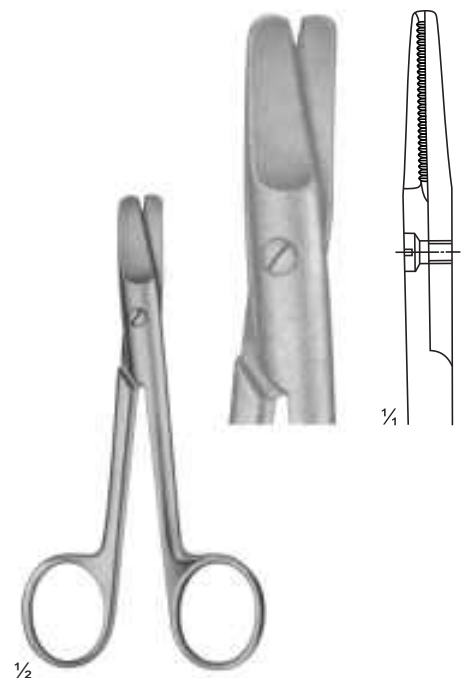

1/2

02-3245
HARVEY
blades serrated
Size: 125 mm

Nail and Bandage Scissors

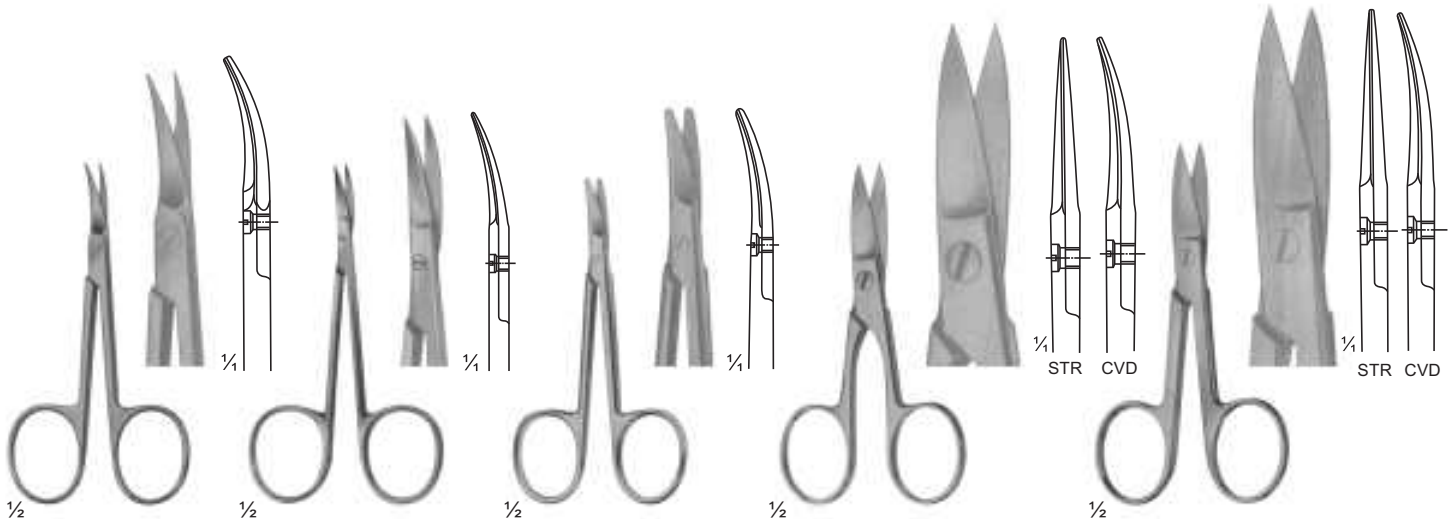

02-3246
NAIL SCISSORS
Size: 90 mm

02-3247
NAIL SCISSORS
especially fine pattern
Size: 90 mm

02-3248
BABY NAIL
SCISSORS
Size: 85 mm

02-3249 - 02-3252
NAIL SCISSORS
02-3249(90mm)straight
02-3250(90mm)curved
02-3251(100mm)straight
02-3252(110mm)curved

02-3253 - 02-3255
NAIL SCISSORS
02-3253(95mm)straight
02-3254(95mm)curved
02-3255(105mm)straight

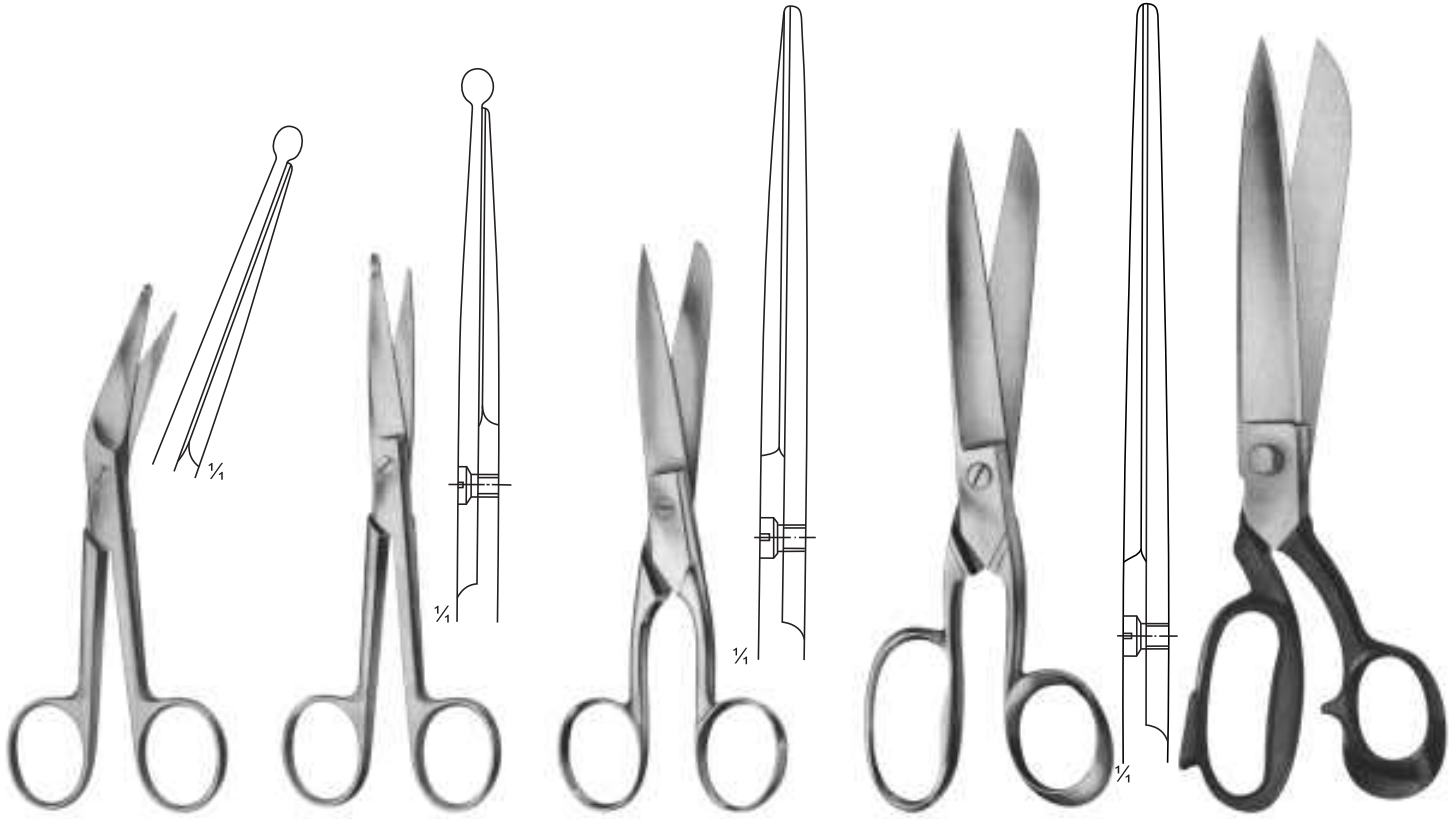

02-3256
KNOWLES
Size: 140 mm

02-3257
KNOWLES
Size: 145 mm

02-3258
Size: 150 mm

02-3259
SMITH
Size: 180 mm

02-3260
BANDAGE CUTTING
SCISSORS
Size: 310 mm

Bandage and Cloth Scissors



1/2
02-3261
 UNIVERSAL BANDAGE & CLOTH SCISSORS,
 WITH TOOTHED EDGES, AUTO CLEAVABLE up to 143 °C
 180 mm

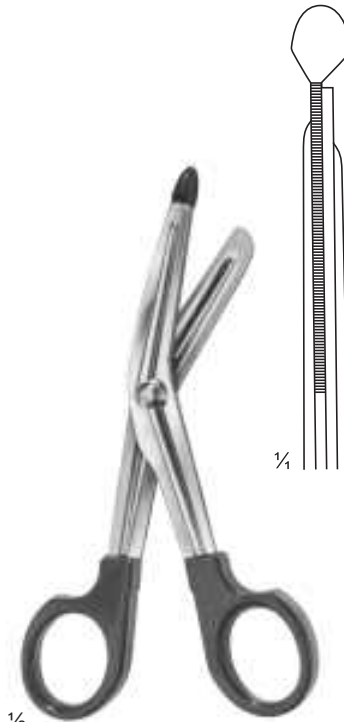

1/2
02-3262
 LISTER BANDAGE & CLOTH
 SCISSORS, WITH TOOTHED EDGES,
 AUTO CLEAVABLE up to 143 °C
 Size: 145 mm

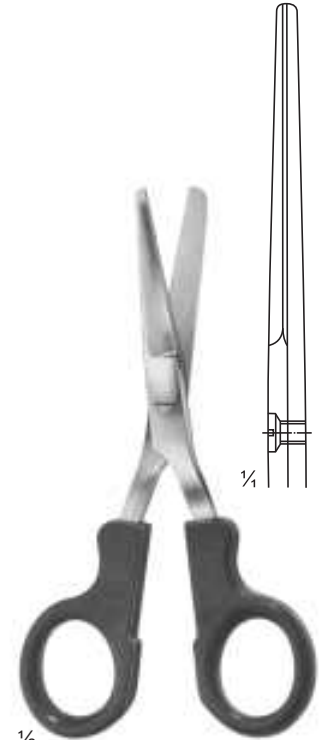

1/2
02-3263
 NURSE'S SCISSORS
 Size: 145 mm
 AUTO CLEAVABLE up to 143 °C

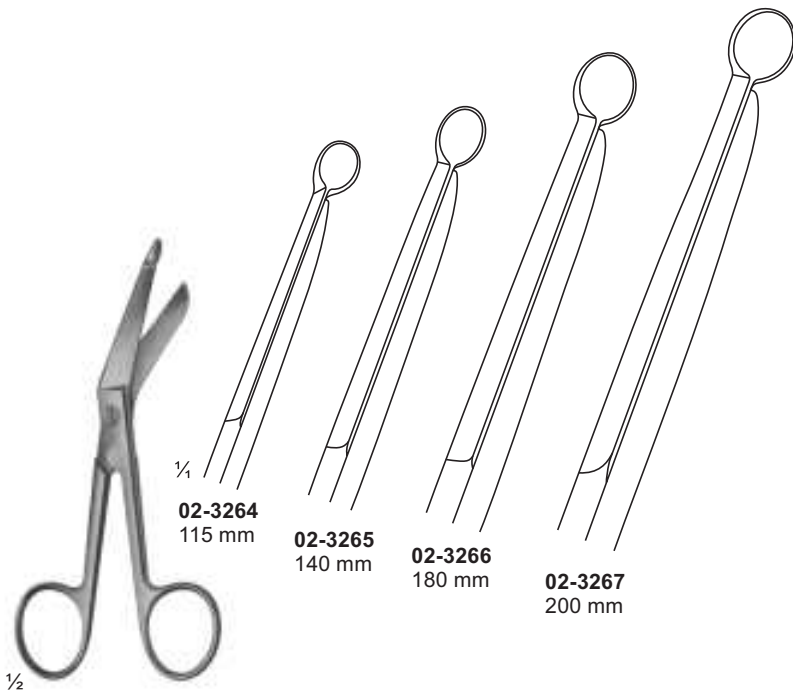

1/2
02-3264 - 02-3267
 LISTER

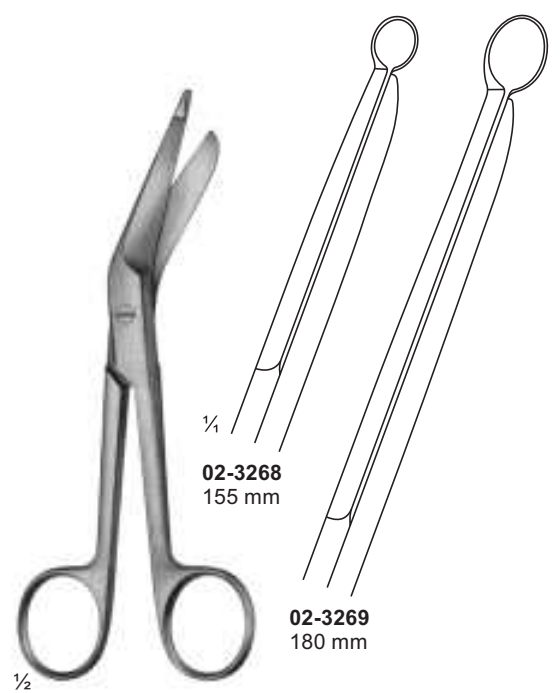

1/2
02-3268 - 02-3269
 LISTER

Bandage, Cloth and Plaster Scissors

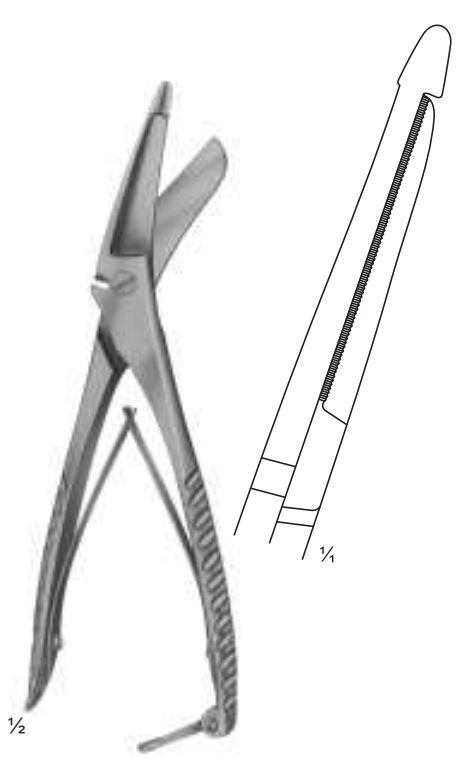

02-3270
CLOTH SCISSORS
205 mm

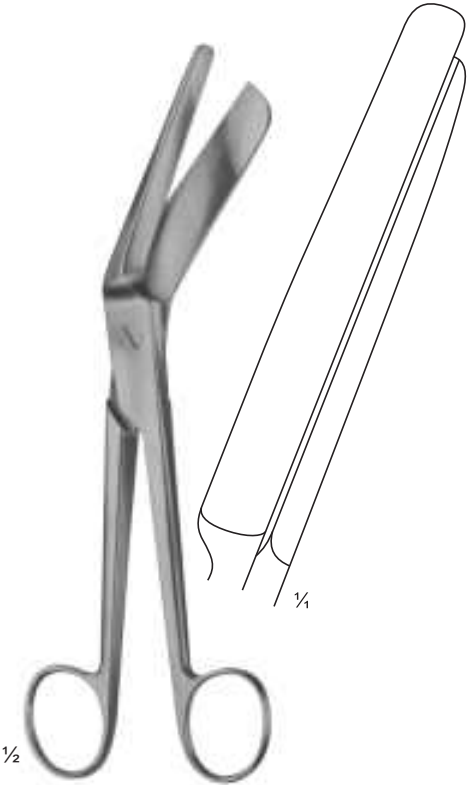

02-3271
BRAUN-STADLER
Bandage scissors
225 mm



02-3272
SEUTIN
Plaster scissors
230 mm

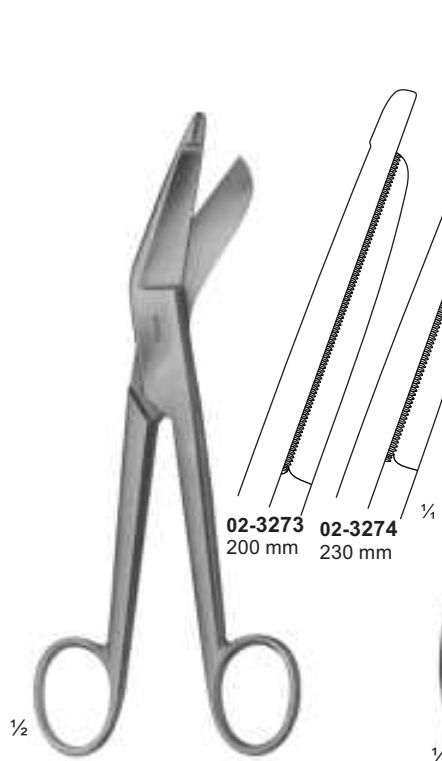

02-3273 - 02-3274
ESMARCH (Plaster scissors)

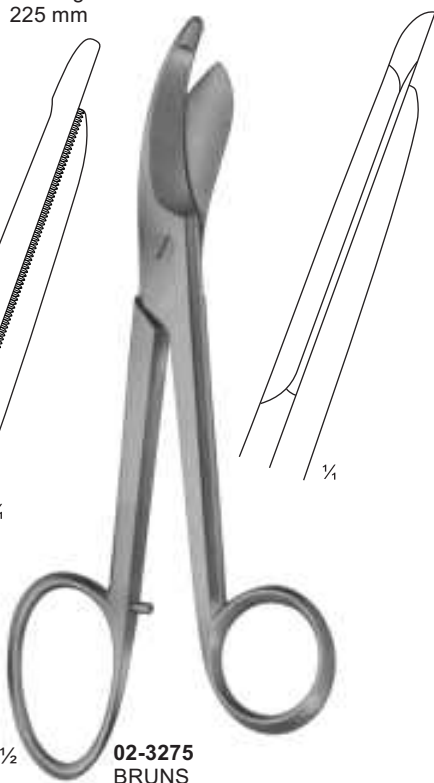

02-3275
BRUNS
Plaster scissors
235 mm

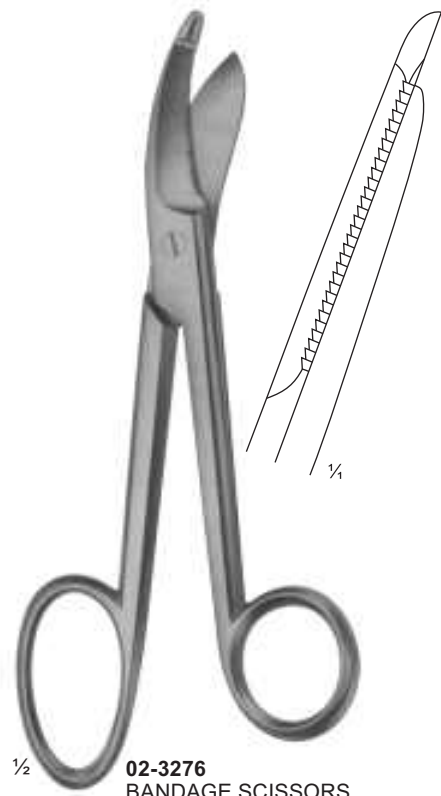

02-3276
BANDAGE SCISSORS
235 mm

Micro Forceps, Jeweler Types and Micro Suture Tying Forceps

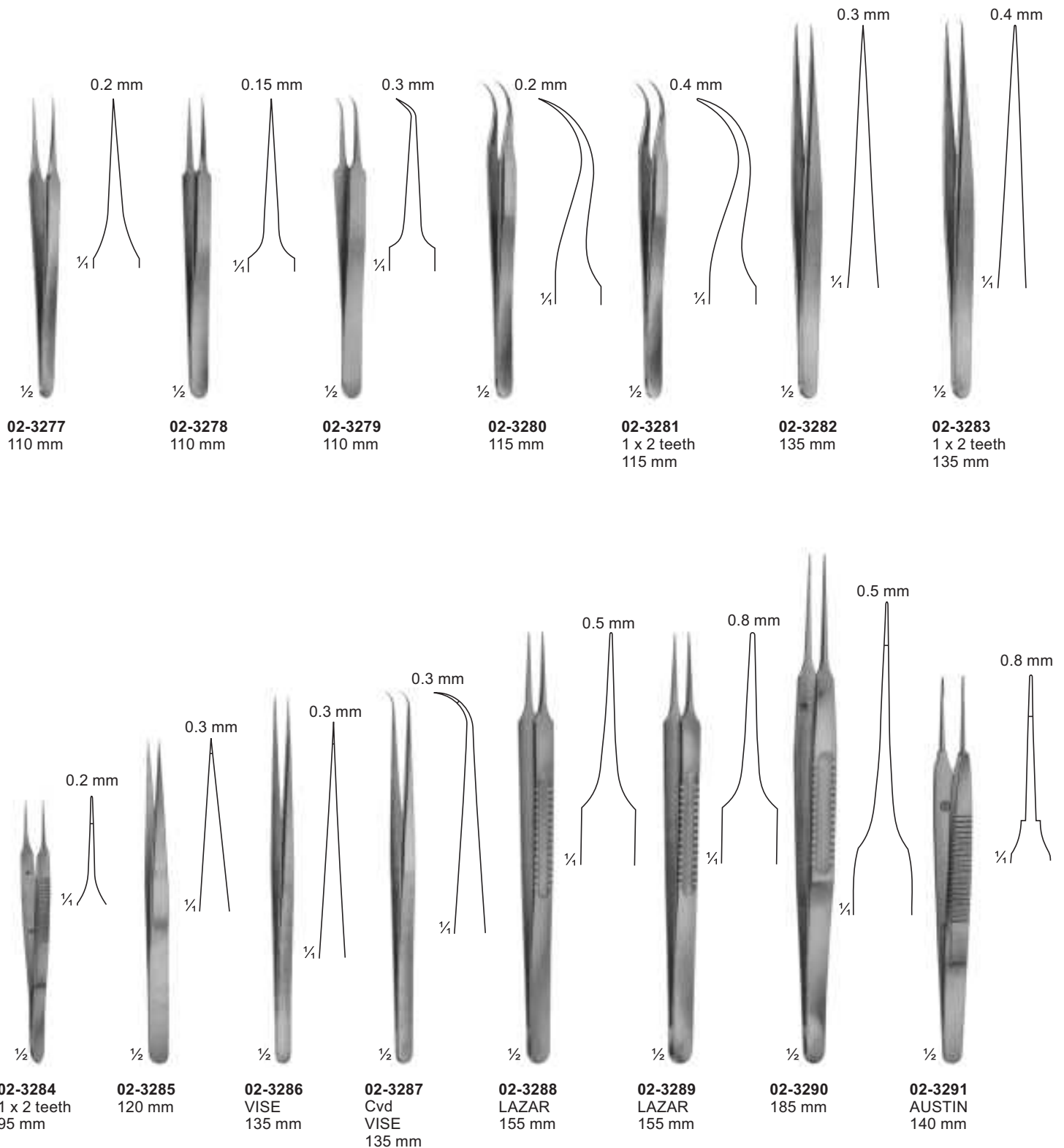

Micro Forceps, Ligature Forceps (Light Pattern) Bayonet - Shaped

0.15 mm 0.20 mm 0.30 mm 0.50 mm

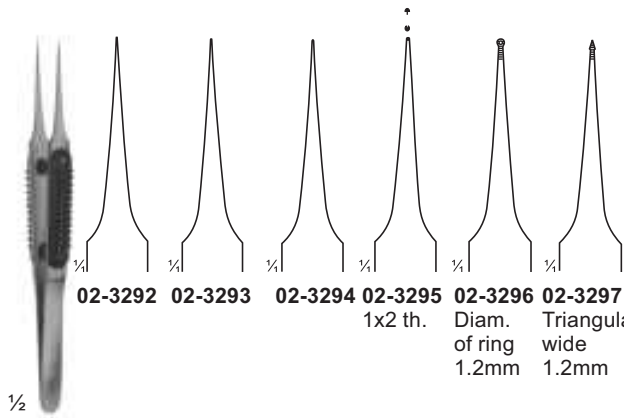

02-3292 02-3293 02-3294 02-3295 02-3296 02-3297
1x2 th. Diam. Triangular
of ring wide
1.2mm 1.2mm

1/2

02-3292 - 02-3297
MULLER
110 mm

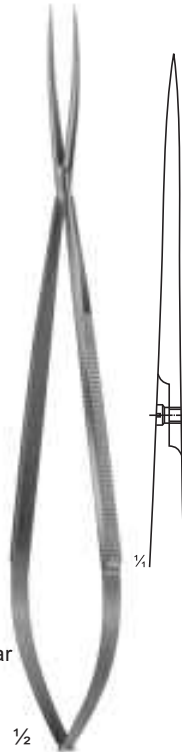

1/2

02-3298
LIGATURE
FORCEPS
220 mm

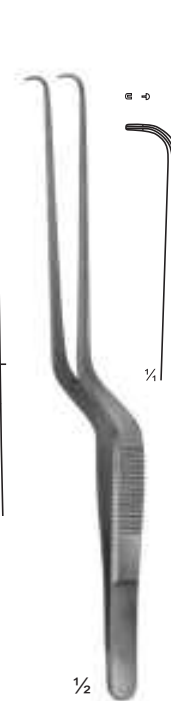

1/2

02-3299
YASARGIL
Ligature forceps
185 mm

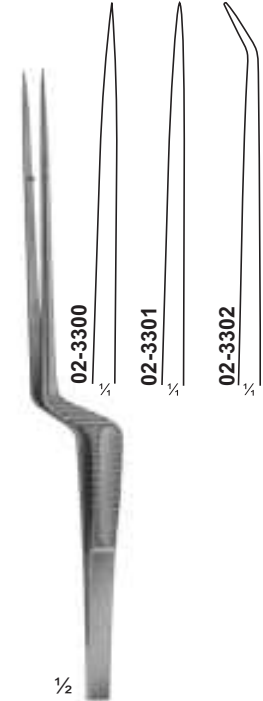

1/2

02-3300 - 02-3302
MICRO FORCEPS
Ligature pattern
185 mm

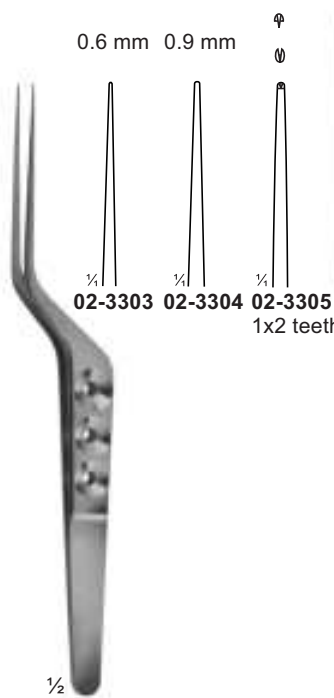

0.6 mm 0.9 mm
02-3303 02-3304 02-3305
1x2 teeth

1/2

02-3303 - 03-3305
YASARGIL
180 mm



0.6 mm 0.9 mm
02-3306 02-3307

1/2

02-3306 - 02-3307
YASARGIL
200 mm



0.6 mm

02-3308

1/2

02-3308 - 03-3309
YASARGIL
220 mm

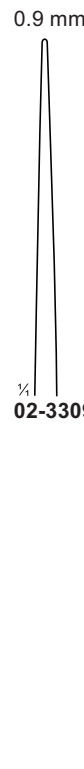

0.9 mm

02-3309

1/2

02-3310 - 02-3311
YASARGIL
240 mm

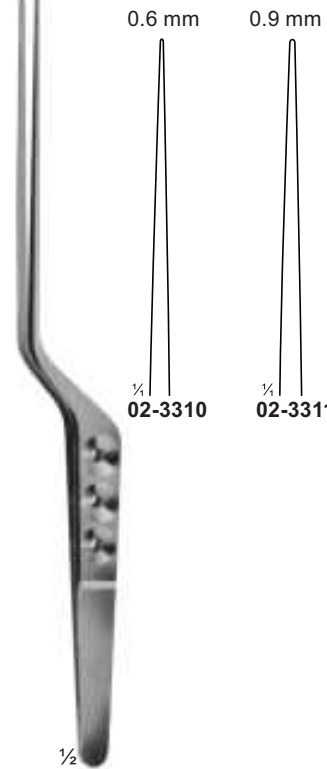

0.6 mm

0.9 mm

02-3310

02-3311

1/2

Forceps for Grasping Tissue, Tumors, Bayonet Shaped

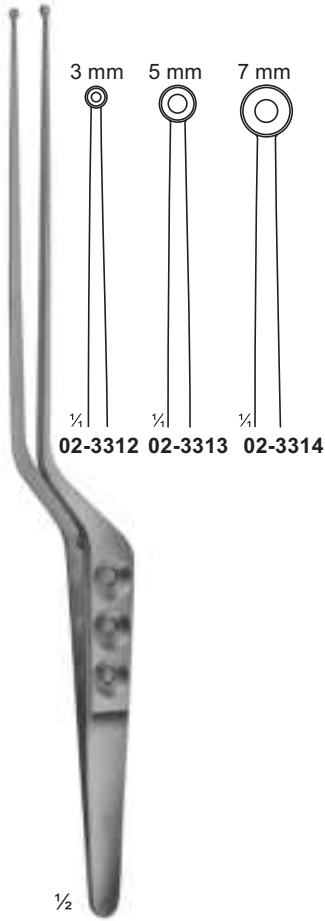

02-3312 - 02-3314
YASARGIL-SAMII
Jaws Spoon-Shaped
240 mm

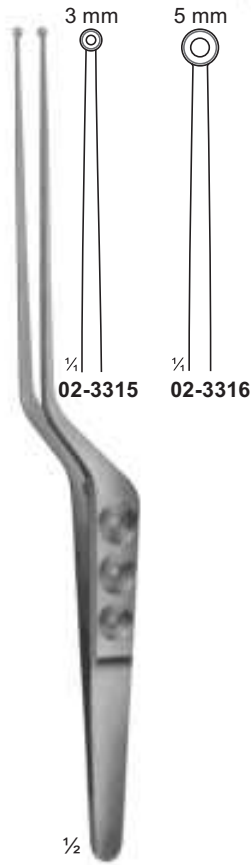

02-3315 - 02-3316
YASARGIL
Jaws Spoon-Shaped
220 mm

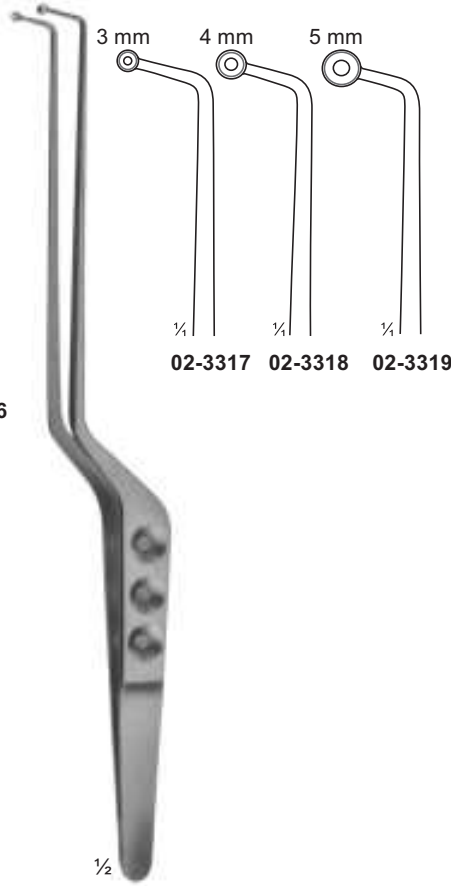

02-3317 - 02-3319
SAMII
Jaws Spoon-Shaped
230 mm

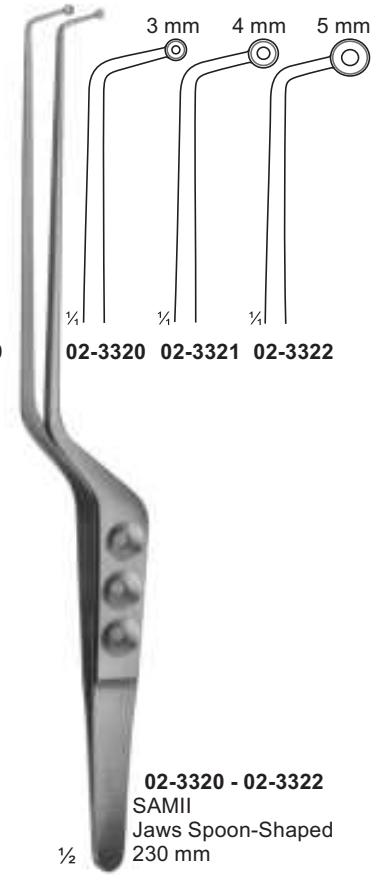

02-3320 - 02-3322
SAMII
Jaws Spoon-Shaped
230 mm

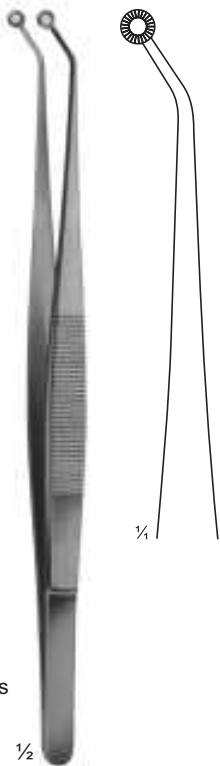

02-3323
HUNT
Tumor-and
Vessel Forceps
200 mm



02-3324
HUNT
Tumor-and
Vessel Forceps
200 mm



02-3325
YASARGIL
Tumor-and
Vessel Forceps
200 mm

Delicate Dissecting, Microscopic, Sterilizing Forceps

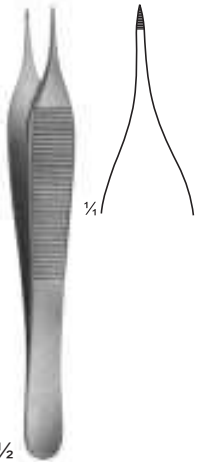

1/2
02-3326
THORPE
Corneal forceps
120 mm

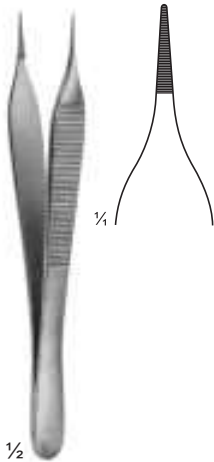

1/2
02-3327
MICRO-ADSON
120 mm

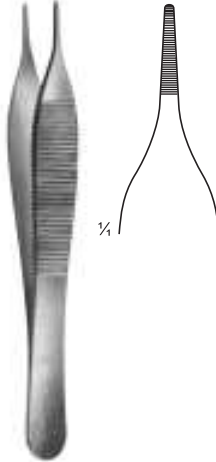

1/4
02-3328
ADSON
120 mm

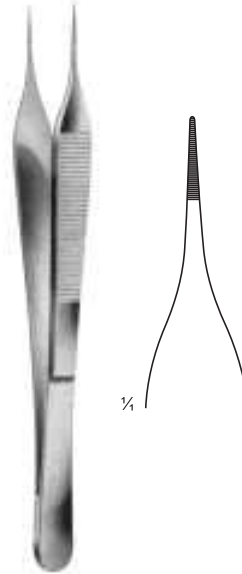

1/4
02-3329
MICRO-ADSON
150 mm



1/4
02-3330 - 02-3332
100 mm



02-3330



02-3331



02-3332

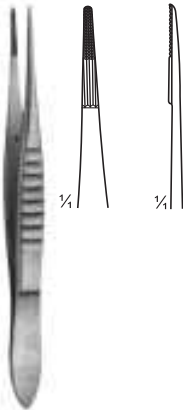

1/4
02-3333
BONACCOLTO
110 mm

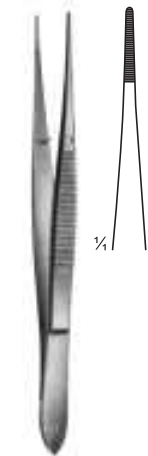

1/4
02-3334
115 mm



1/4
02-3335 - 02-3344

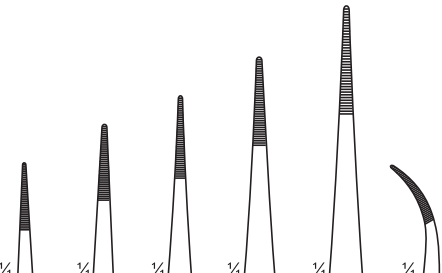

1/4
02-3335
90 mm

1/4
02-3336
105 mm

1/4
02-3337
115 mm

1/4
02-3338
130 mm

1/4
02-3339
145 mm

1/4
02-3340
90 mm



1/4
02-3341
105 mm



1/4
02-3342
115 mm



1/4
02-3343
130 mm



1/4
02-3344
145 mm



1/4
02-3345
100 mm

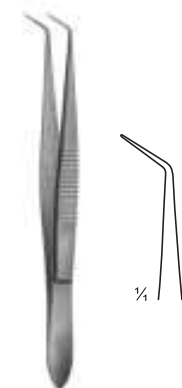

1/4
02-3346
100 mm



1/4
02-3347
100 mm



1/4
02-3348
KUHNE
Cover glass forceps
105 mm



02-3349
160 mm

Delicate Dissecting Forceps

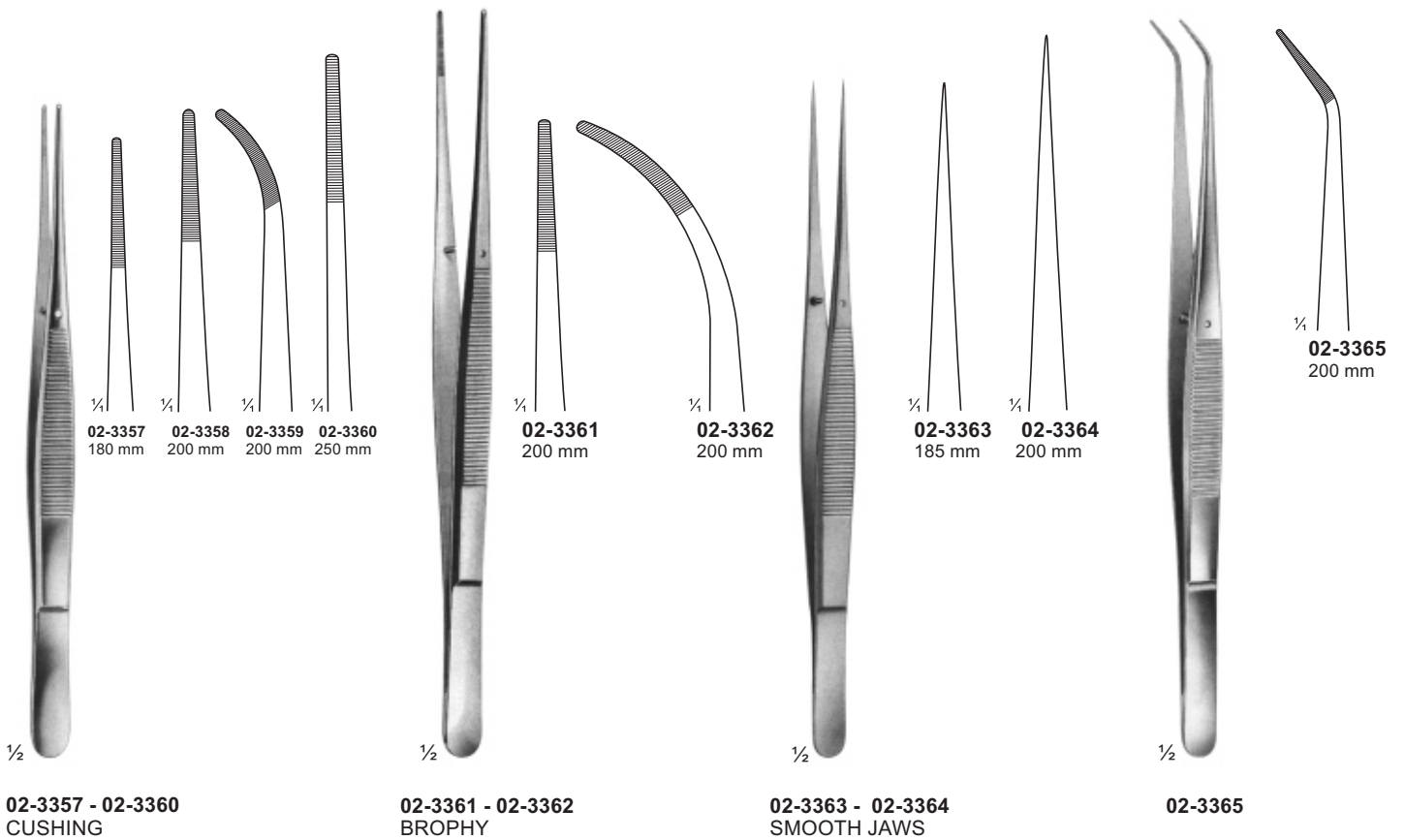
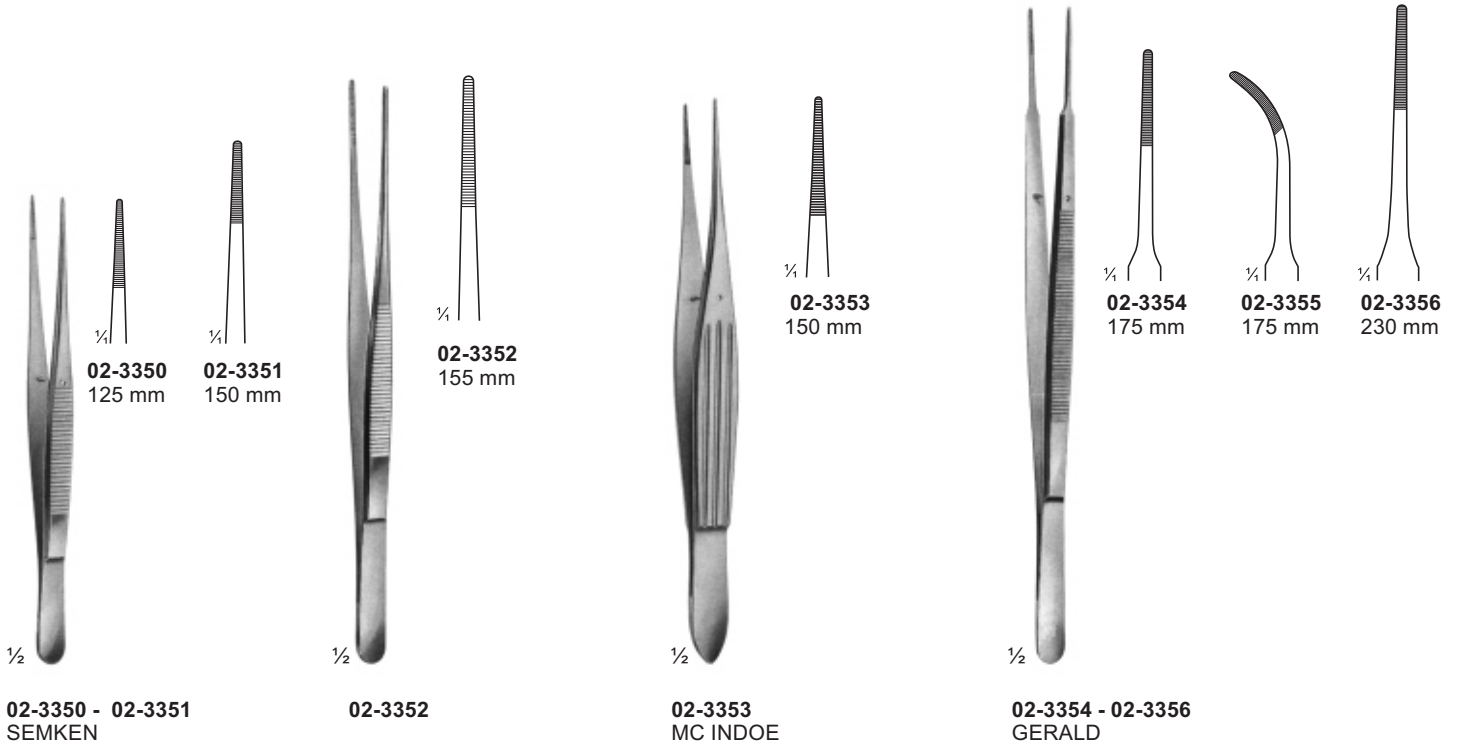

Dissecting Forceps



1/2

1/4	1/4	1/4	1/4	1/4	1/4	1/4	1/4
02-3366 115 mm	02-3367 130 mm	02-3368 145 mm	02-3369 160 mm	02-3370 180 mm	02-3371 200 mm	02-3372 250 mm	02-3373 300 mm

02-3366 - 03-3373
STANDARD



1/2

1/4	1/4	1/4	1/4	1/4
02-3374 115 mm	02-3375 130 mm	02-3376 145 mm	02-3377 160 mm	02-3378 305 mm

02-3374 - 02-3378
MEDIUM



1/2

1/4	1/4
02-3379 130 mm	02-3380 145 mm

02-3379 - 02-3380
MEDIUM

Dissecting Forceps



02-3381
125 mm



02-3382
155 mm



02-3383
130 mm



02-3384
150 mm



02-3385
170 mm

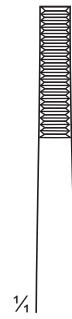

02-3386
200 mm

02-3381 - 02-3382

02-3383 - 02-3386
Swedish pattern



02-3387
OCHSNER
Ligature forceps
145mm



02-3388
FRICKE
Artery forceps
130mm

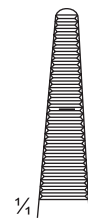

03-3389
BONNEY
175mm

Ultra-Light Forceps ATRAUMATA

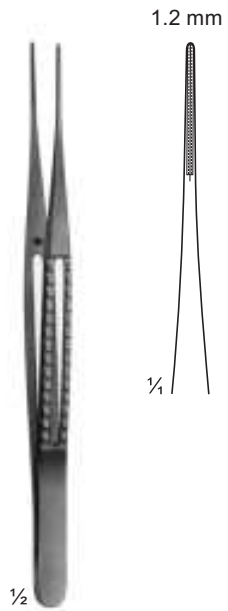

02-3390
150 mm

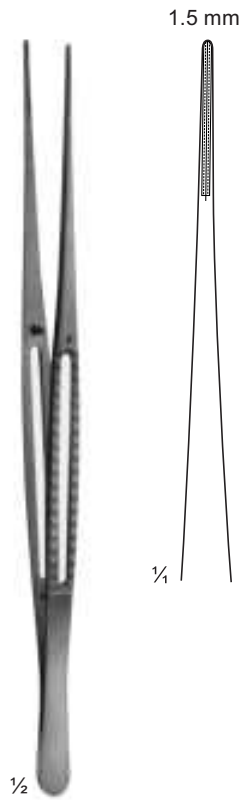

02-3391
200 mm

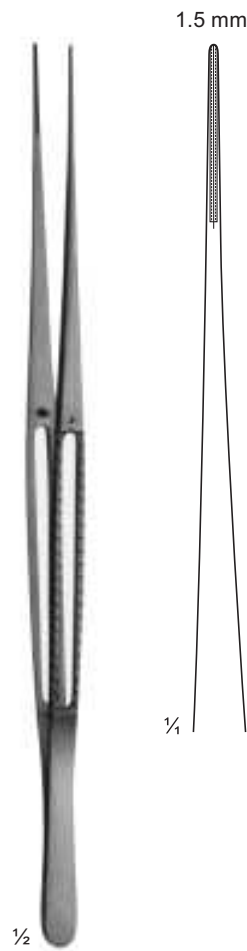

02-3392
240 mm

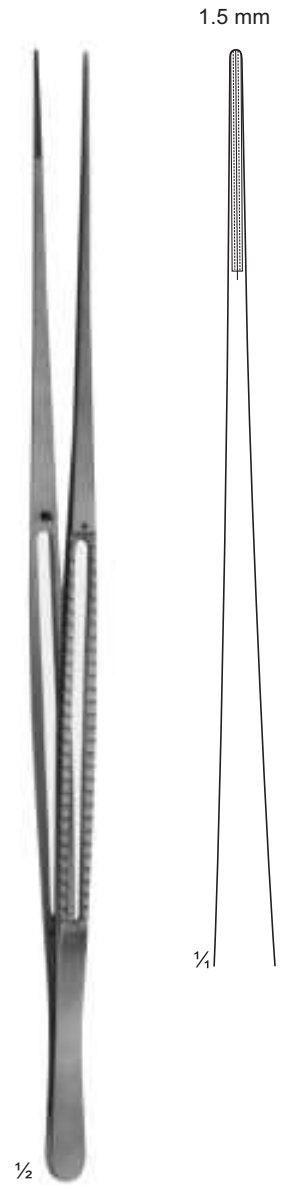

02-3393
300 mm

Forceps ATRAUMATA

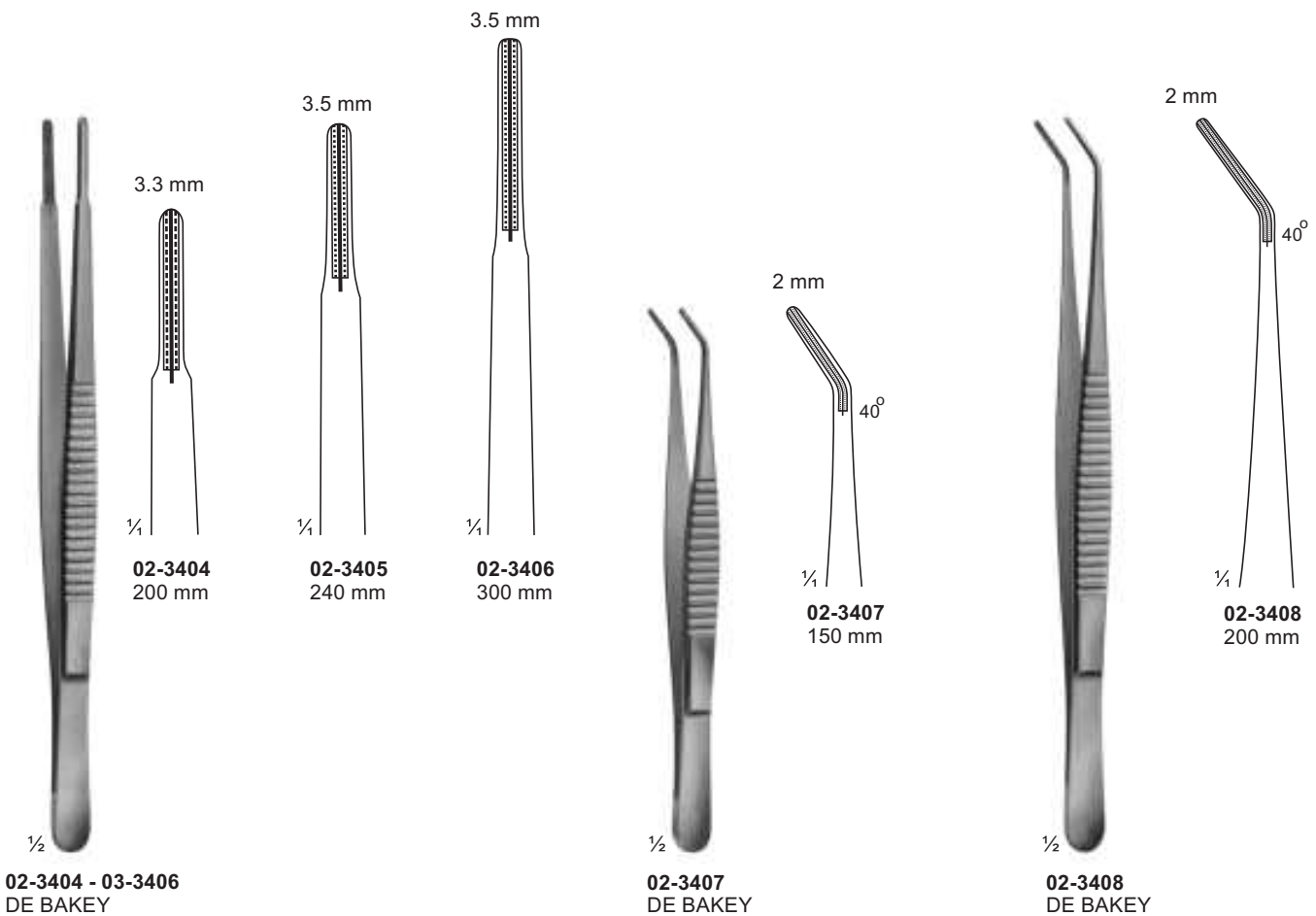
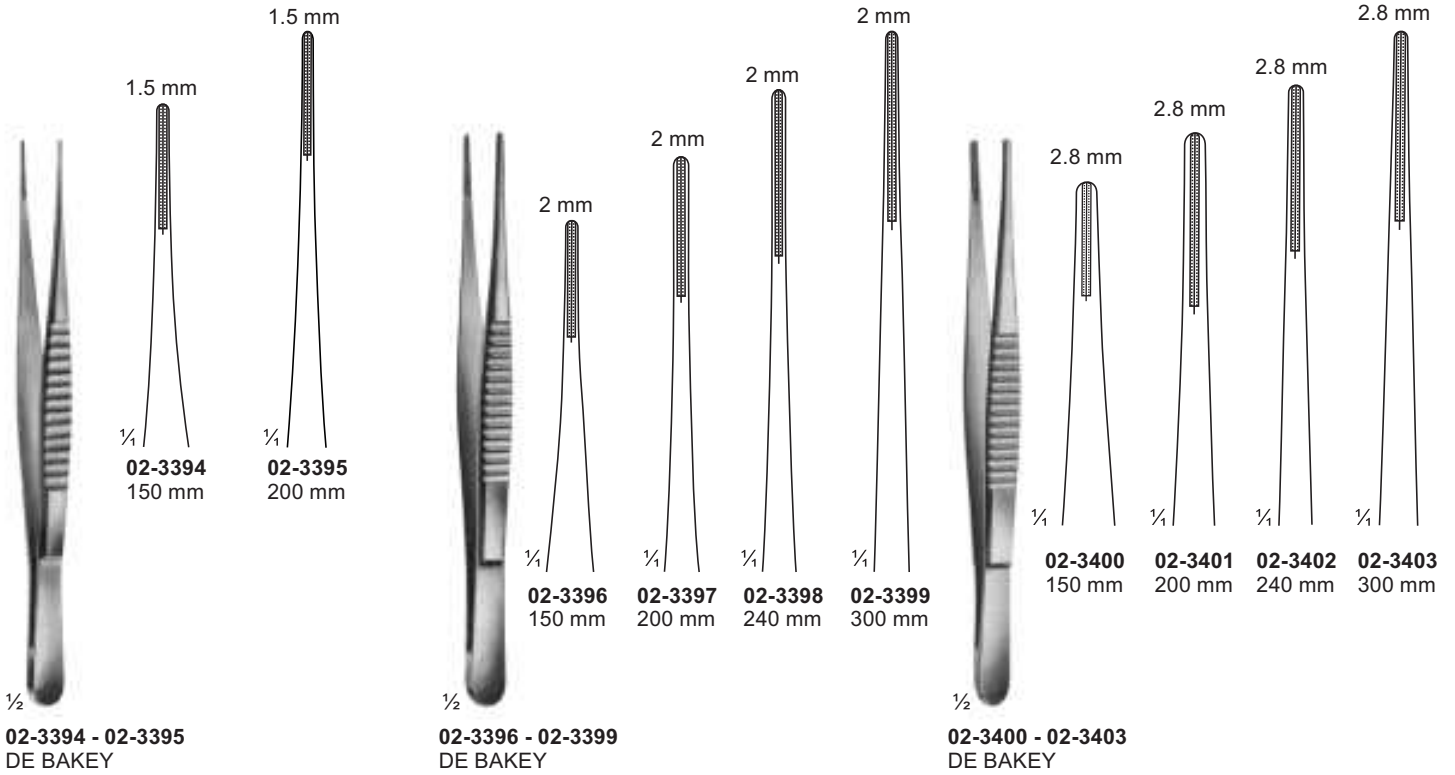

Forceps, Bayonet - Shaped, Angular

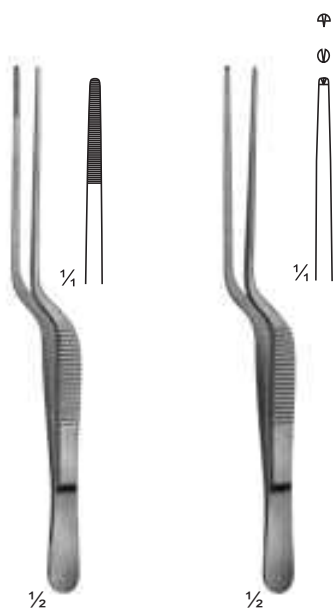

02-3409
LUCAE
140 mm

02-3410
LUCAE
1x2 teeth
140 mm



02-3411
COTTLE
Forceps with
jaws toothed
and serrated
140 mm



02-3412
JANSEN
160 mm

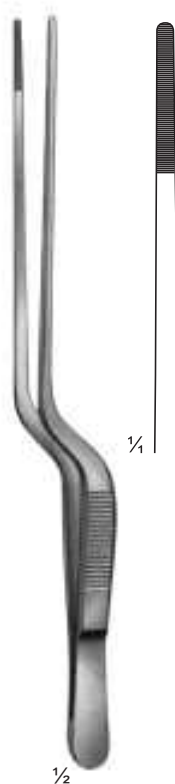

02-3413
GRUENWALD
200 mm



02-3414
1x2 teeth
200 mm

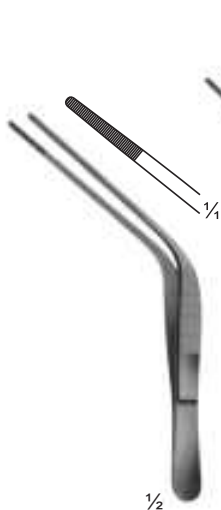

02-3415
TROELTSCH
100 mm

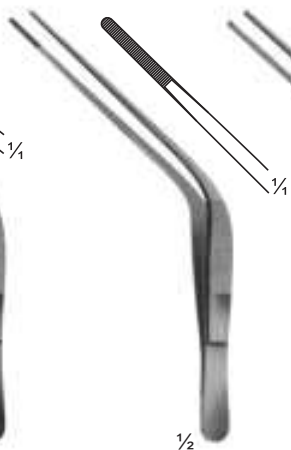

02-3416
TROELTSCH
115 mm

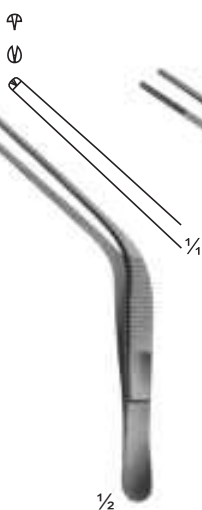

02-3417
TROELTSCH
1X2 teeth
115 mm

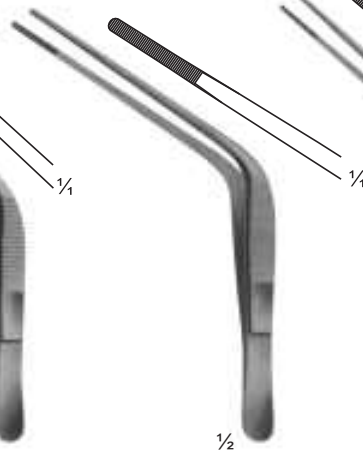

02-3418
WILDE
115 mm

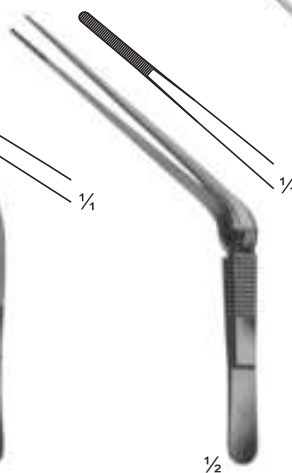

02-3419
TROELTSCH
Cross action
120 mm

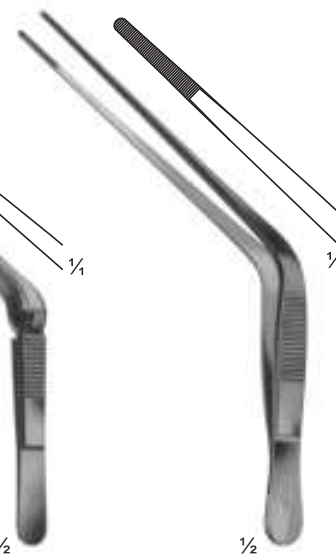

02-3420
TROELTSCH
140 mm

Delicate Tissue Forceps

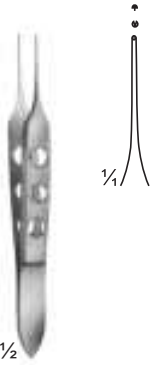

02-3421
BISHOP-HARMON
85 mm

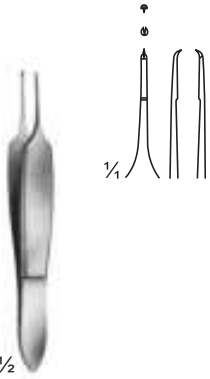

02-3422
ST.MARTIN
80 mm

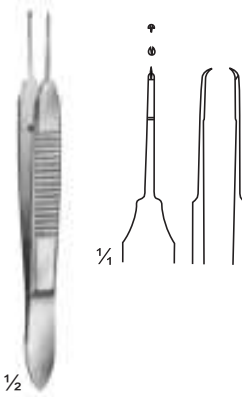

02-3423
CASTROVIEJO
teeth 0.9 mm
100 mm

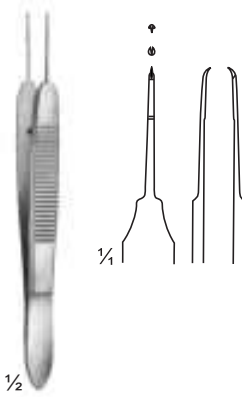

02-3424
CASTROVIEJO
teeth 0.5 mm
100 mm

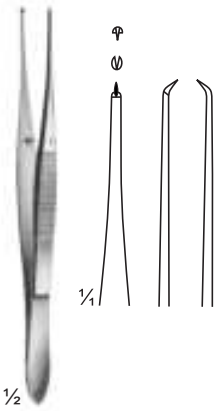

02-3425
ELSCHING
110 mm

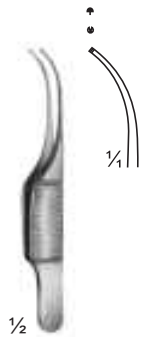

02-3426
GILL
75 mm

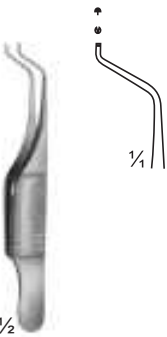

02-3427
GILL - HESS
75 mm

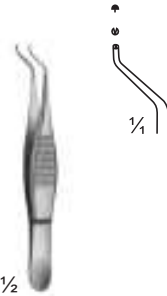

02-3428
HESS
70 mm

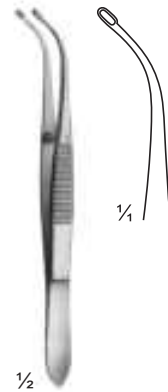

02-3429
ARRUGA
100 mm

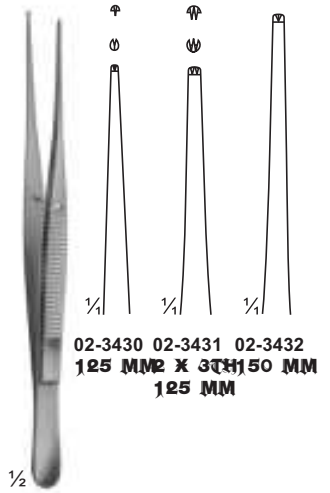

02-3430 02-3431 02-3432
125 MM X 31150 MM
125 MM

02-3430 - 02-3432
SEMKEN

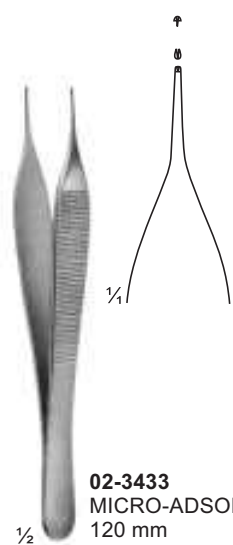

02-3433
MICRO-ADSON
120 mm

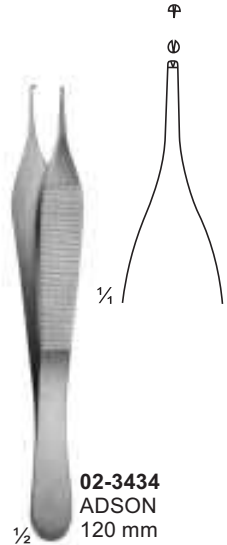

02-3434
ADSON
120 mm

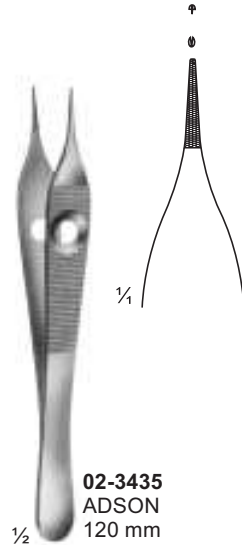

02-3435
ADSON
120 mm

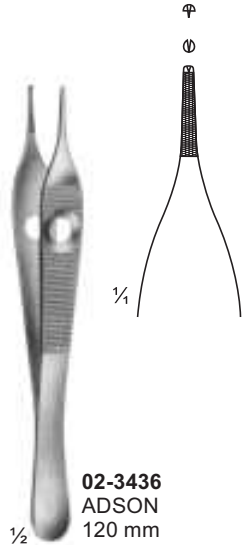

02-3436
ADSON
120 mm

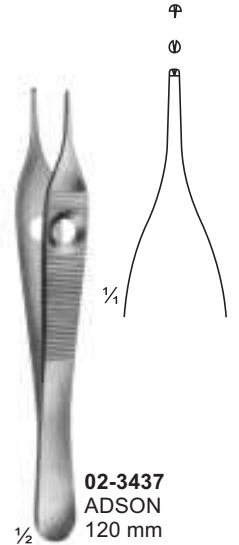

02-3437
ADSON
120 mm

Tissue Forceps

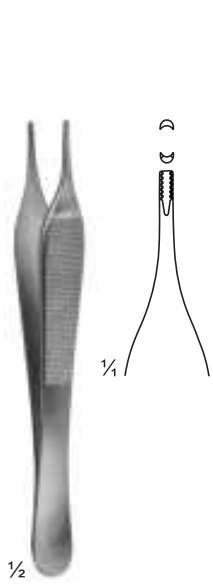

02-3438
ADSON - BROWN
Non-traumatic
120 mm

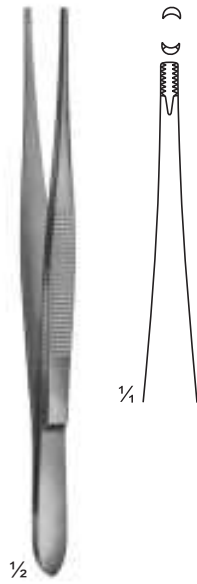

02-3439
BROWN
150 mm

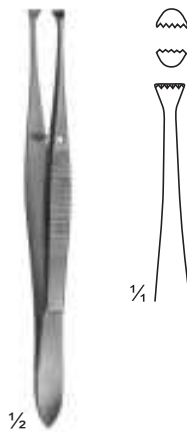

02-3440
GRAEFE
110 mm

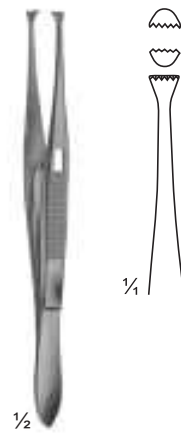

02-3441
GRAEFE
With Catch
110 mm

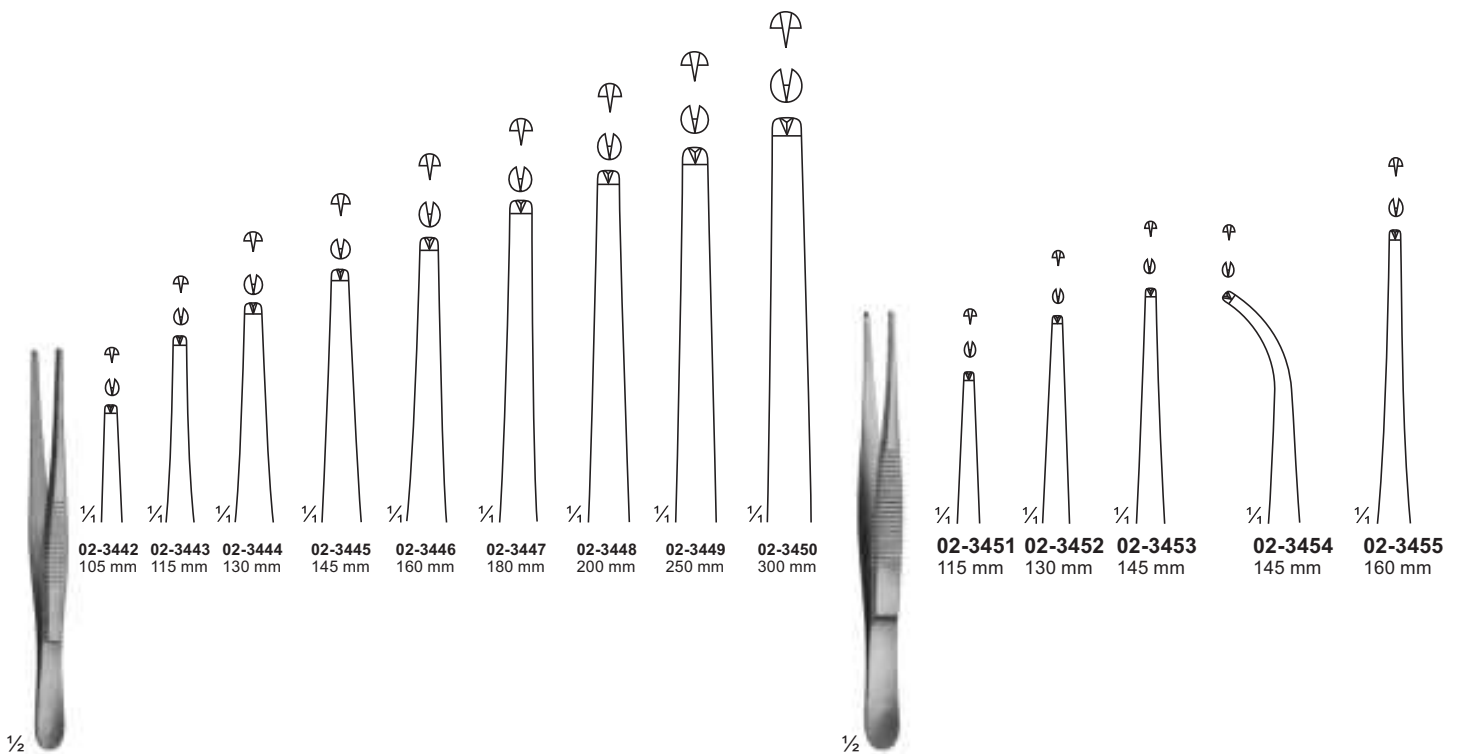

02-3442 - 02-3450
STANDARD

02-3451 - 02-3455
Medium

Tissue Forceps

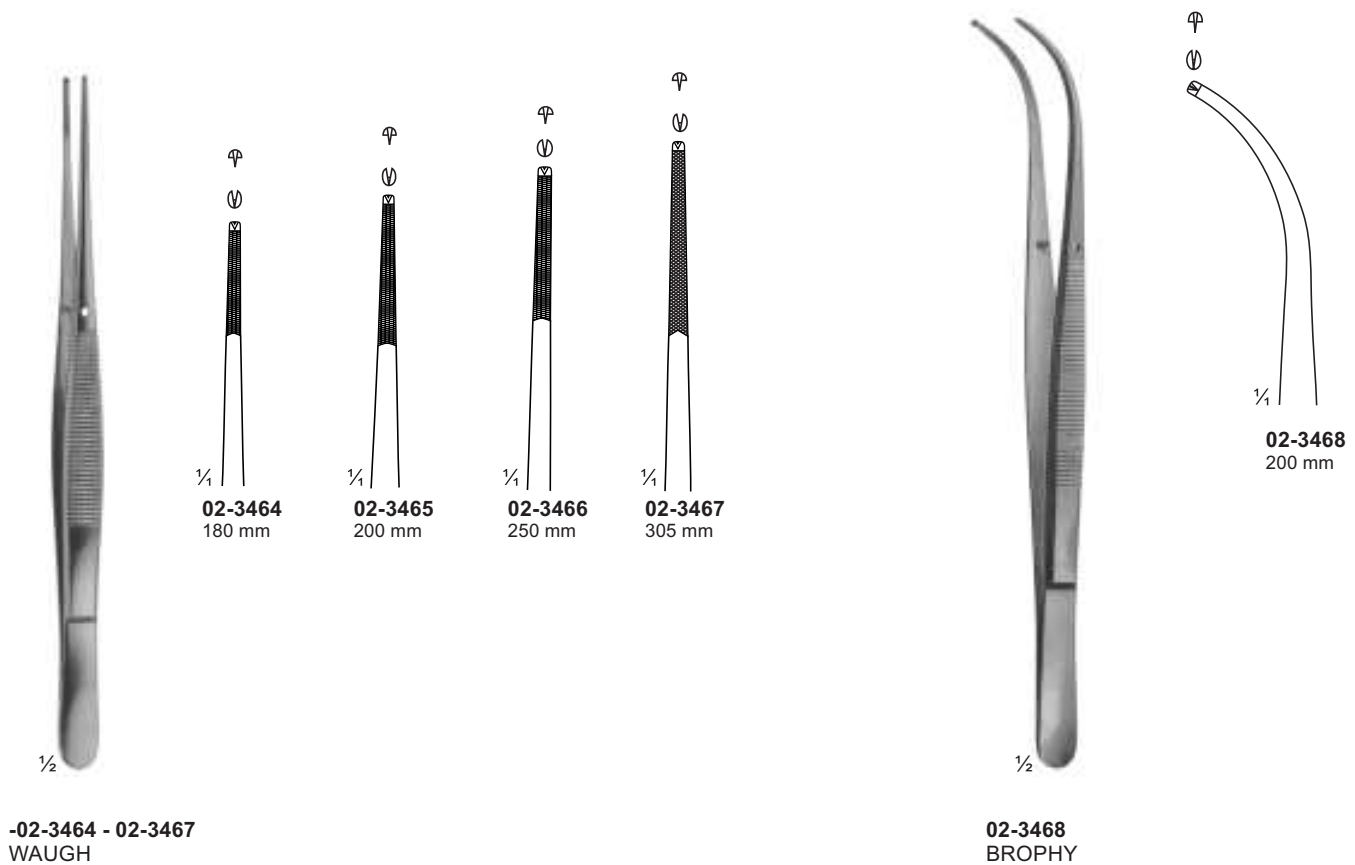
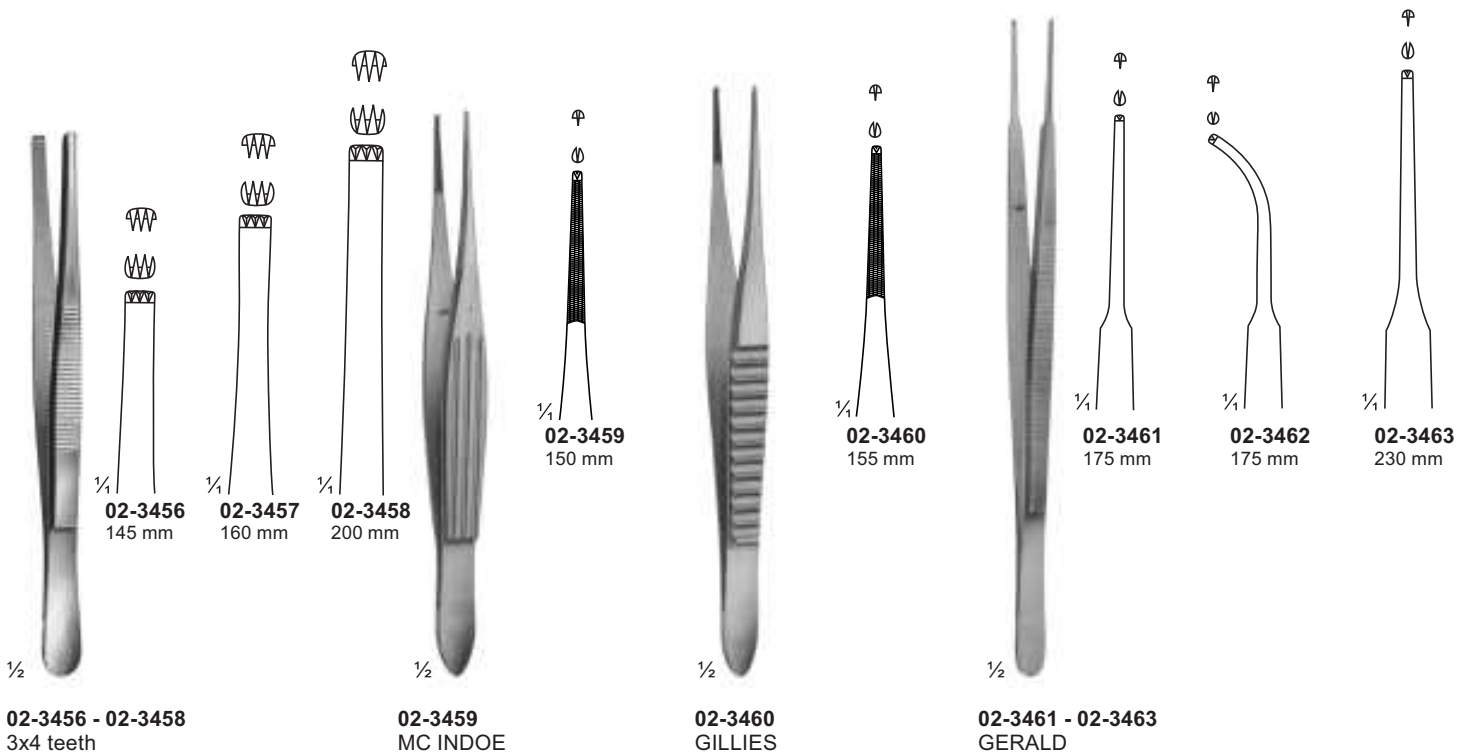

Tissue Forceps, Lung Dissecting Forceps, Intestinal Forceps

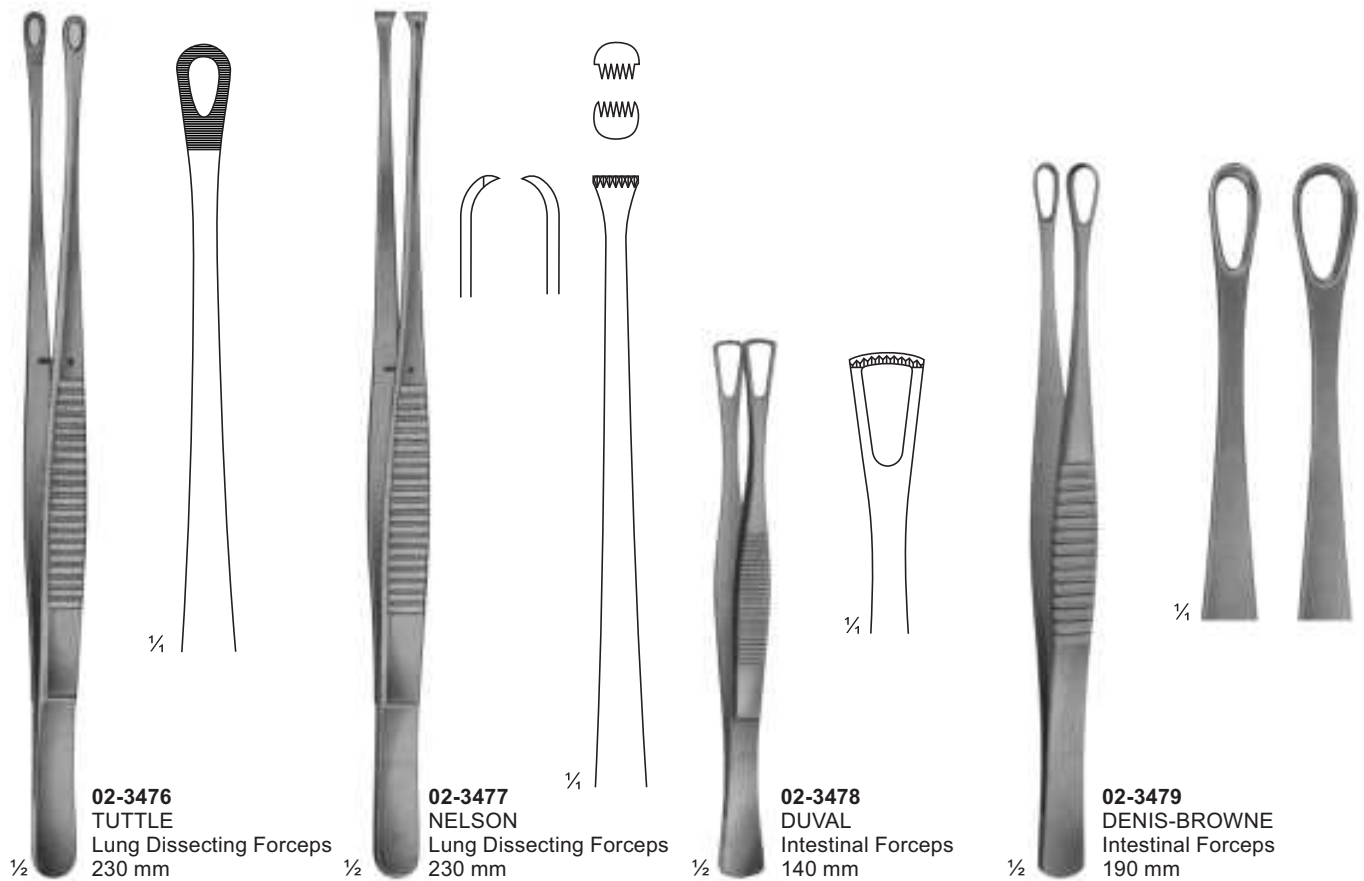
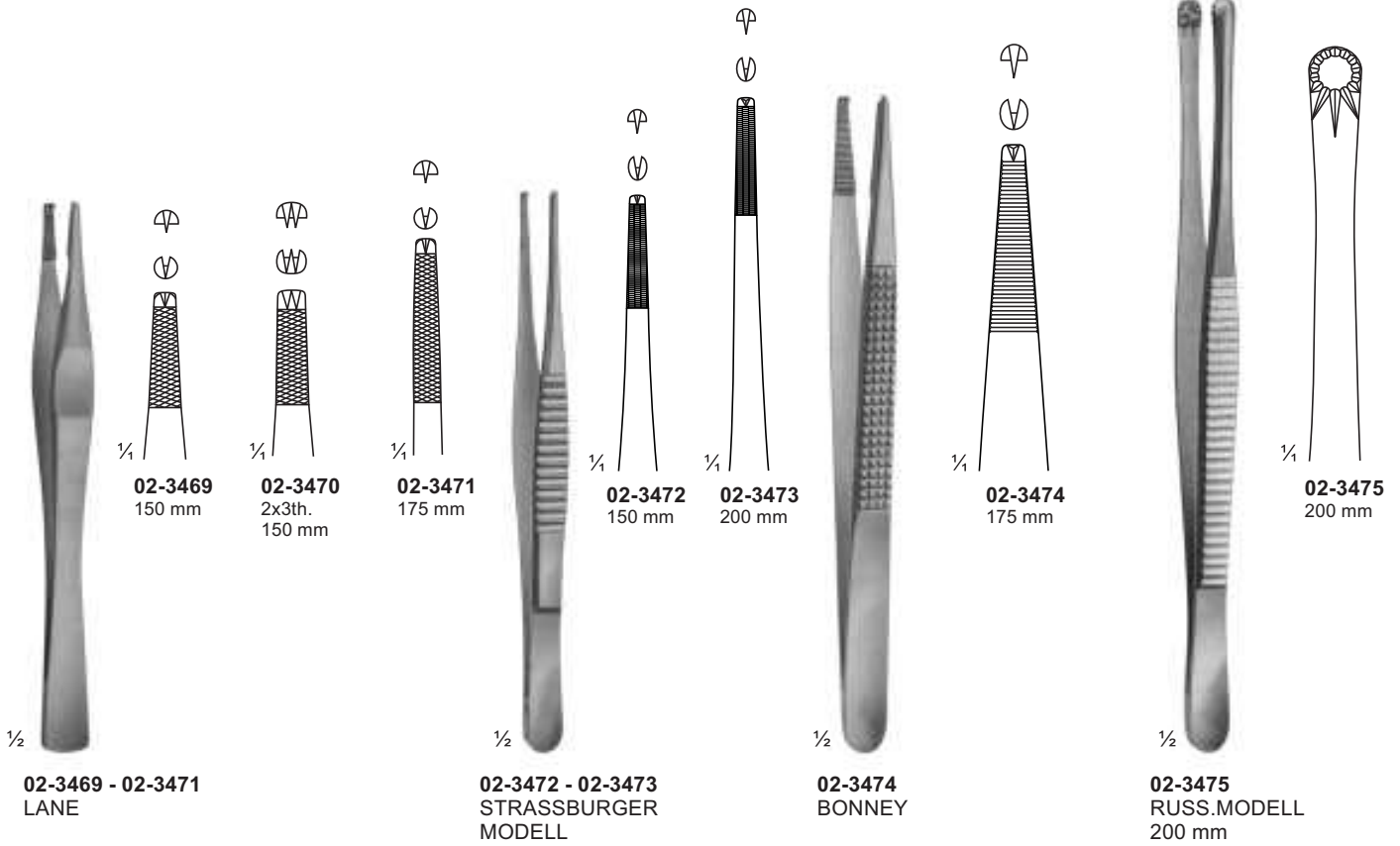

Splinter and Cilia Forceps

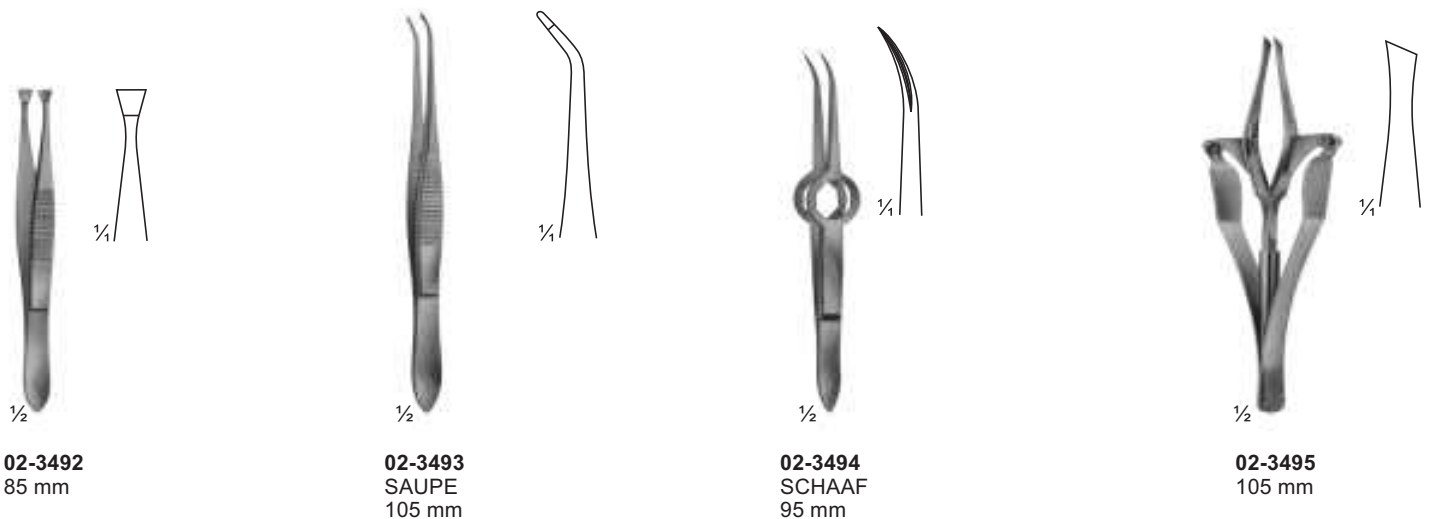
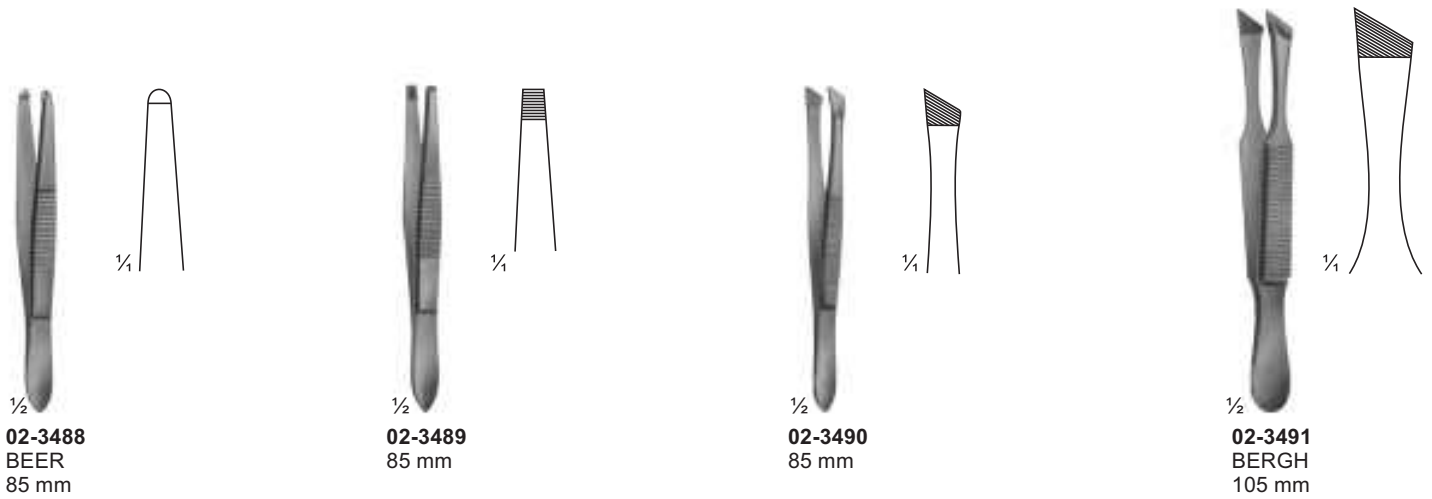
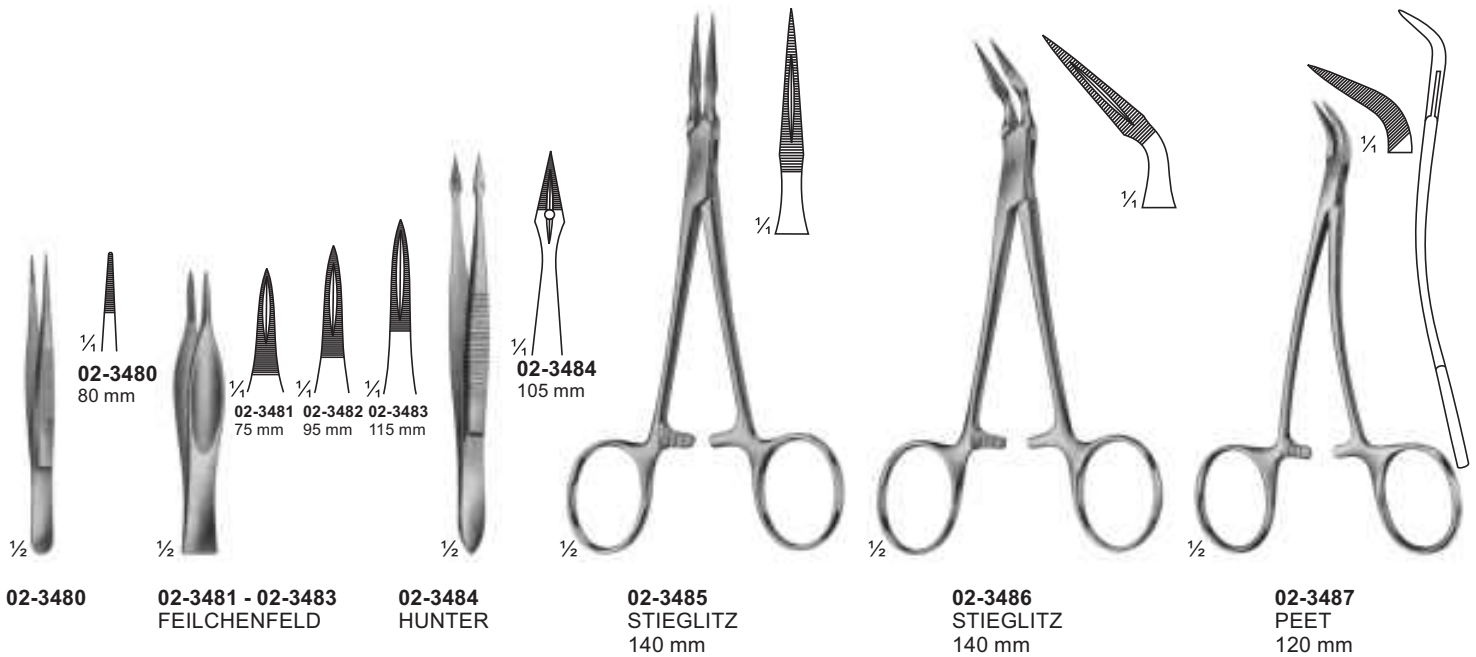

Sponge and Dressing Forceps

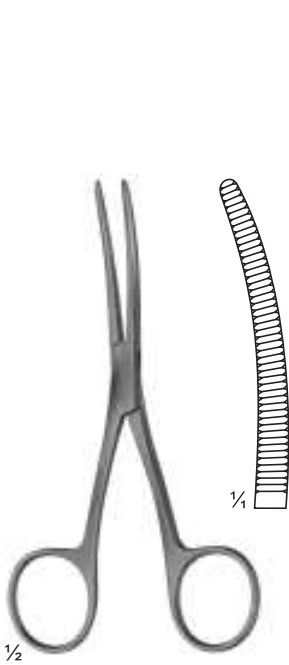

02-3496
BRYANT
130 mm

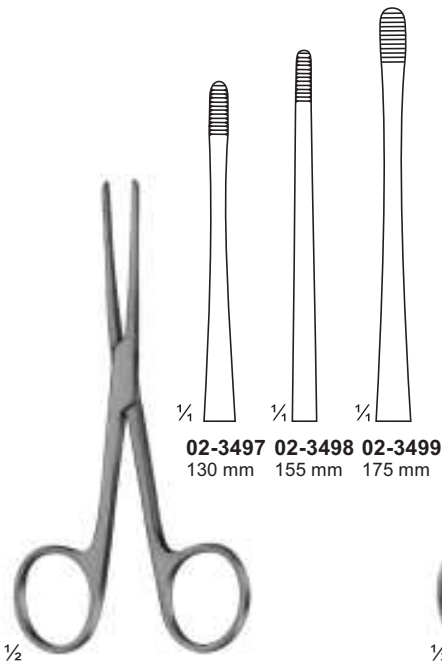

02-3497 - 02-3499
LISTER
Sinus Forceps

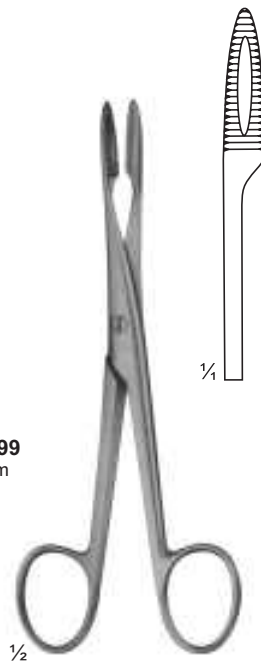

02-3500
Without Ratchet
145 mm

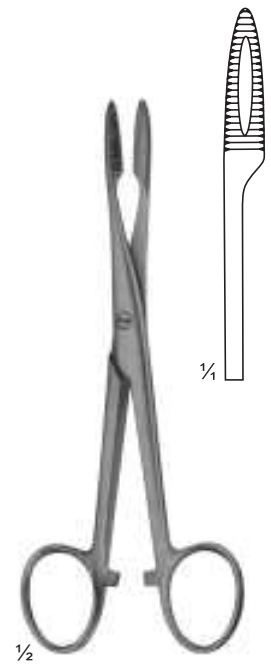

02-3501
With Ratchet
145 mm

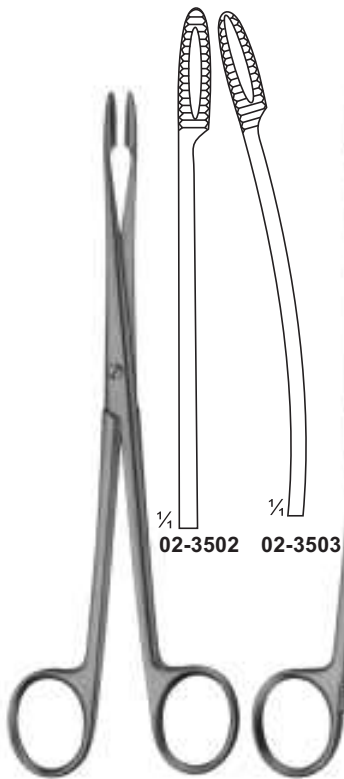

02-3502 - 02-3503
GROSS
Without Ratchet
180 mm

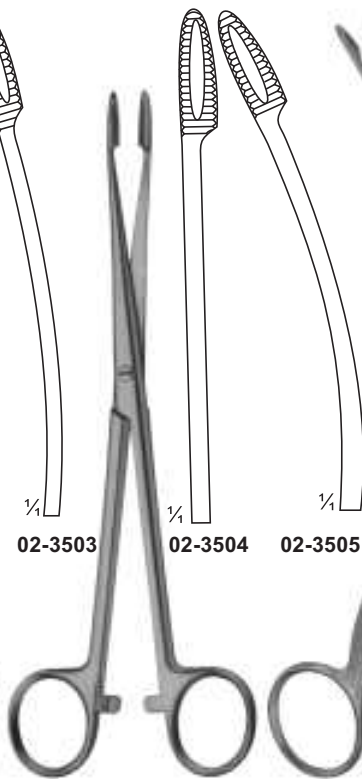

02-3504 - 02-3505
GROSS
With Ratchet
180 mm

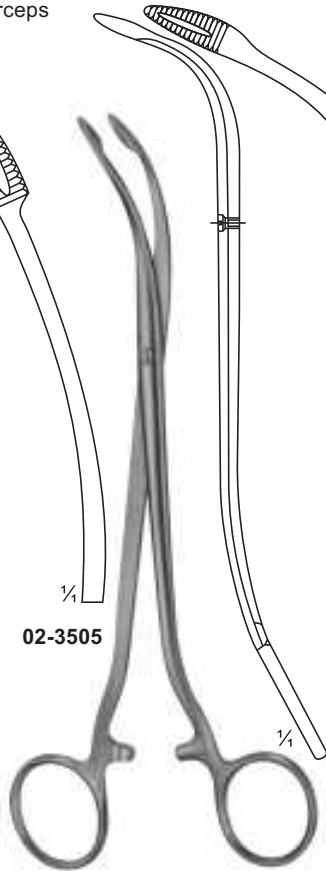

02-3506
DUPLAY
190 mm

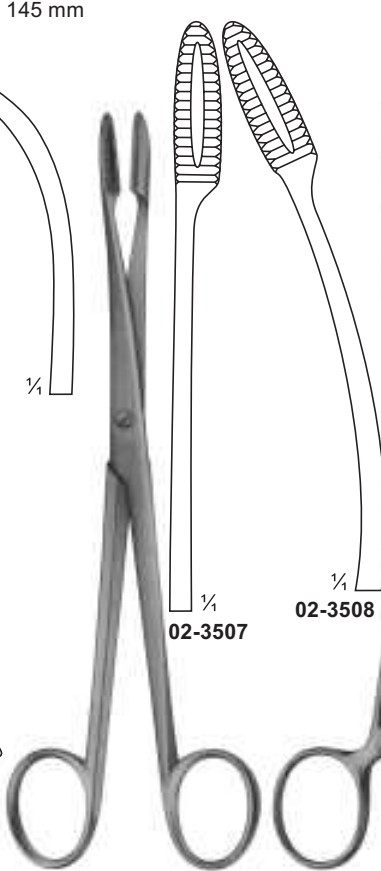

02-3507 - 02-3508
GROSS
Without Ratchet
200 mm

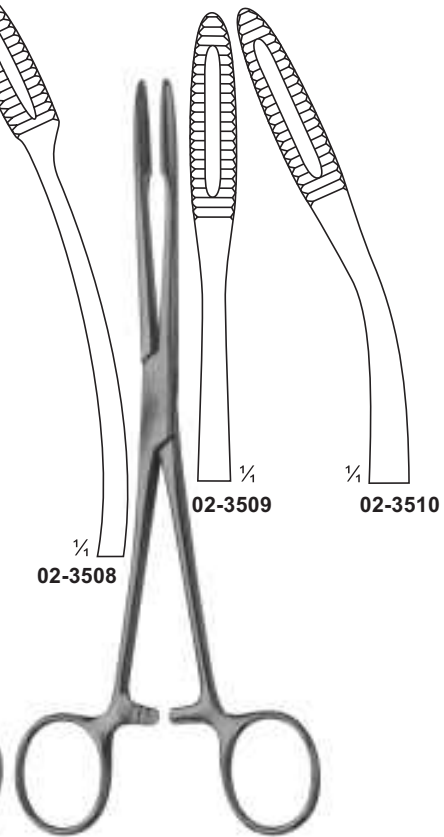

02-3509 - 02-3510
GROSS
With Ratchet
200 mm

Sponge and Dressing Forceps



02-3511 - 03-3512
ALM
220 mm

02-3513 - 02-3514
MAIER
Without Ratchet
265 mm

02-3515 - 02-3516
MAIER
With Ratchet
265 mm

Sponge and Dressing Forceps

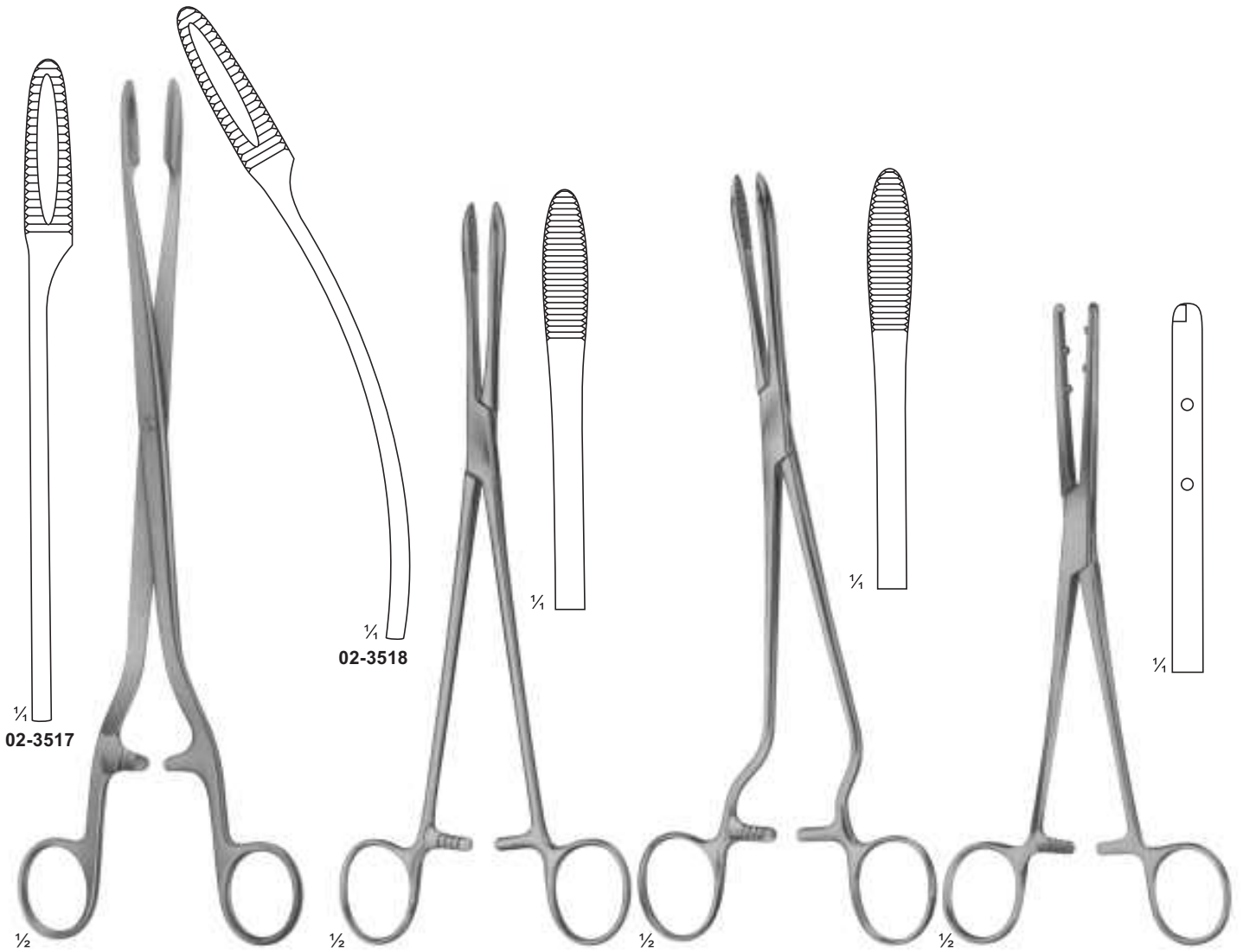

02-3517

02-3518

02-3519
COLLIN
240 mm

02-3520
CHERON
Handles Laterally Angled
240 mm

02-3521
EMMET
210 mm

02-3517 - 02-3518
SIMS-MAIER
280 mm

Dressing, Sponge Holding, Organ and Tissue Grasping Forceps and Haemostatic Forceps

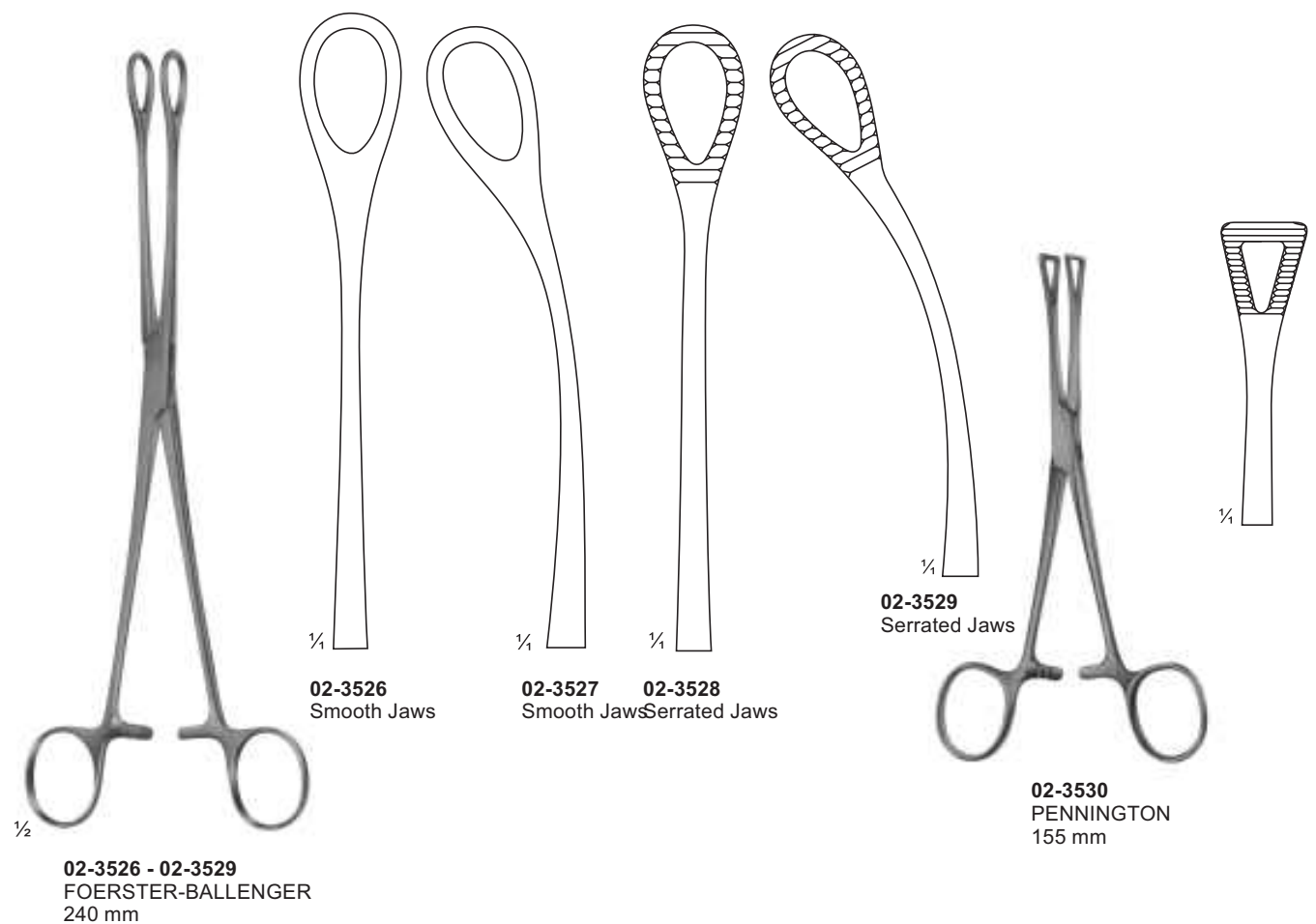
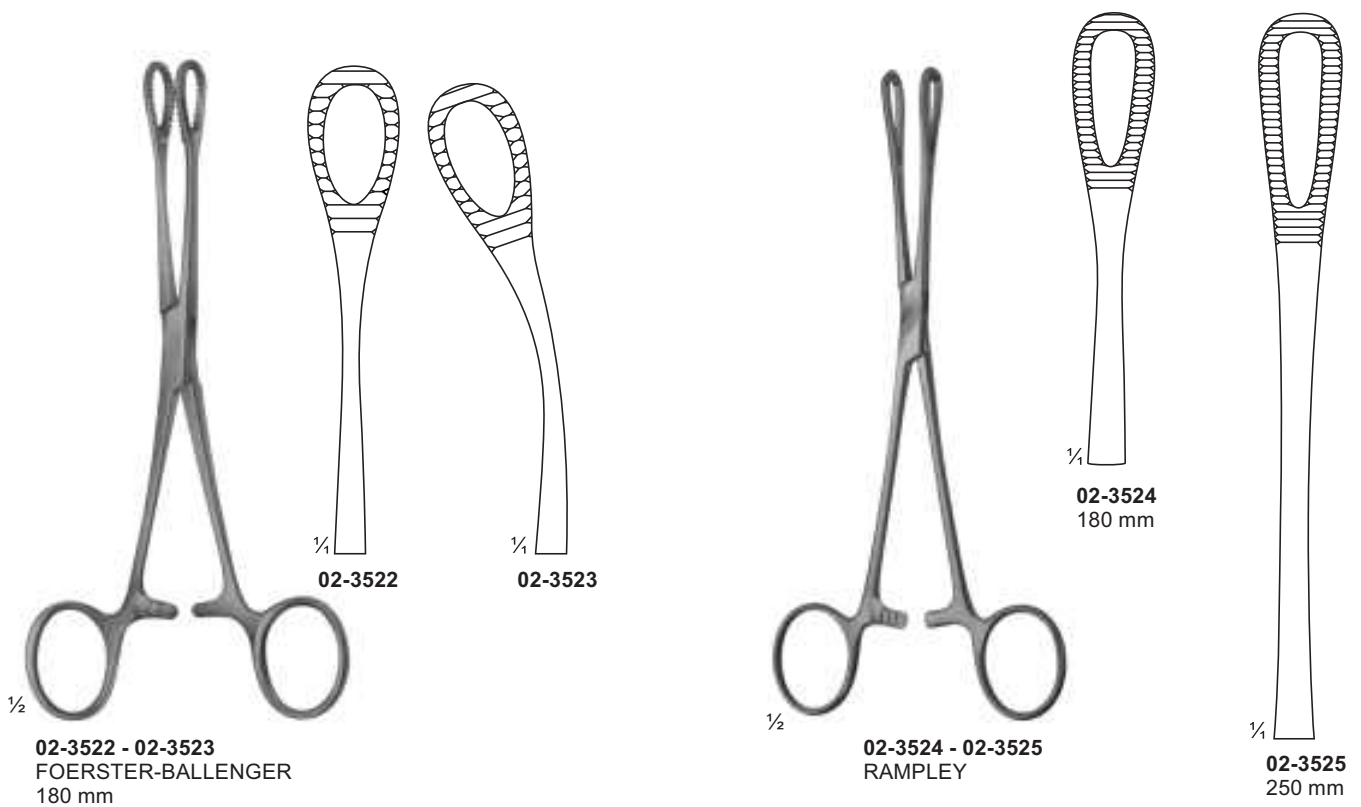

Dressing, Sponge holding, Organ and Tissue Grasping Forceps

ATRAUMATA

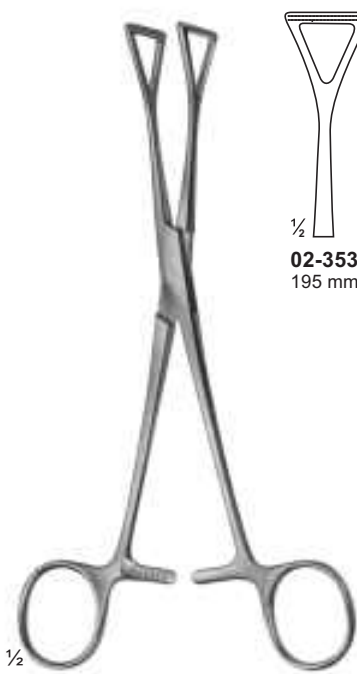

02-3531 - 02-3532
COLLIN



02-3531
195 mm

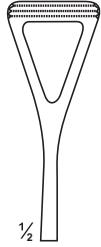

02-3532
230 mm

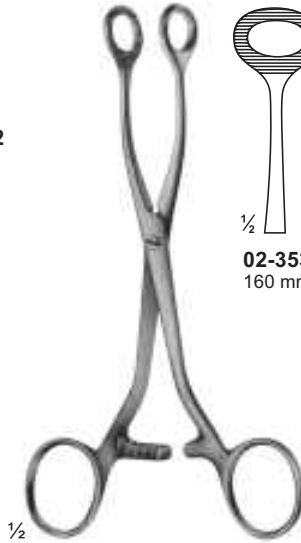

02-3533 - 02-3535
COLLIN

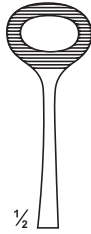

02-3533
160 mm



02-3534
160 mm

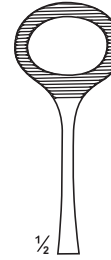

02-3535
170 mm

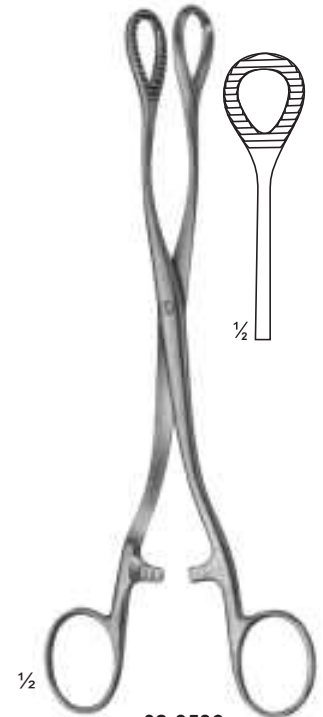

02-3536
HEYWOOD-SMITH
200 mm



02-3537
NOTO
280 mm

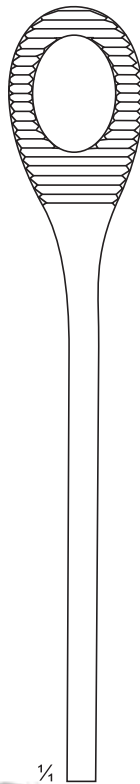

1/4



02-3538
KELLY
320 mm



1/4

Tendon Seizing Forceps

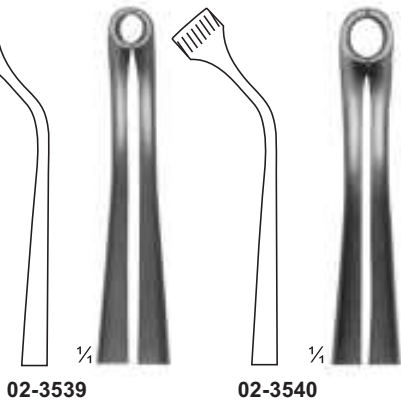
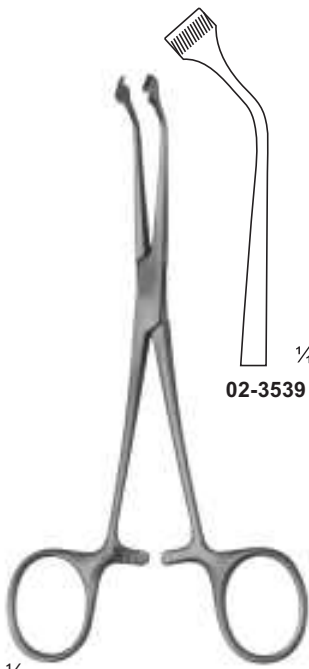

1/2
02-3539 - 02-3540
HERZ
155 mm

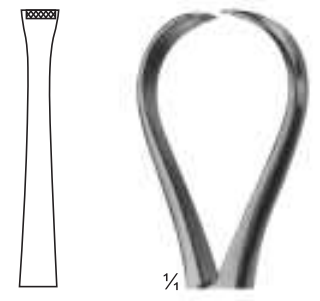

1/2
02-3541
JACKSON
4 x 5 teeth
150 mm

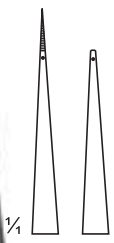
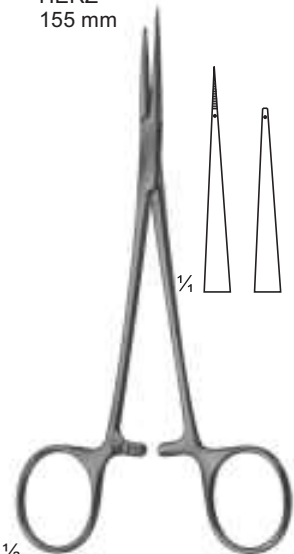

1/2
02-3542
Tendon interlacing
forceps
150 mm

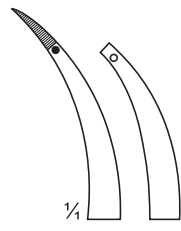
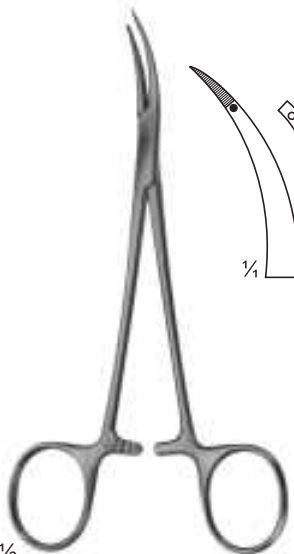

1/2
02-3543
Tendon interlacing
forceps
150 mm

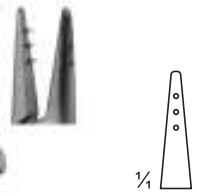

1/2
02-3544
Tendon seizing
forceps
120 mm

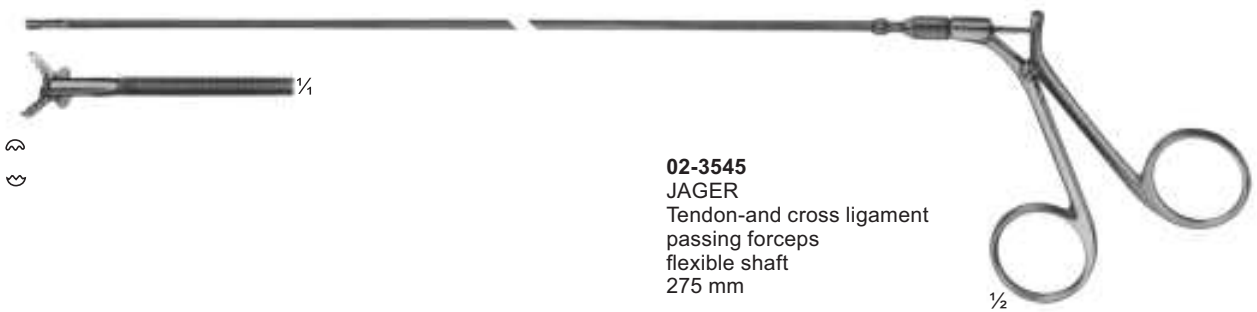

02-3545
JAGER
Tendon-and cross ligament
passing forceps
flexible shaft
275 mm

Artery Traction - and Tissue Grasping Force

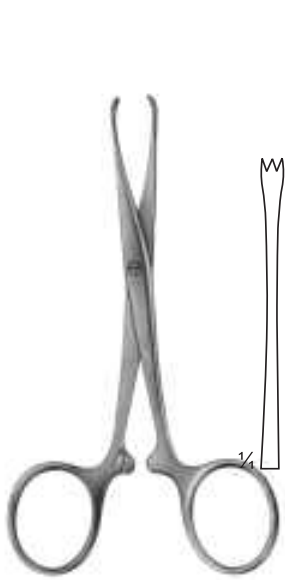

½

02-3546
CHAPUT
 2 x 3 teeth sharp
 125 mm

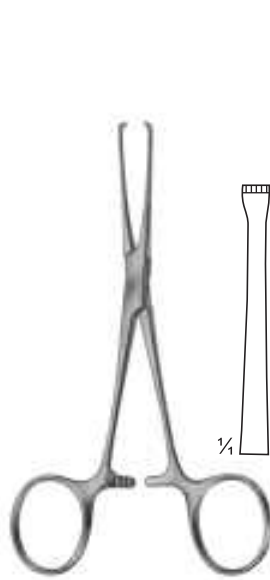

½

02-3547
BABY-ALLIS
 4 x 5 teeth
 130 mm



½

02-3548
BOYS-ALLIS
 5 x 6 teeth sharp
 155 mm

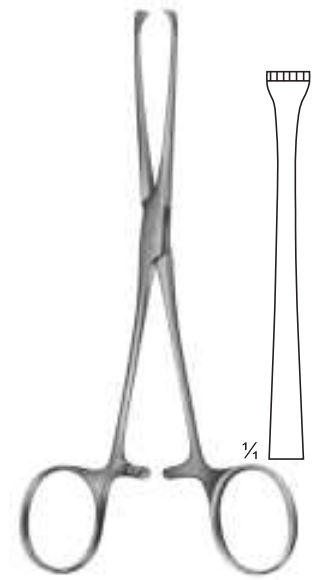

½

02-3549
ALLIS
 5 x 6 teeth blunt
 155 mm

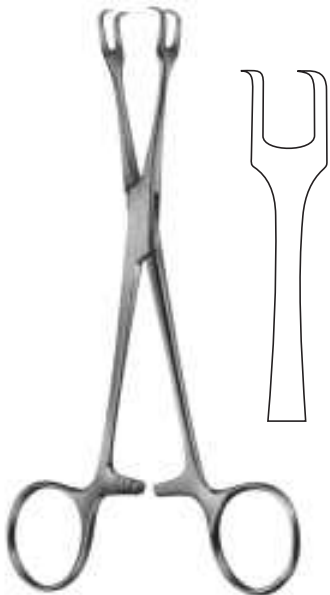

½

02-3550
LAHEY
 155 mm

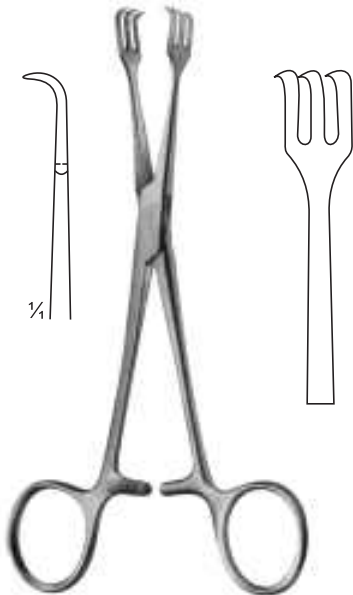

½

02-3551
LAHEY
 155 mm

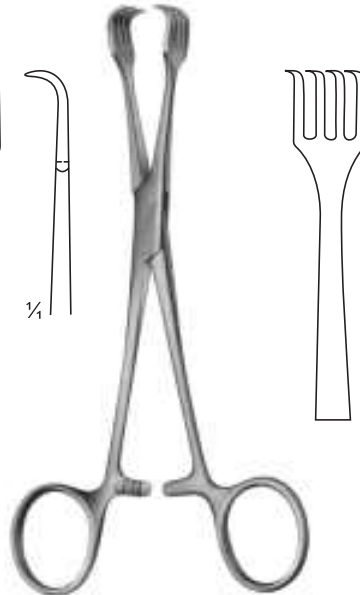

½

02-3552
BRAUN
 155 mm

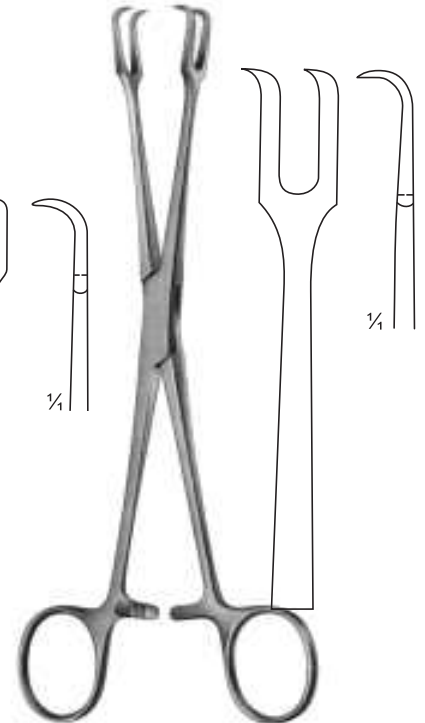

½

02-3553
MUSEUX
 200 mm

Organ - and Tissue Grasping Forceps

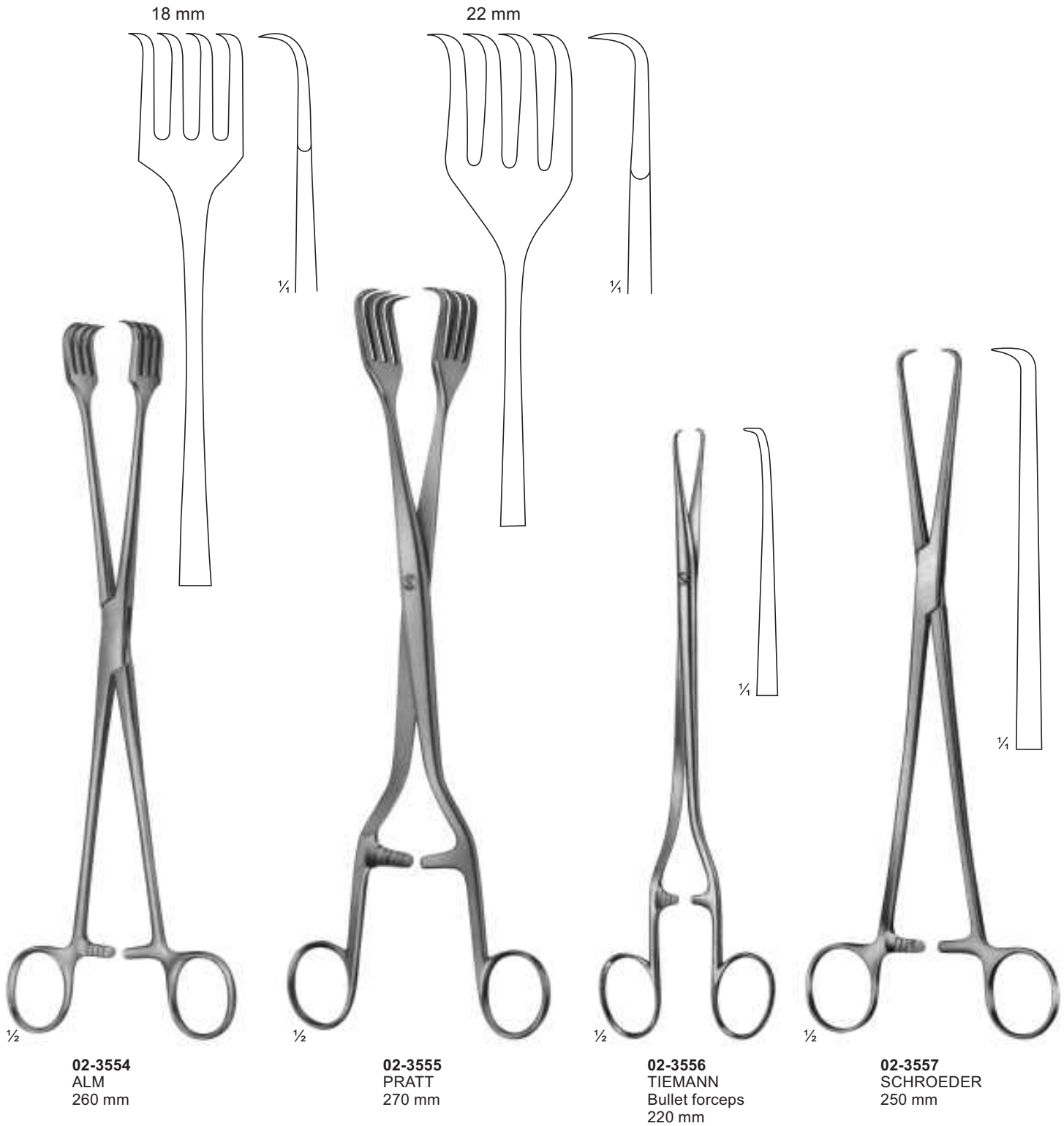

Towel Clamps

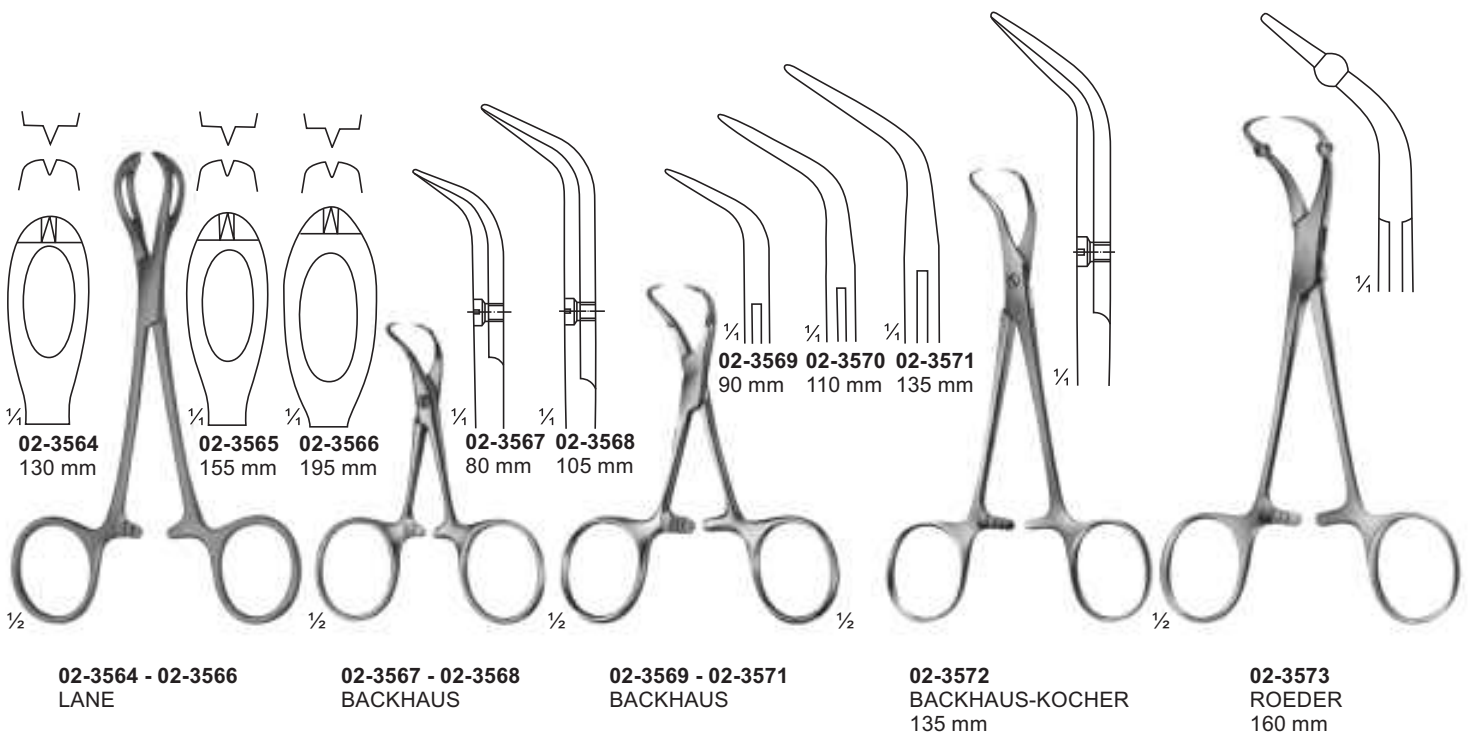
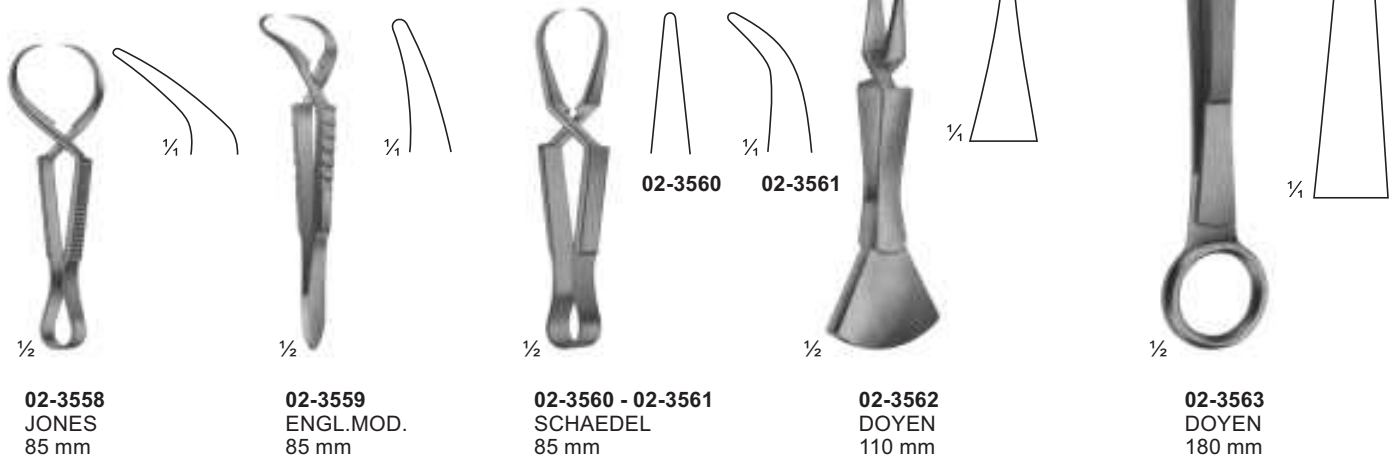

Towel Clamps and Safety Pins.

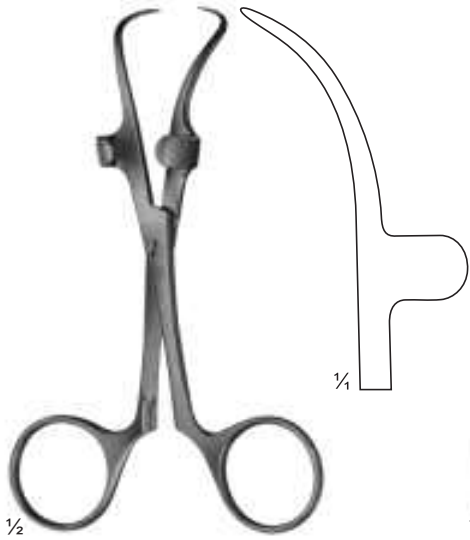

02-3574
ROBIN
 with holders for tubing
 up to 13 mm
 135 mm

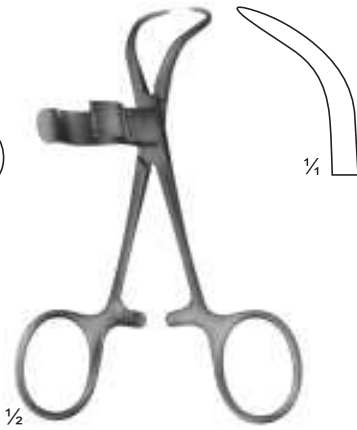

02-3575
 with clip for tubing
 up to 15 mm
 110 mm

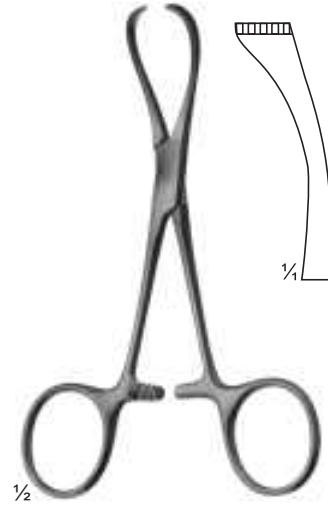

02-3576
LORNA
 non perforating
 130 mm

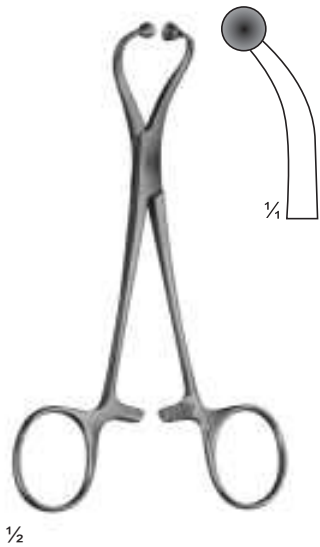

02-3577
 for paper cloths
 140 mm



02-3578
BUNT
 105 mm



02-3579
MAYO
 140 mm

Muller Vessel Clips and Bulldog Clamps



Closing force



02-3580
Straight
50g



02-3581
80g



02-3582
Curved
50g



02-3583
80g



02-3584
Curved tips
50g



02-3585
80g



02-3586
Angled
Shaped
50g



02-3587
80g



02-3588
Muller
Knee-bent
50g

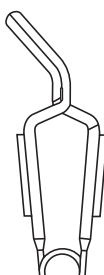

02-3589
80g



02-3590
Muller
Ligature Forceps



Jaw, cross
serrated
Jaws profiles
finally cross-
serrated.

Non-traumatic vessel clips, temporary.



02-3591
38 mm
48 mm



02-3592
38 mm
48 mm



02-3593
58 mm



02-3594
58 mm



02-3595 - 02-3601

- 02-3595** 38 mm
- 02-3596** 48 mm
- 02-3597** 56 mm
- 02-3598** 63 mm
- 02-3599** 70 mm
- 02-3600** 80 mm
- 02-3601** 91 mm



02-3602
DE BAKEY-
HESS
Length of
Jaws 20 mm

Bulldog Clamps



02-3603
35 mm



02-3604
35 mm



02-3605
45 mm



02-3606
45 mm



DE BAKEY

02-3607
Length
50 mm
Jaws
27 mm



DE BAKEY

02-3608
Length
48 mm
Jaws
27 mm



75°

02-3609
GLOVER
Length
57 mm
Jaws 35 mm



02-3610
DE BAKEY
Length 73 mm
Jaws 38 mm

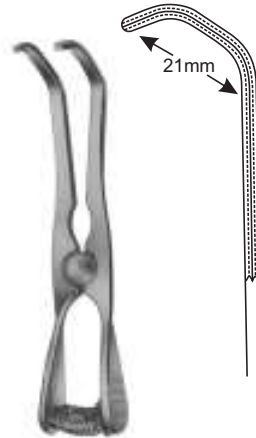

02-3611
DE BAKEY
Length 99 mm
Jaws 63 mm



02-3612
DE BAKEY
Length 95 mm
Jaws 54 mm



DE BAKEY

	Total length	Length of jaw
02-3613	80mm	25mm
02-3614	90mm	35mm
02-3615	105mm	50mm
02-3616	124mm	68mm



DE BAKEY

	Total length	Length of jaw
02-3617	78mm	25mm
02-3618	86mm	35mm
02-3619	97mm	50mm
02-3620	114mm	68mm



GLOVER

	Total length	Length of jaw
02-3621	68mm	33mm
02-3622	96mm	50mm
02-3623	117mm	69mm



GLOVER

	Total length	Length of jaw
02-3624	65mm	33mm
02-3625	91mm	50mm
02-3626	110mm	69mm

Delicate Haemostatic Forceps



02-3627
CARREL
85 mm



02-3628 - 02-3631
BABY-MOSQUITO
(HARTMANN)
100 mm



02-3632 - 02-3635
MICRO-HALSTED
125 mm



02-3636 - 02-3639
HALSTED-MOSQUITO
125 mm

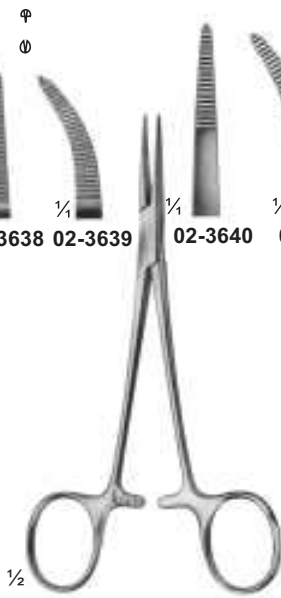

02-3640 - 02-3641
PROVIDENCE-HOSPITAL
140 mm



02-3642 - 02-3643
KELLY
140 mm

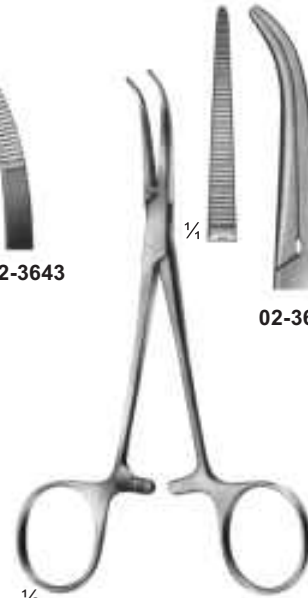

02-3644 - 02-3645
DANDY
Curved sideways
140 mm

Delicate Haemostatic Forceps

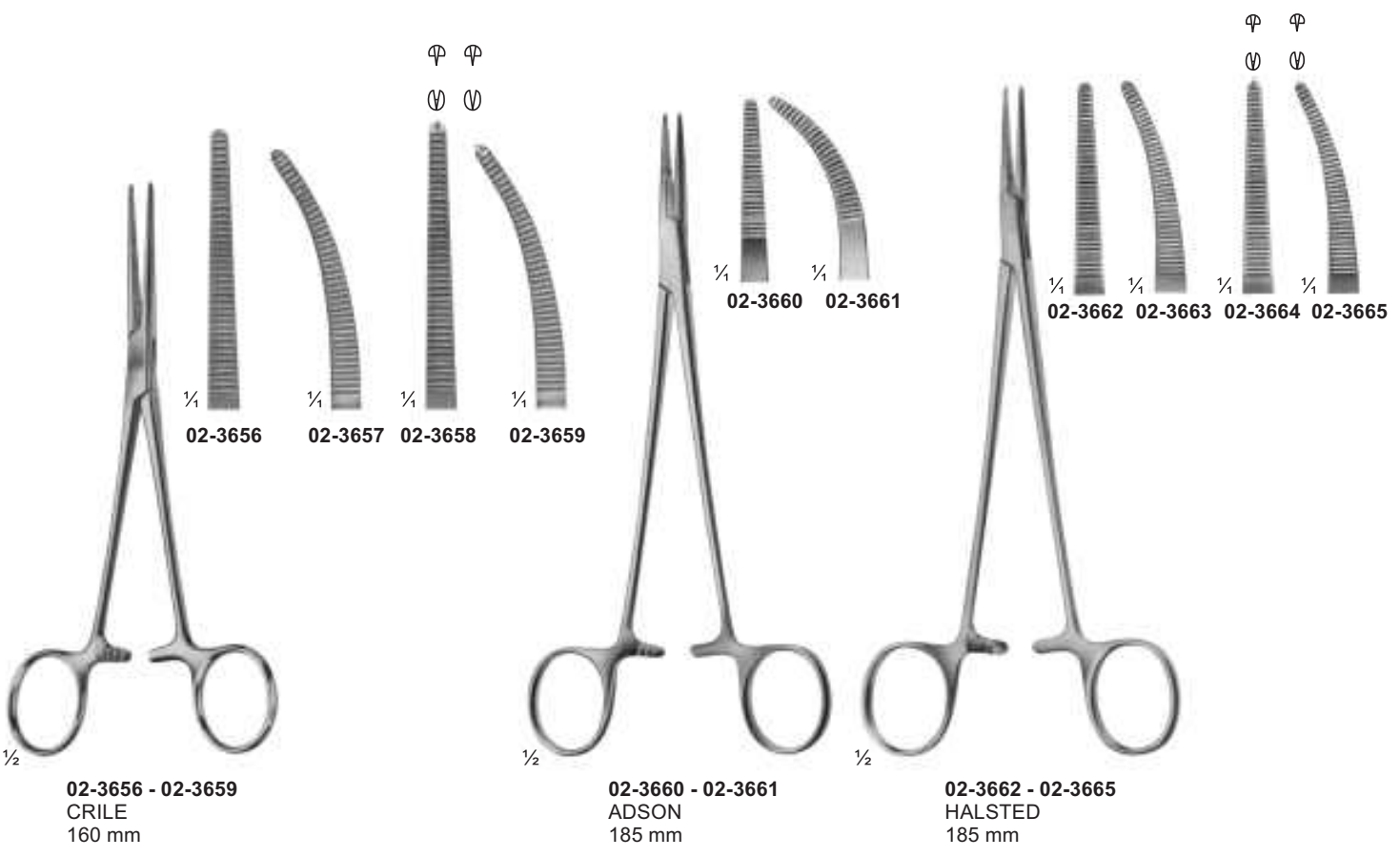
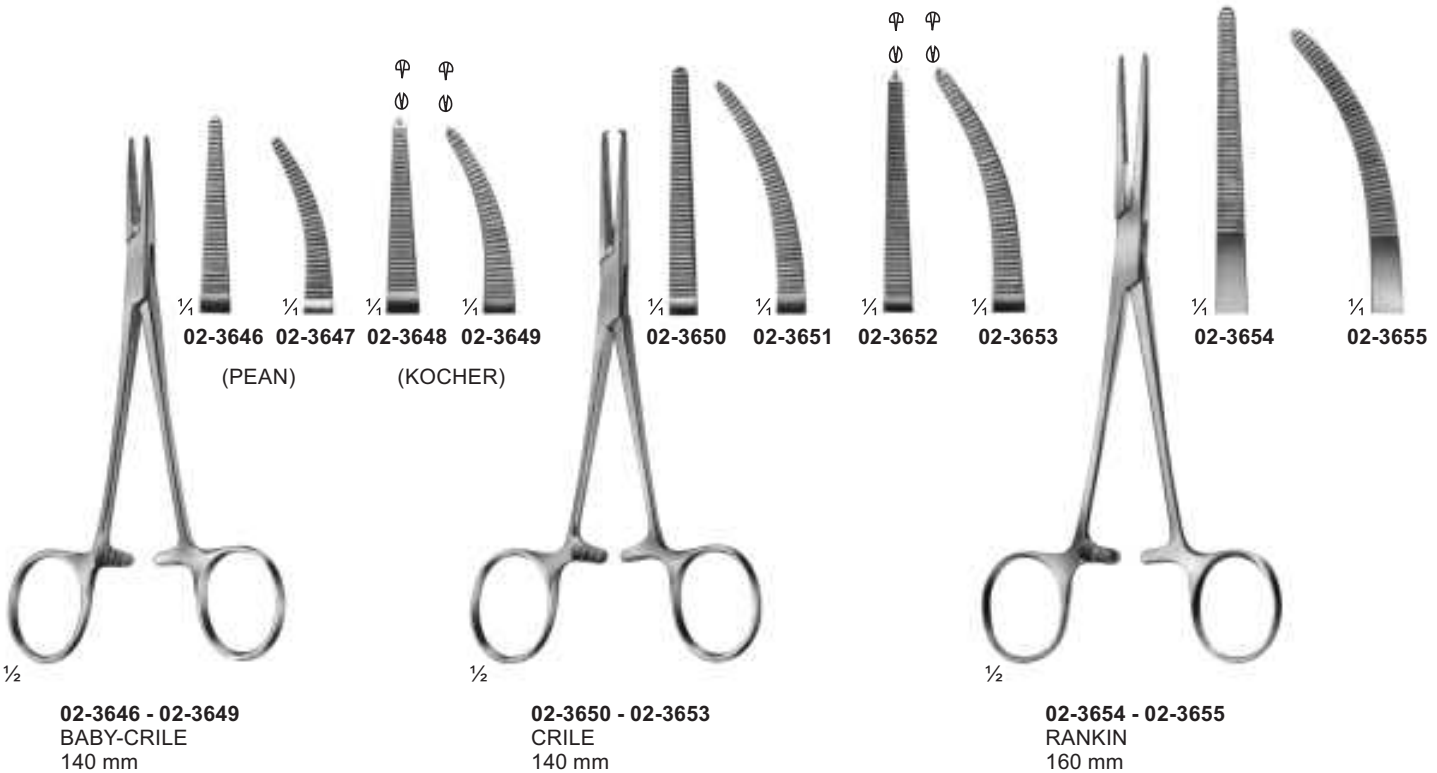

Delicate Haemostatic Forceps

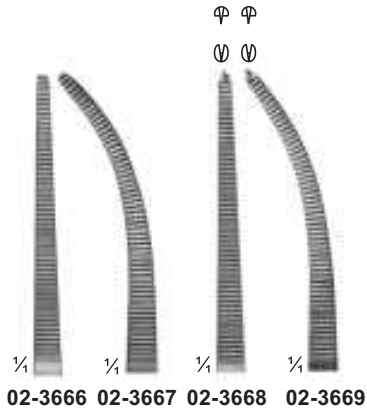
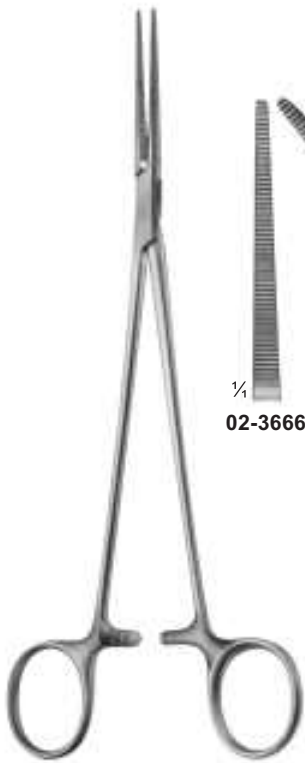

$\frac{1}{2}$
02-3666 - 02-3669
 HALSTED-MOSQUITO
 200 mm

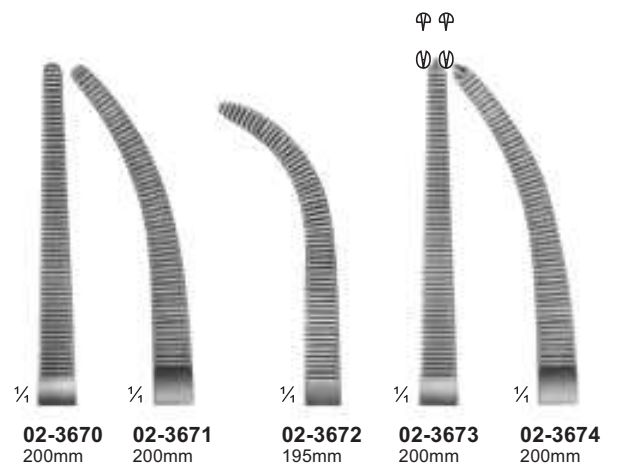
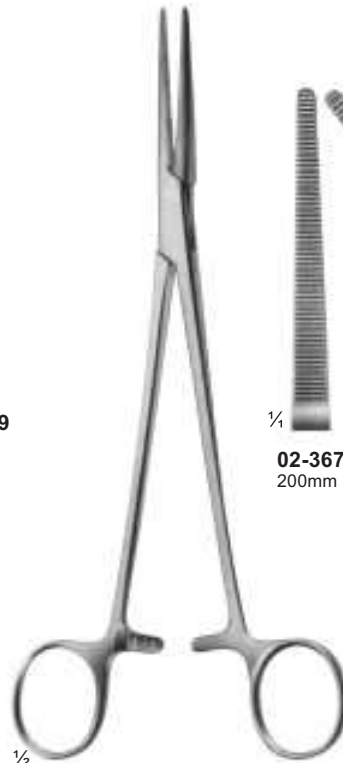

02-3670 - 02-3674
 HEISS

$\frac{1}{2}$



02-3675 - 02-3676
 HALSTED
 215 mm

$\frac{1}{2}$

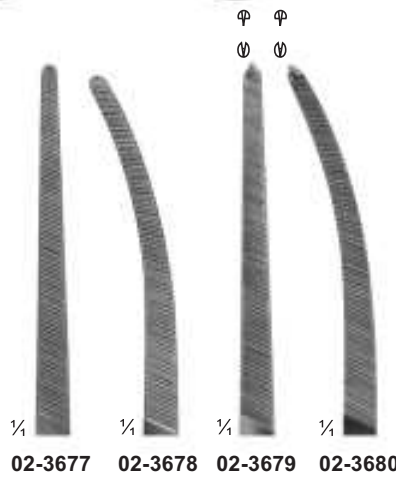
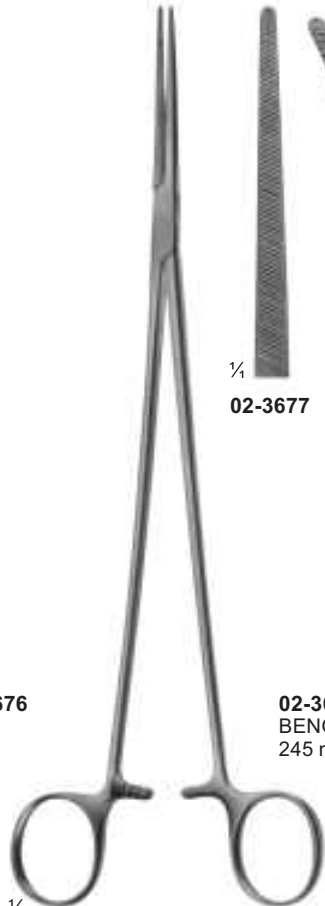

02-3677 - 02-3680
 BENGOLEA
 245 mm

$\frac{1}{2}$



02-3681
 CRAFOORD
 245 mm

$\frac{1}{2}$

Haemostatic Forceps

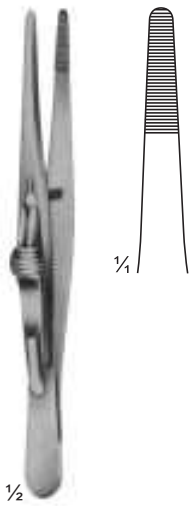

02-3682
FRICKE
Artery forceps
130 mm



02-3683
KRONLEIN
130 mm

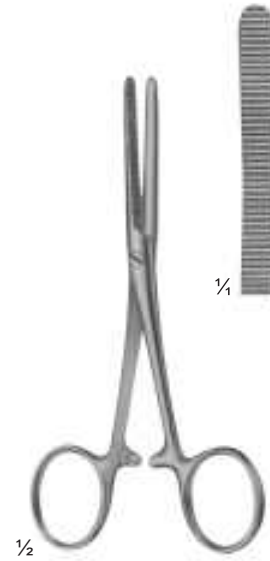

02-3684
PEAN
125 mm

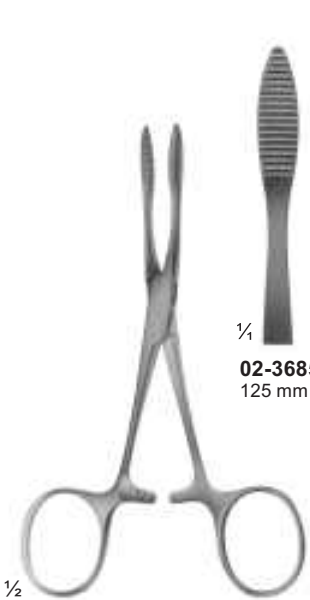

02-3685 - 02-3686
PEAN



02-3686
140 mm

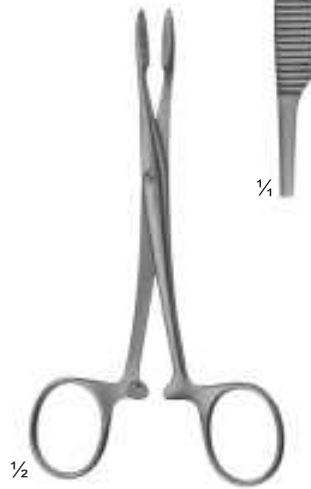

02-3687
PEAN
125mm

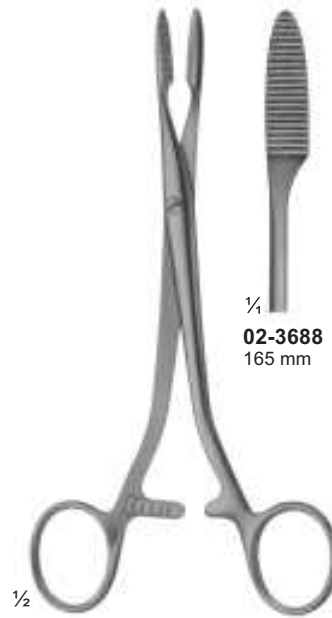

02-3688 - 02-3689
PEAN



02-3688
165 mm



02-3689
185 mm

Haemostatic Forceps



$\frac{1}{4}$	$\frac{1}{4}$	$\frac{1}{4}$	$\frac{1}{4}$	$\frac{1}{4}$	$\frac{1}{4}$	$\frac{1}{4}$	$\frac{1}{4}$	$\frac{1}{4}$	$\frac{1}{4}$	$\frac{1}{4}$	$\frac{1}{4}$	$\frac{1}{4}$
02-3690 130 mm	02-3691 140 mm	02-3692 130 mm	02-3693 140 mm	02-3695 130 mm	02-3696 150 mm	02-3697 175 mm	02-3698 200 mm	02-3699 130 mm	02-3700 150 mm	02-3701 175 mm	02-3702 200 mm	

$\frac{1}{2}$ **02-3690 - 02-3693**
PEAN
Slender type

$\frac{1}{2}$ **02-3694 - 02-3702**
SPENCER-WELLS

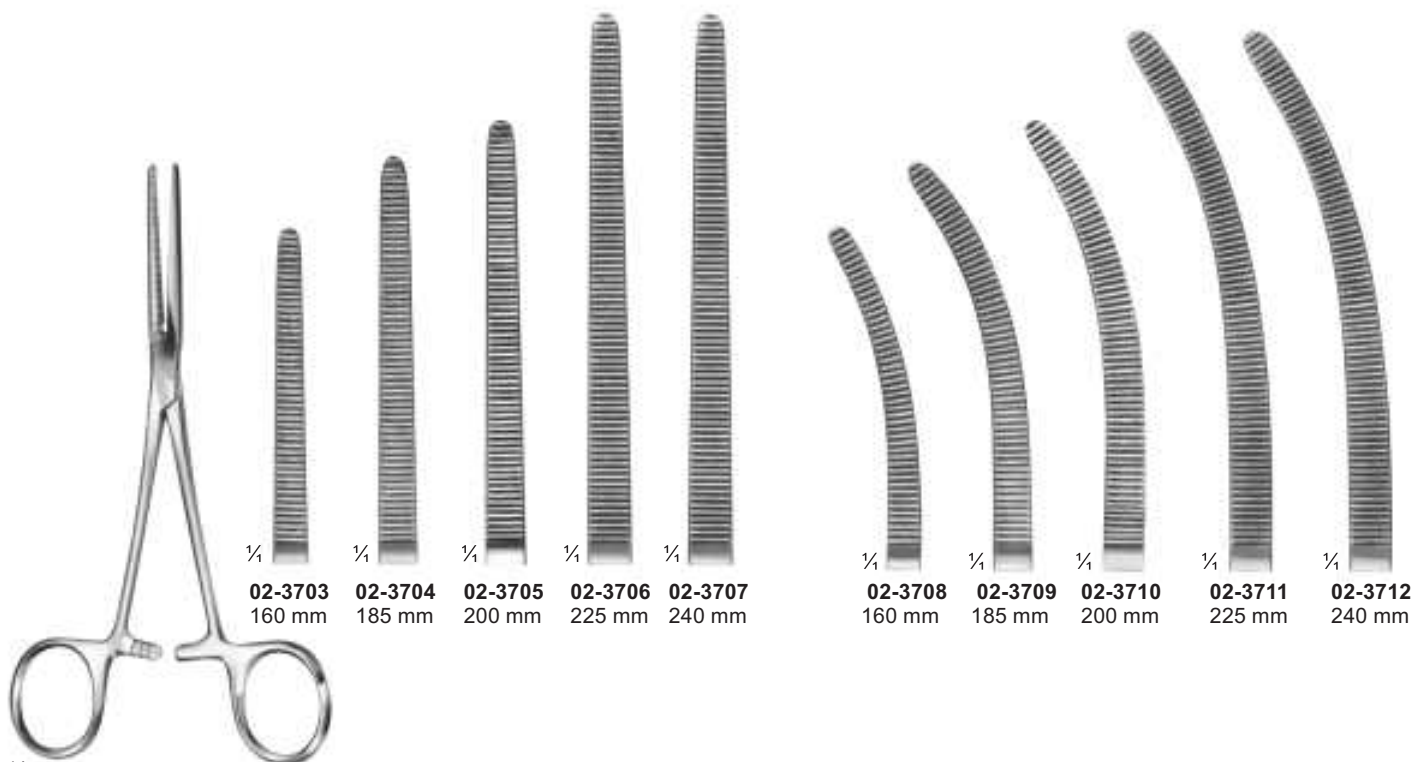

$\frac{1}{4}$	$\frac{1}{4}$	$\frac{1}{4}$	$\frac{1}{4}$	$\frac{1}{4}$	$\frac{1}{4}$	$\frac{1}{4}$	$\frac{1}{4}$	$\frac{1}{4}$	$\frac{1}{4}$
02-3703 160 mm	02-3704 185 mm	02-3705 200 mm	02-3706 225 mm	02-3707 240 mm	02-3708 160 mm	02-3709 185 mm	02-3710 200 mm	02-3711 225 mm	02-3712 240 mm

$\frac{1}{2}$ **02-3703 - 02-3712**
ROCHESTER-PEAN

Haemostatic Forceps



02-3713 - 02-3718
PEAN

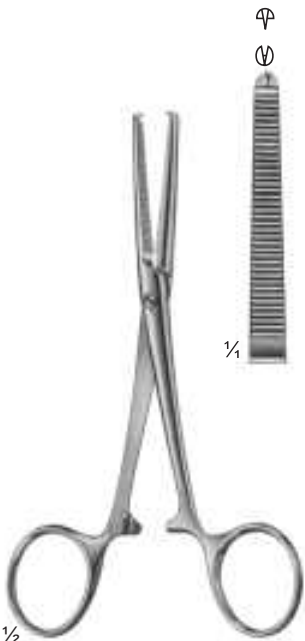
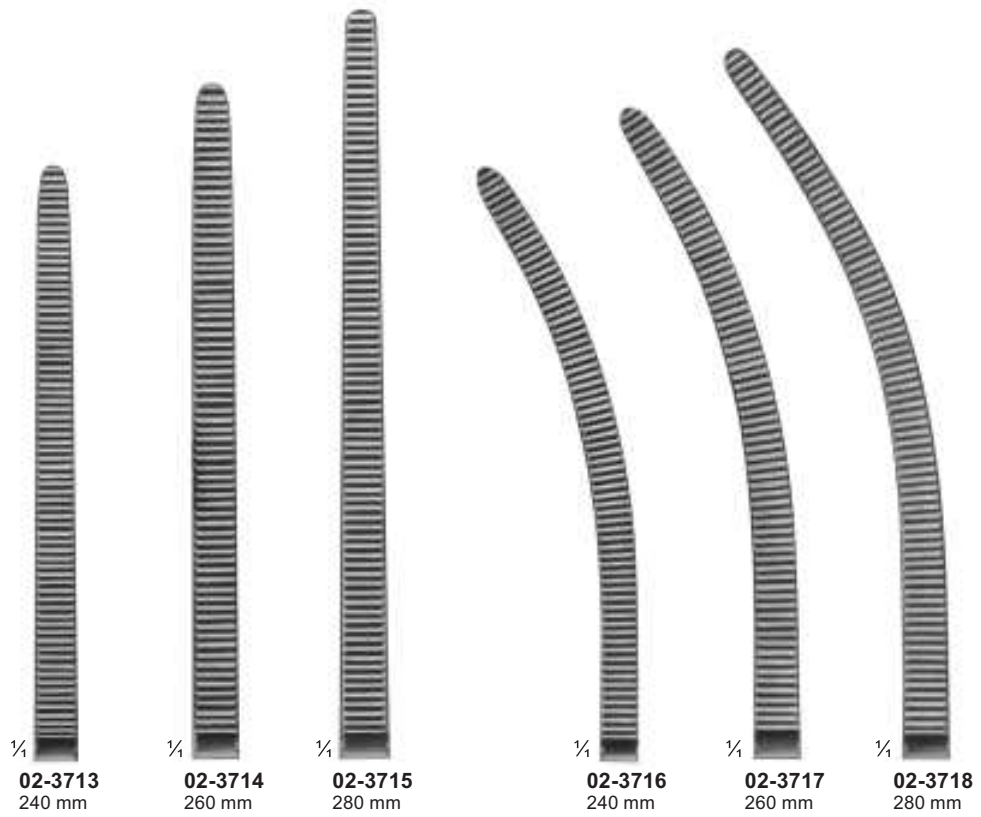

02-3719
KOCHER
Strong Pattern
145 mm

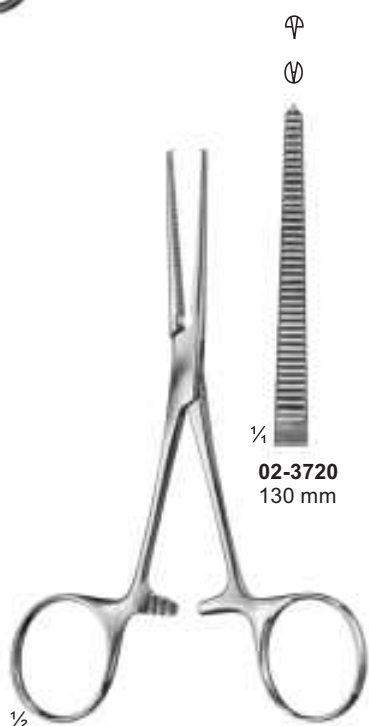

02-3720 - 02-3722
KOCHER

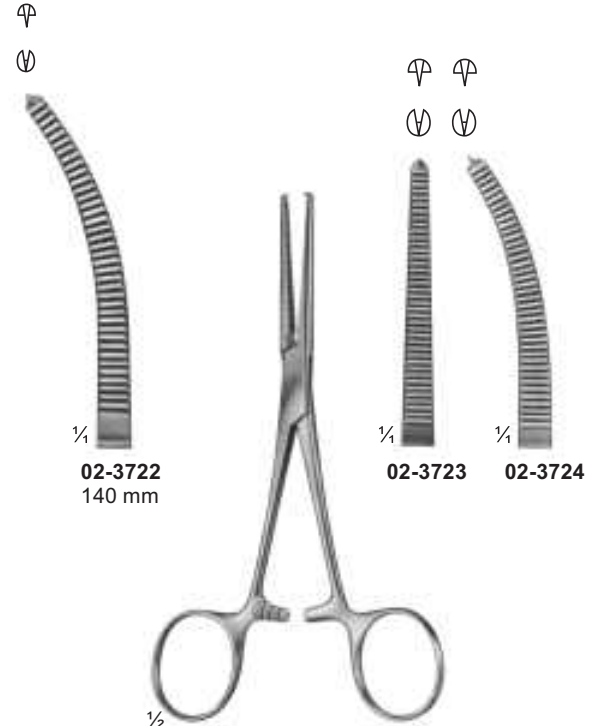

02-3723 - 02-3724
ROCHESTER-OCHSNER
140 mm

Haemostatic Forceps

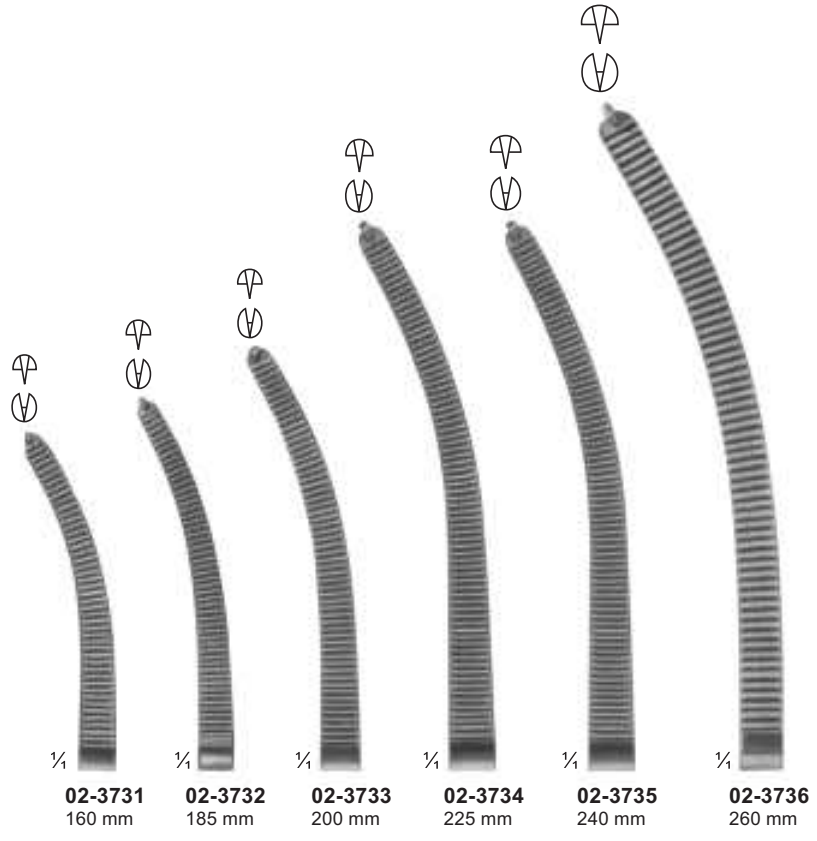
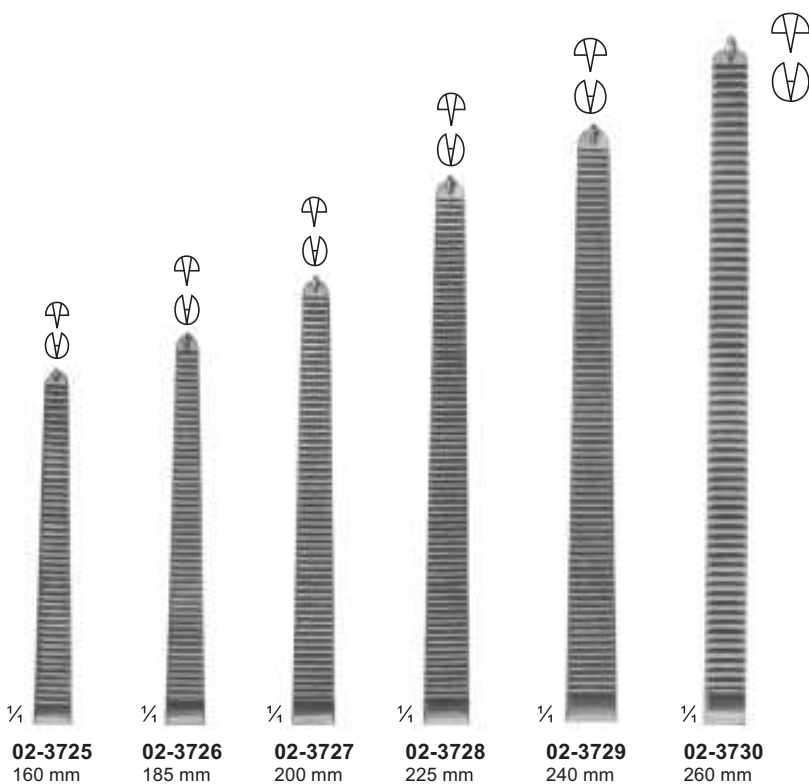

02-3725 - 02-3736
KOCHER-OCHSNER

Haemostatic Forceps, Special Pattern, Tonsil Forceps

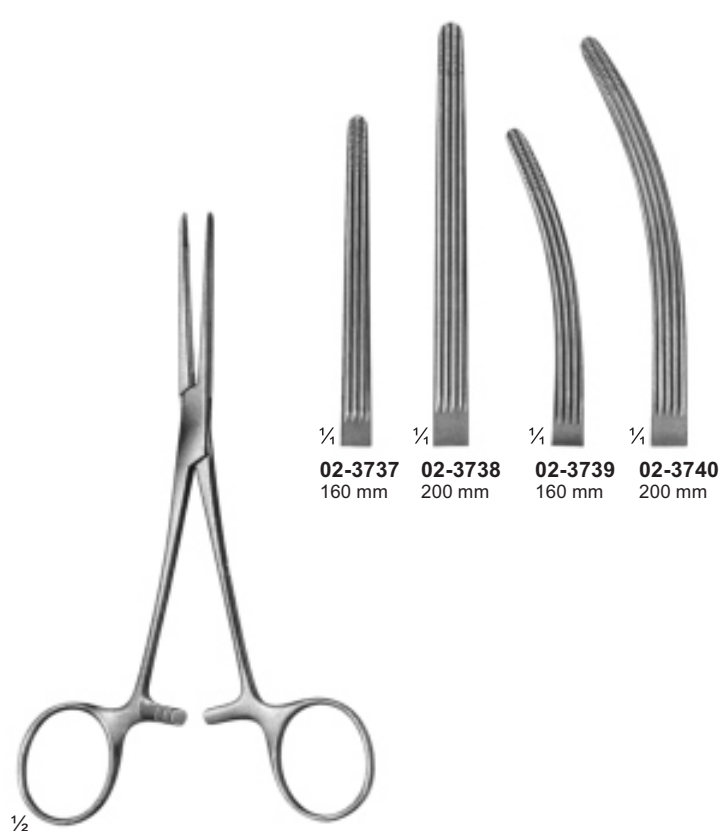

02-3737 - 02-3740
ROCHESTER-CARMALT

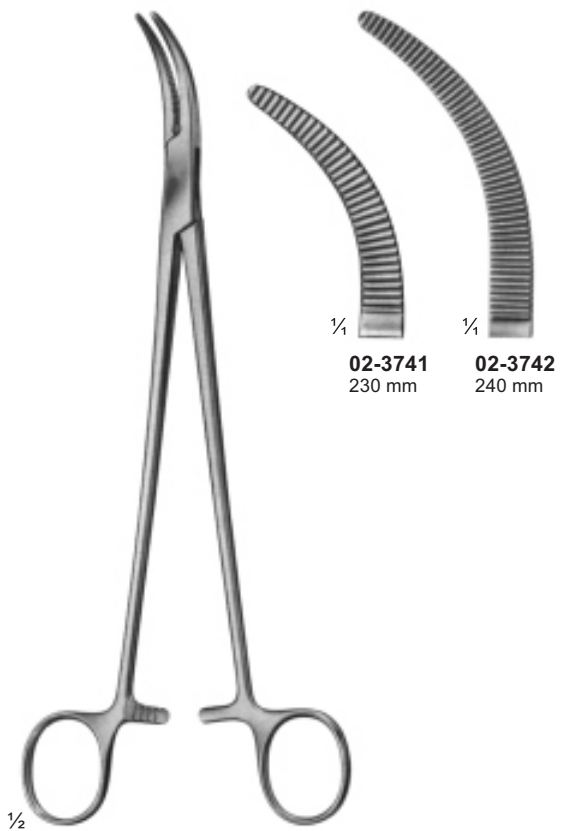

02-3741 - 02-3742
MOYNIHAN

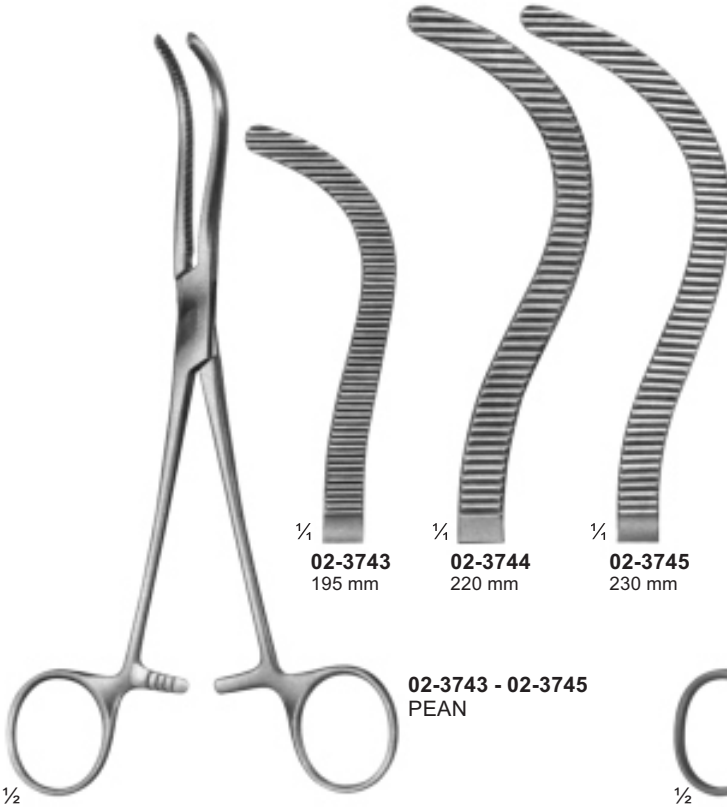

02-3743 - 02-3745
PEAN

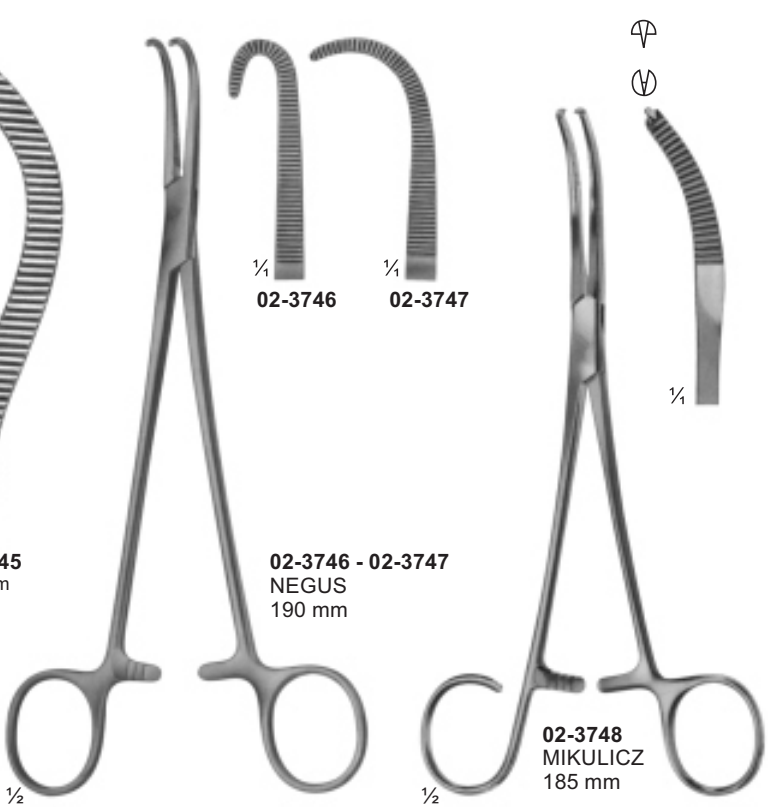

02-3746 - 02-3747
NEGUS
190 mm

02-3748
MIKULICZ
185 mm

Dissecting- and Ligature Forceps



02-3749
MICRO-ADSON
140 mm



02-3750
BABY-OVERHOLT
135 mm



02-3751 - 02-3752
BABY-MIXTER

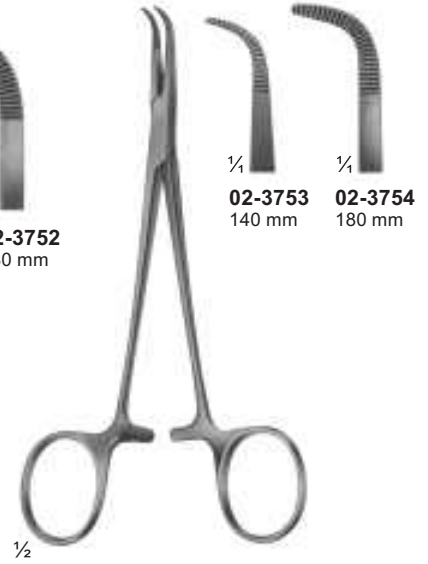

02-3753 - 02-3754
BABY-ADSON



02-3755
NISSEN



02-3756 - 02-3757
YASARGIL
195 mm



02-3758
OVERHOLT-MIXTER

Dissecting- and Ligature Forceps



1/2

02-3759 - 02-3770
OVERHOLT-GEISSENDOERFER

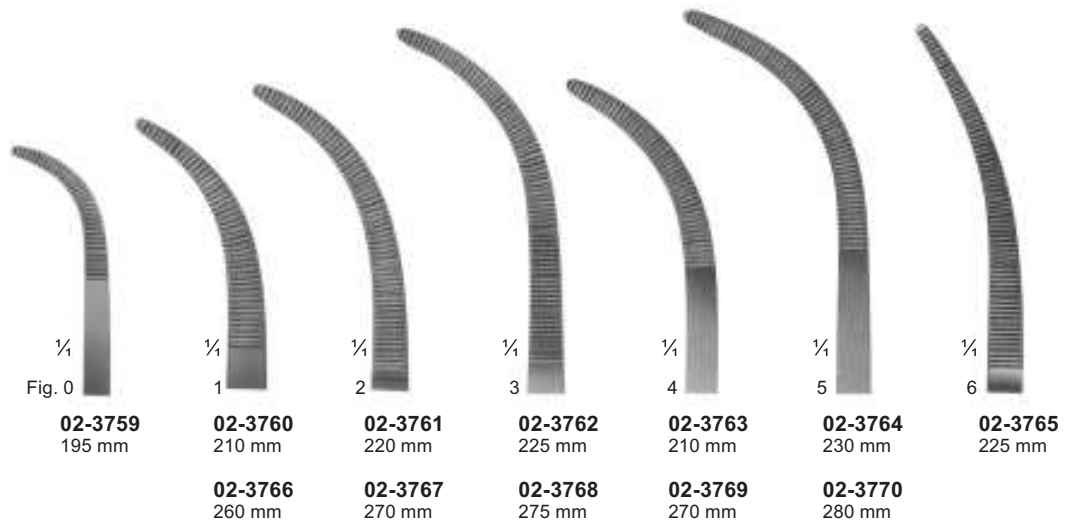

1/2

02-3771 - 02-3778
OVERHOLT
fine pattern

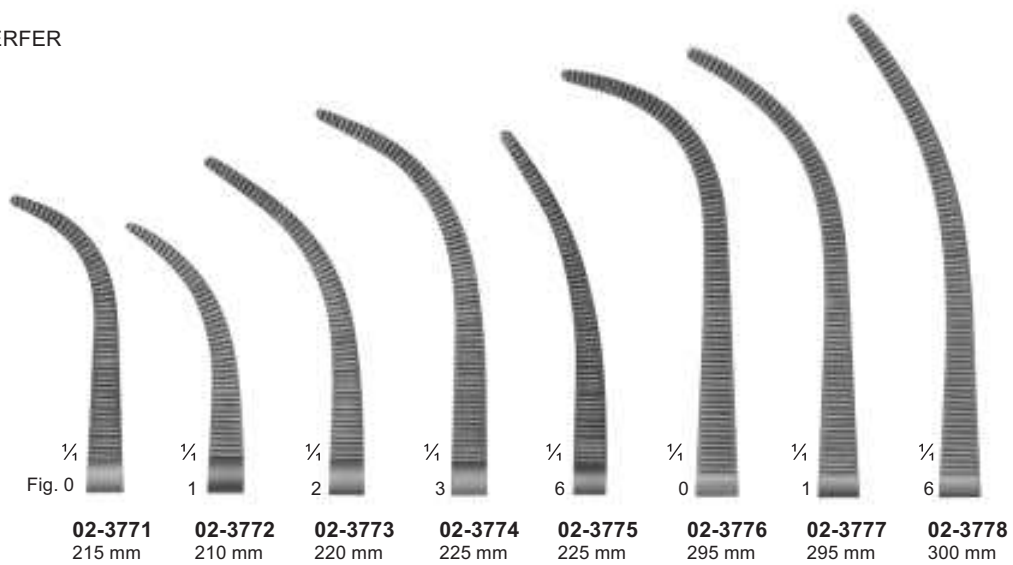

Dissecting- and Ligature Forceps

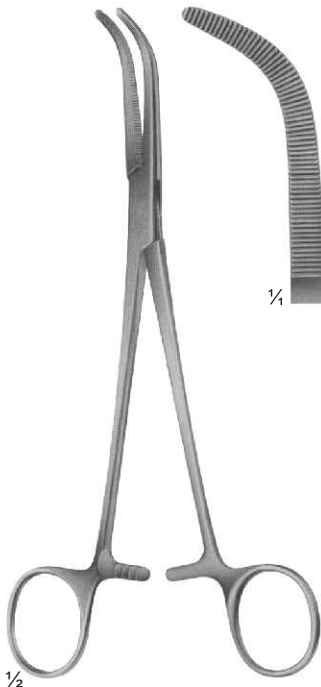

02-3779
MIXTER-O'SHAUGNESSY
190 mm

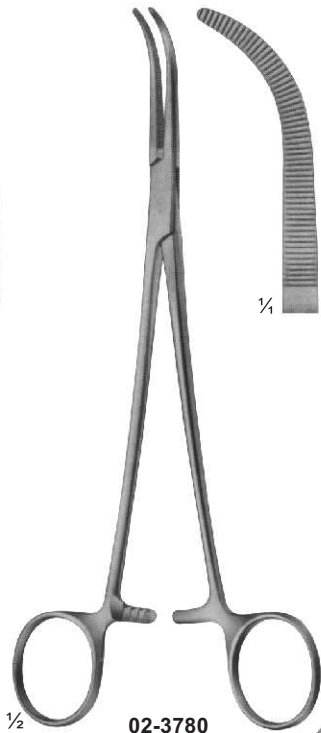

02-3780
HEISS
195 mm

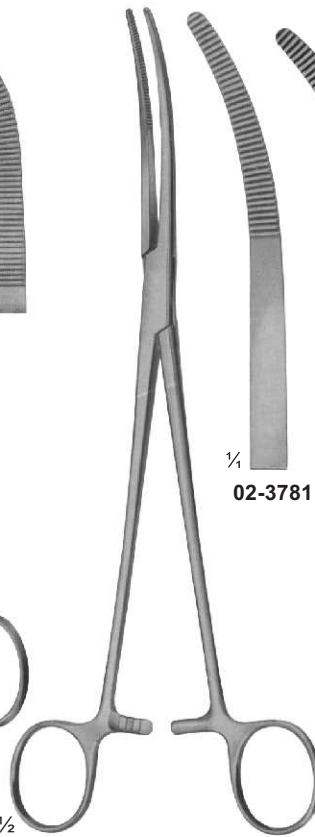

02-3781 - 02-3785
RUMEL
240 mm

02-3781 **02-3782** **02-3783** **02-3784** **02-3785**

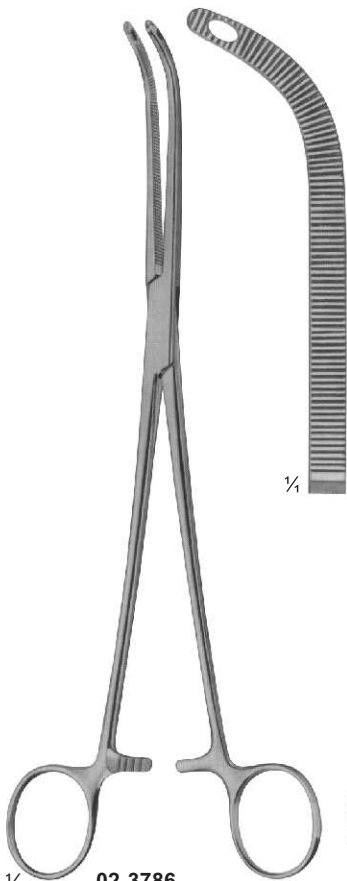

02-3786
FINOCHIETTO
245 mm

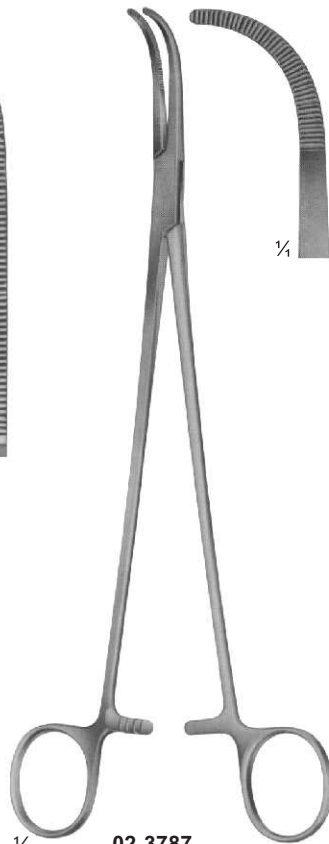

02-3787
MIXTER
230 mm



02-3788
LAWRENCE
270 mm

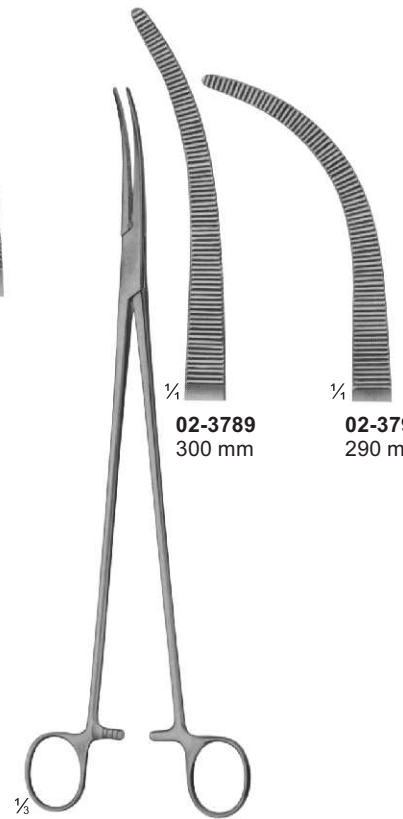

02-3789 - 02-3790
ZENKER

02-3789
300 mm

02-3790
290 mm

Dissecting- and Ligature Forceps



Peritoneum Forceps

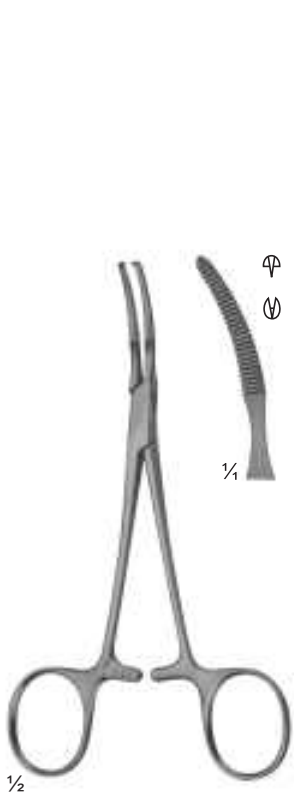

02-3799
BABY-MIKULICZ
140 mm

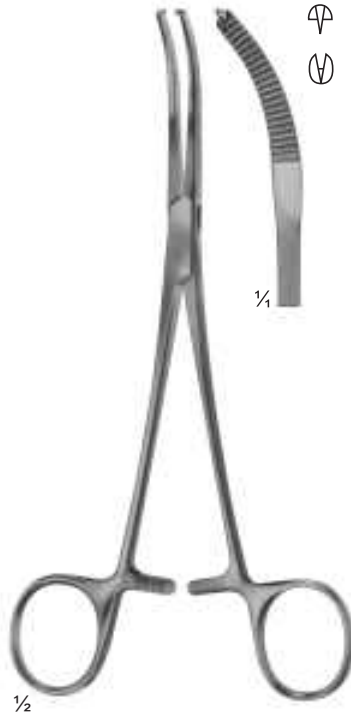

02-3800
MIKULICZ
185 mm

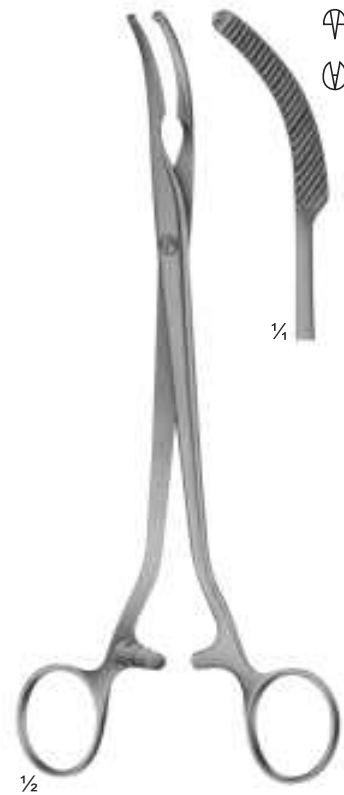

02-3801
MIKULICZ
205 mm

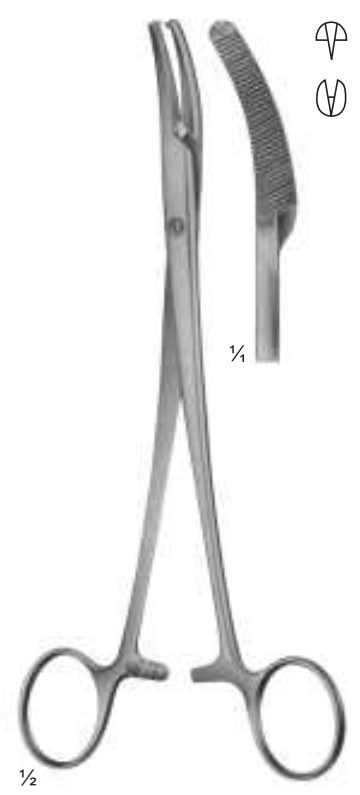

02-3802
MIKULICZ
200 mm

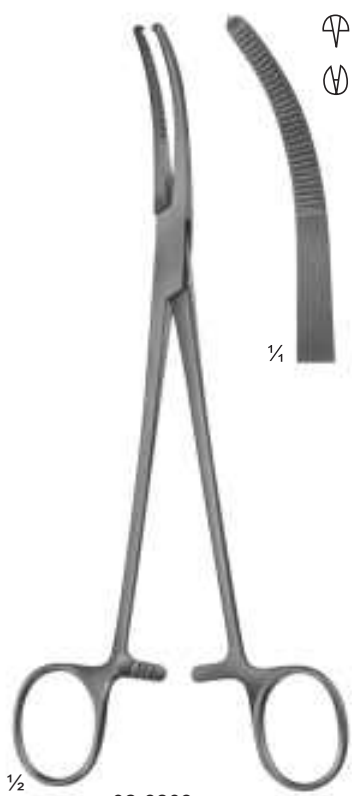

02-3803
MIKULICZ
205 mm

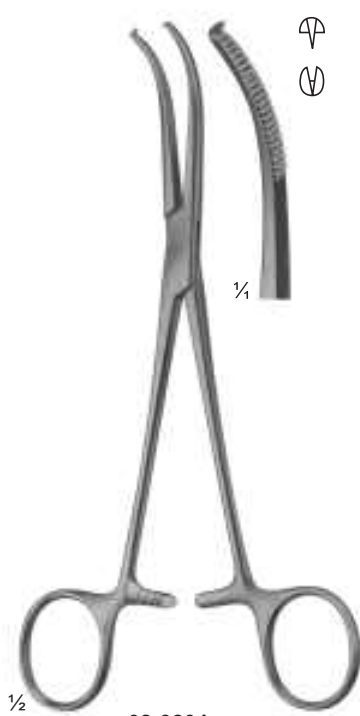

02-3804
MIKULICZ
185 mm

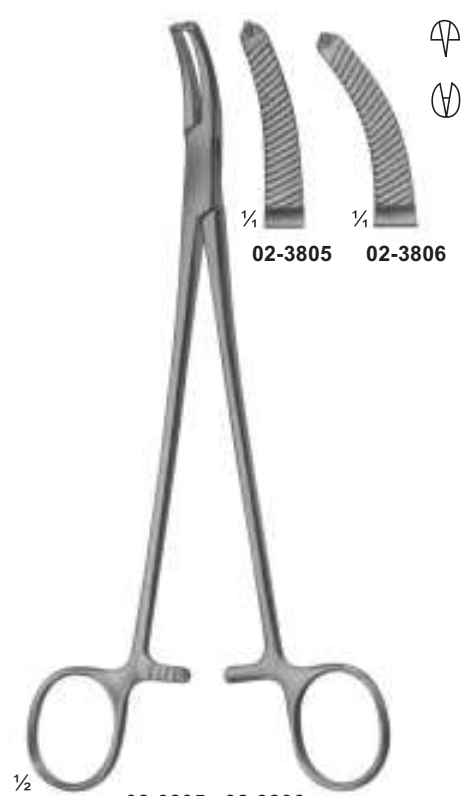

02-3805 - 02-3806
FAURE
205 mm

Hysterectomy and Haemostatic Forceps

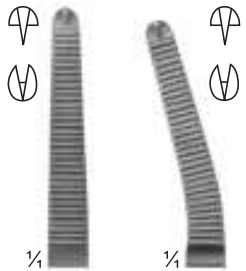

02-3807
210 mm

02-3808
205 mm

$\frac{1}{2}$ **02-3807 - 02-3808**
PHANEUF



$\frac{1}{4}$ **02-3809**
205 mm

$\frac{1}{4}$ **02-3810**
245 mm

$\frac{1}{2}$ **02-3809 - 02-3810**
HEANEY modif.

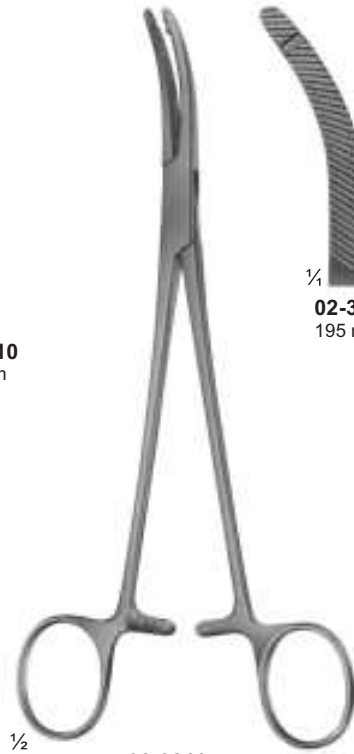

$\frac{1}{4}$ **02-3811**
195 mm

$\frac{1}{2}$ **02-3811**
HEANEY

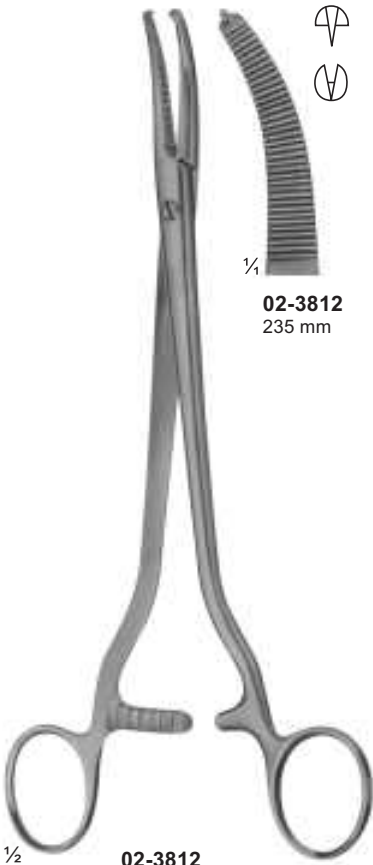

$\frac{1}{4}$ **02-3812**
235 mm

$\frac{1}{2}$ **02-3812**
WERTHEIM

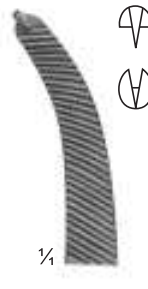
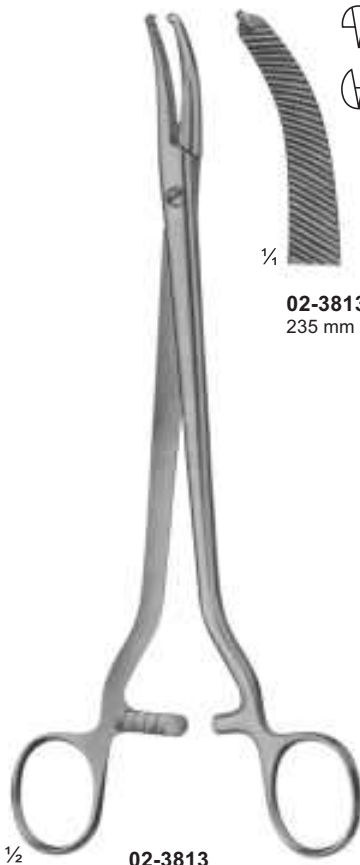

$\frac{1}{4}$ **02-3813**
235 mm

$\frac{1}{2}$ **02-3813**
WERTHEIM



$\frac{1}{4}$ **02-3814**
245 mm

$\frac{1}{2}$ **02-3814**
WERTHEIM

Atraumata Hysterectomy Forceps and Vaginal Clamps ATRAUMATA

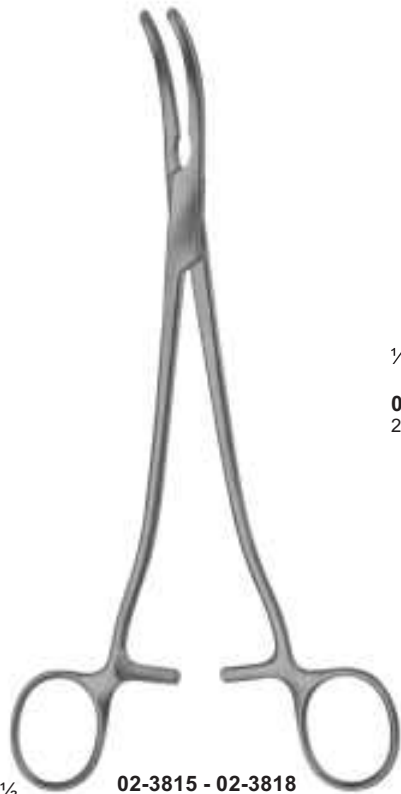

$\frac{1}{2}$ **02-3815 - 02-3818**
HEANEY



$\frac{1}{4}$ **02-3815**
225 mm



$\frac{1}{4}$ **02-3816**
220 mm



$\frac{1}{4}$ **02-3817**
215 mm



$\frac{1}{4}$ **02-3818**
205 mm



$\frac{1}{2}$ **02-3819 - 02-3822**
WERTHEIM
Parametrium clamps



$\frac{1}{4}$ **02-3819**
250 mm



$\frac{1}{4}$ **02-3820**
245 mm



$\frac{1}{4}$ **02-3821**
240 mm

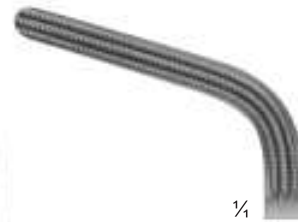

$\frac{1}{4}$ **02-3822**
220 mm

Hysterectomy Forceps and Vaginal Clamps and Compression Forceps ATRAUMATA



02-3823
WERTHEIM
Hysterectomy Forceps
255 mm

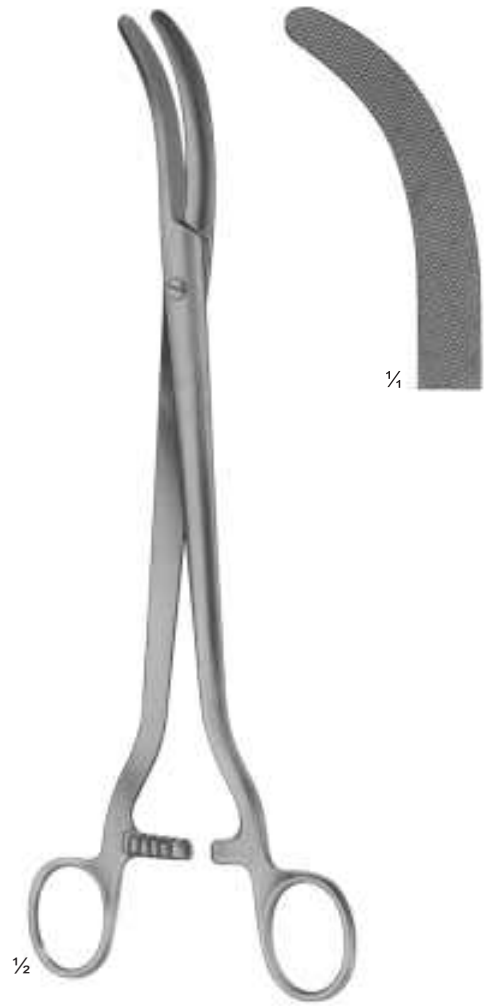

02-3824
WERTHEIM
Parametrium Clamp
260 mm



02-3825 - 02-3827
DICK



02-3825 255 mm
02-3826 265 mm
02-3827 275 mm

ATRAUMATA



02-3828
WERTHEIM
250 mm

1/2



1/4



02-3829
WERTHEIM-CULLEN
215 mm

1/2



1/4

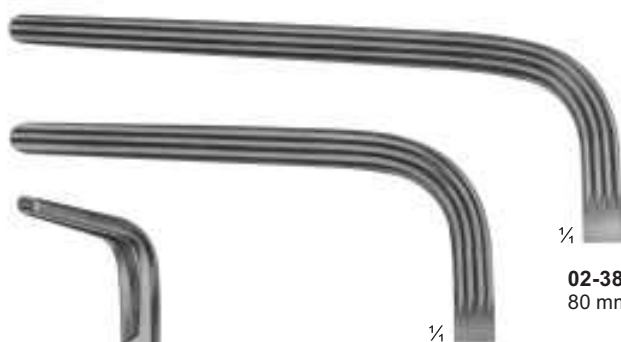

1/4

1/4

02-3830
60 mm

02-3831
80 mm



02-3830 - 02-3831
230 mm

1/2

Needle Holders For Micro Surgery



02-3832
ROHRSCHEIDER
With copper inserts
100 mm



02-3833
KALT
With catch
135 mm



02-3834
ARRUGA
With catch
135 mm



02-3835 - 02-3836
CASTROVIEJO
With catch
145 mm



02-3837 - 02-3838
CASTROVIEJO
With Catch
160 mm



02-3839 - 02-3840
Without catch
185 mm



02-3841 - 02-3842
JACOBSON
185 mm









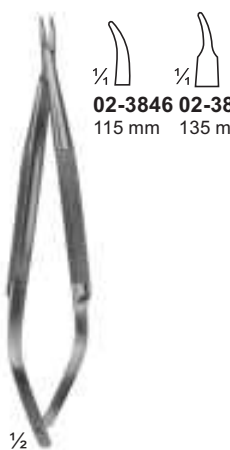

02-3843
Without catch
195 mm



02-3844 - 02-3845
YASARGIL
With catch
200 mm

Micro Needle Holders With Round Handle and Bayonet - Shaped

 <p> $\frac{1}{4}$ $\frac{1}{4}$ 02-3846 02-3847 115 mm 135 mm </p>	 <p> $\frac{1}{4}$ $\frac{1}{4}$ 02-3848 02-3849 </p>	 <p> $\frac{1}{4}$ $\frac{1}{4}$ 02-3850 02-3851 </p>	 <p> $\frac{1}{4}$ $\frac{1}{4}$ 02-3852 02-3853 </p>	 <p> $\frac{1}{4}$ </p>
<p> 02-3846 - 02-3847 BARRAQUER Without catch </p>	<p> 02-3848 - 02-3849 BARRAQUER Without catch 120 mm </p>	<p> 02-3850 - 02-3851 BARRAQUER With catch 120 mm </p>	<p> 02-3852 - 02-3853 With Catch 150 mm </p>	<p> 02-3854 MULLER With Locking Mechanism 145 mm </p>
 <p> $\frac{1}{4}$ $\frac{1}{4}$ 02-3855 02-3856 </p>	 <p> $\frac{1}{4}$ $\frac{1}{4}$ 02-3857 02-3858 </p>	 <p> $\frac{1}{4}$ $\frac{1}{4}$ 02-3859 02-3860 </p>	 <p> $\frac{1}{4}$ </p>	
<p> 02-3855 - 02-3856 BROCK Without catch 150 mm </p>	<p> 02-3857 - 02-3858 YASARGIL 200 mm </p>	<p> 02-3859 - 02-3860 YASARGIL 225 mm </p>	<p> 02-3861 YASARGIL 245 mm </p>	

Needle Holders

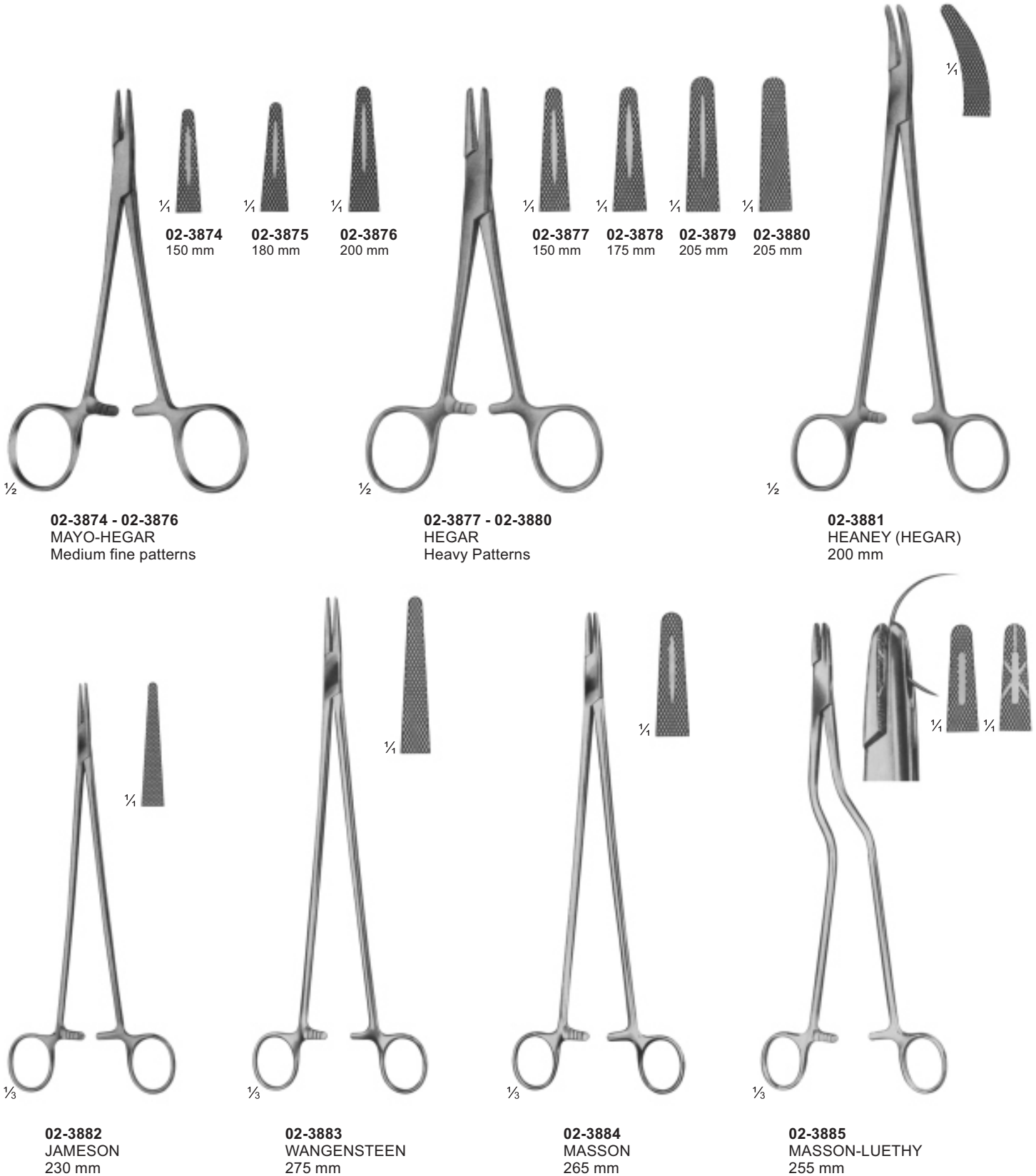

Needle Holders

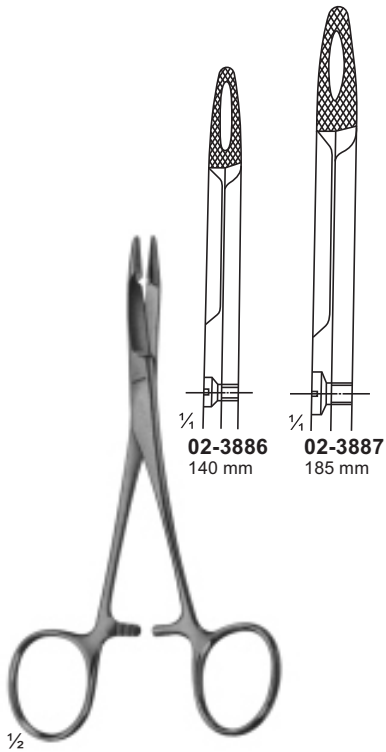

02-3886 - 02-3887
HEGAR-OLSEN
Needle Holders with Scissors

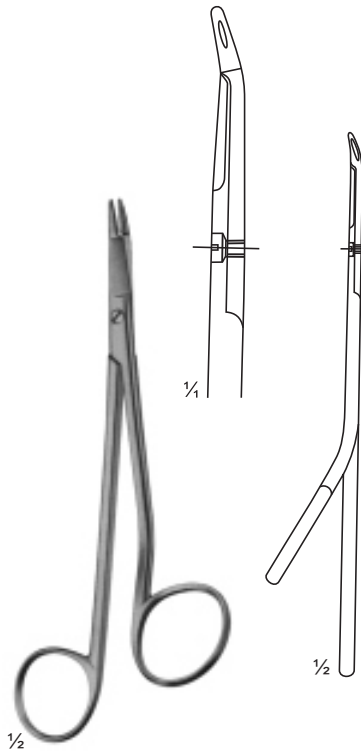

02-3888
GILLIES
Needle Holders with Scissors
150 mm

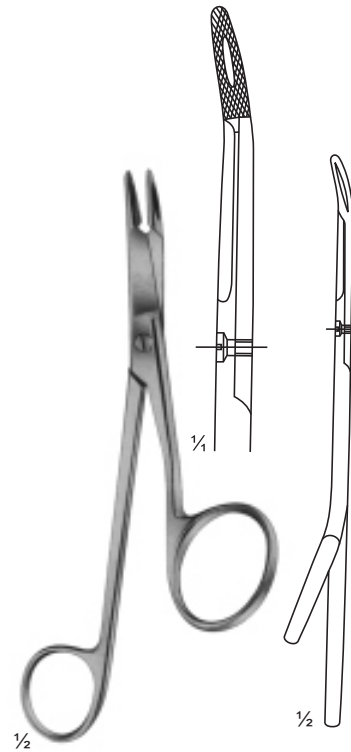

02-3889
GILLIES
Needle Holders with Scissors
160 mm

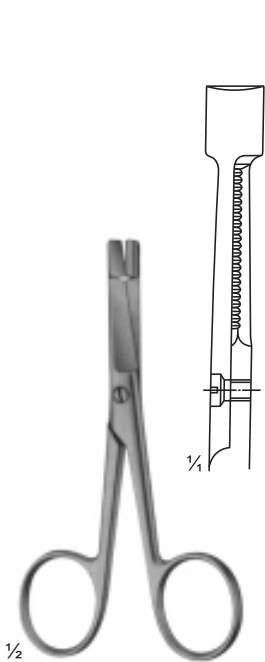

02-3890
EISELSBERG
Needle Holders with Scissors
115 mm

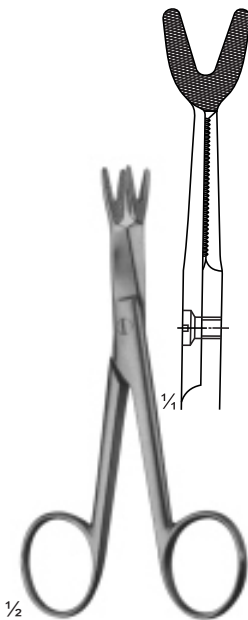

02-3891
SCHOEMAKER-LOTH
Needle Holders with Scissors
125 mm



02-3892
CRILE
150 mm



02-3893
TOENNIS
Elastic pattern for
dura-or intestinal suture
180 mm

Needle Holders

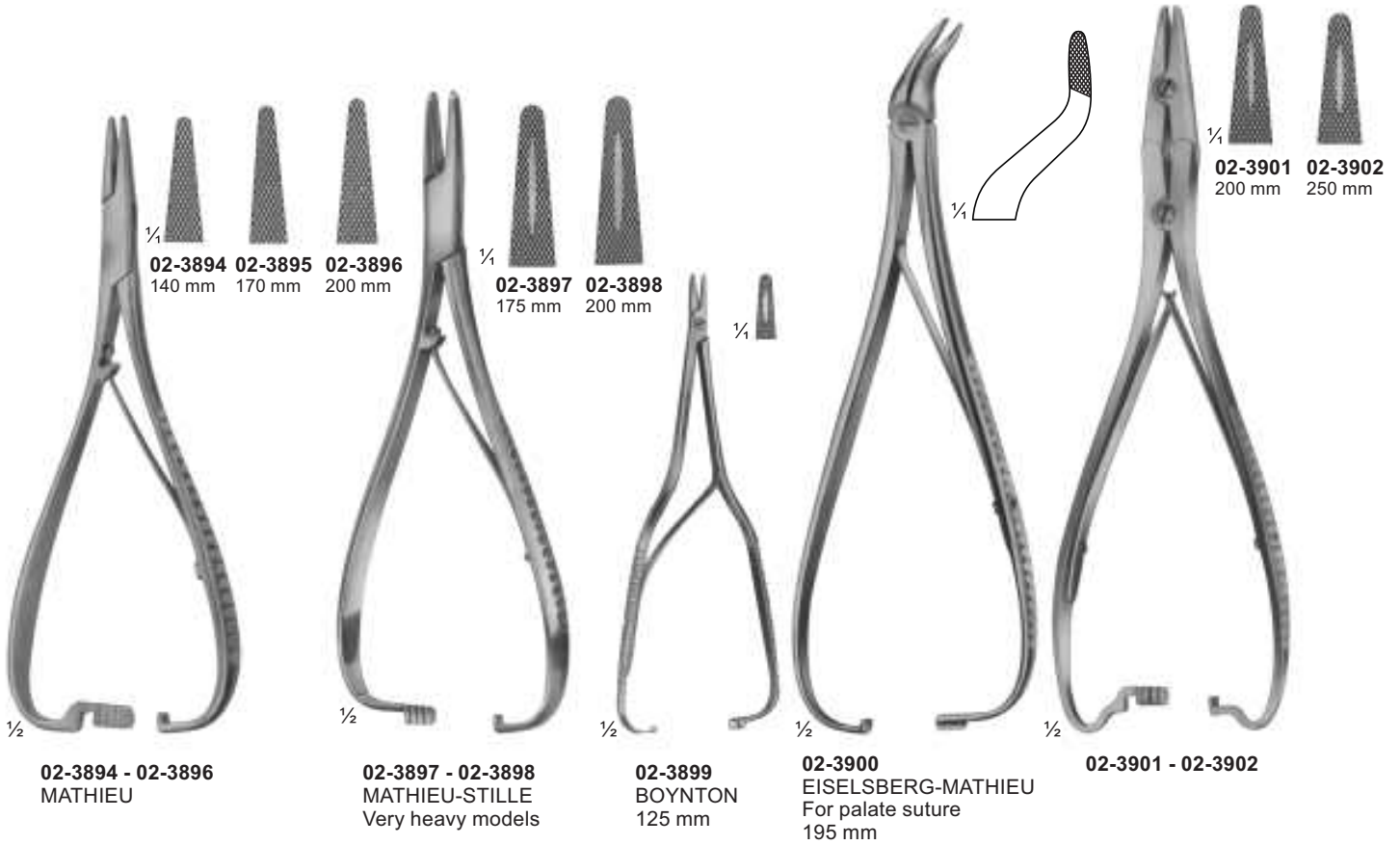

Spare Needles

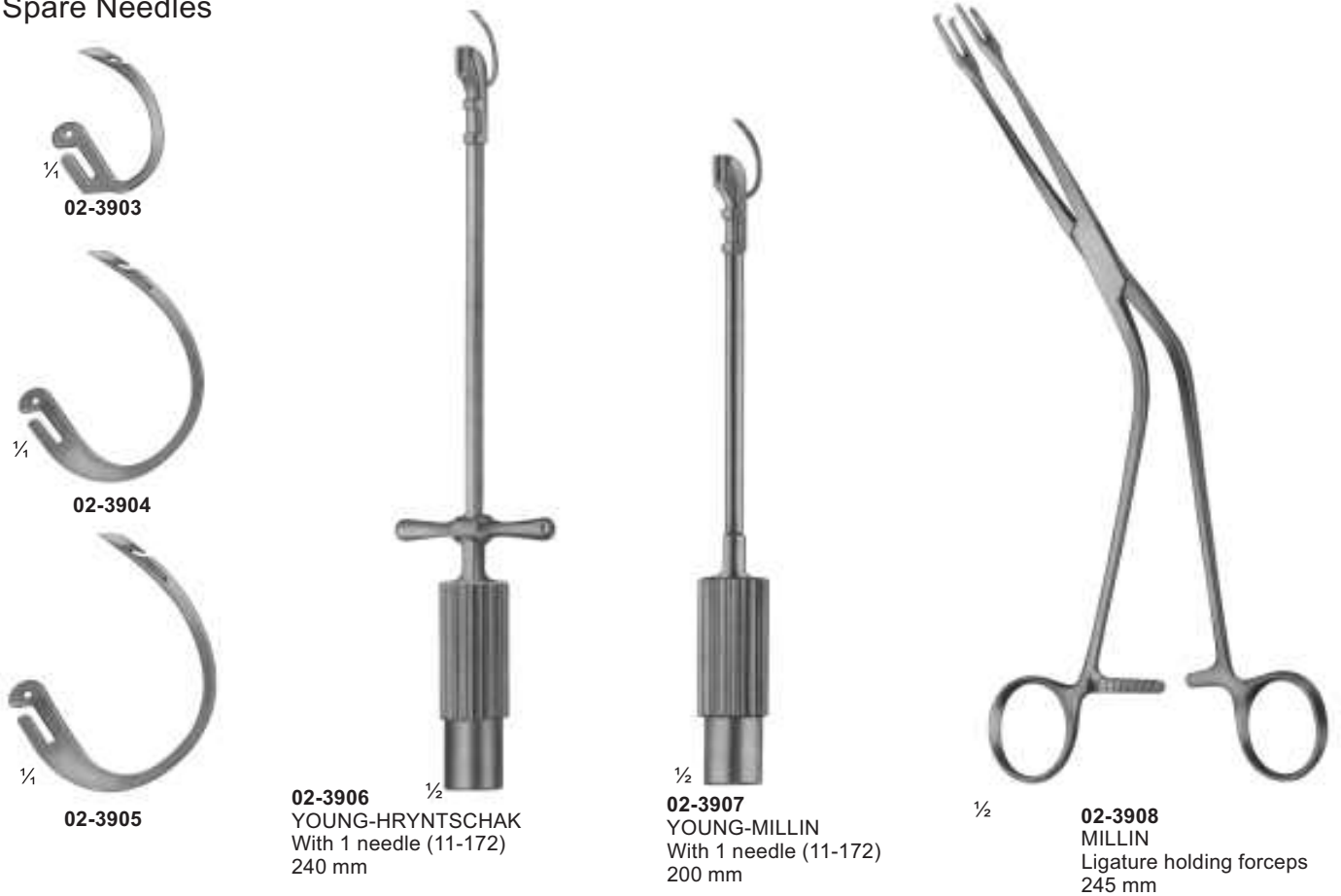

Suture Instruments - Reverdin Needles

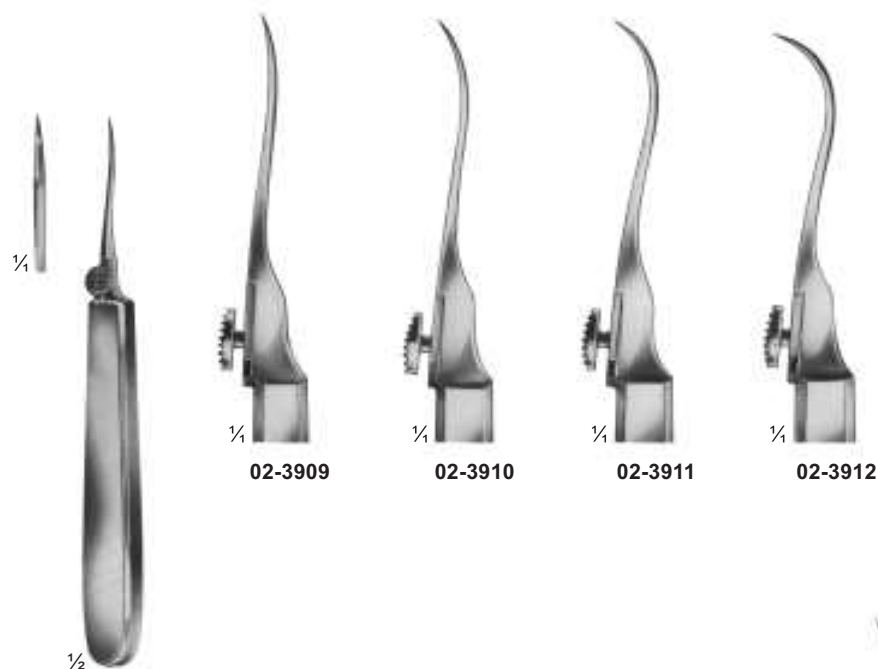

02-3909 02-3910 02-3911 02-3912

02-3909 - 02-3912
REVERDIN
140 mm

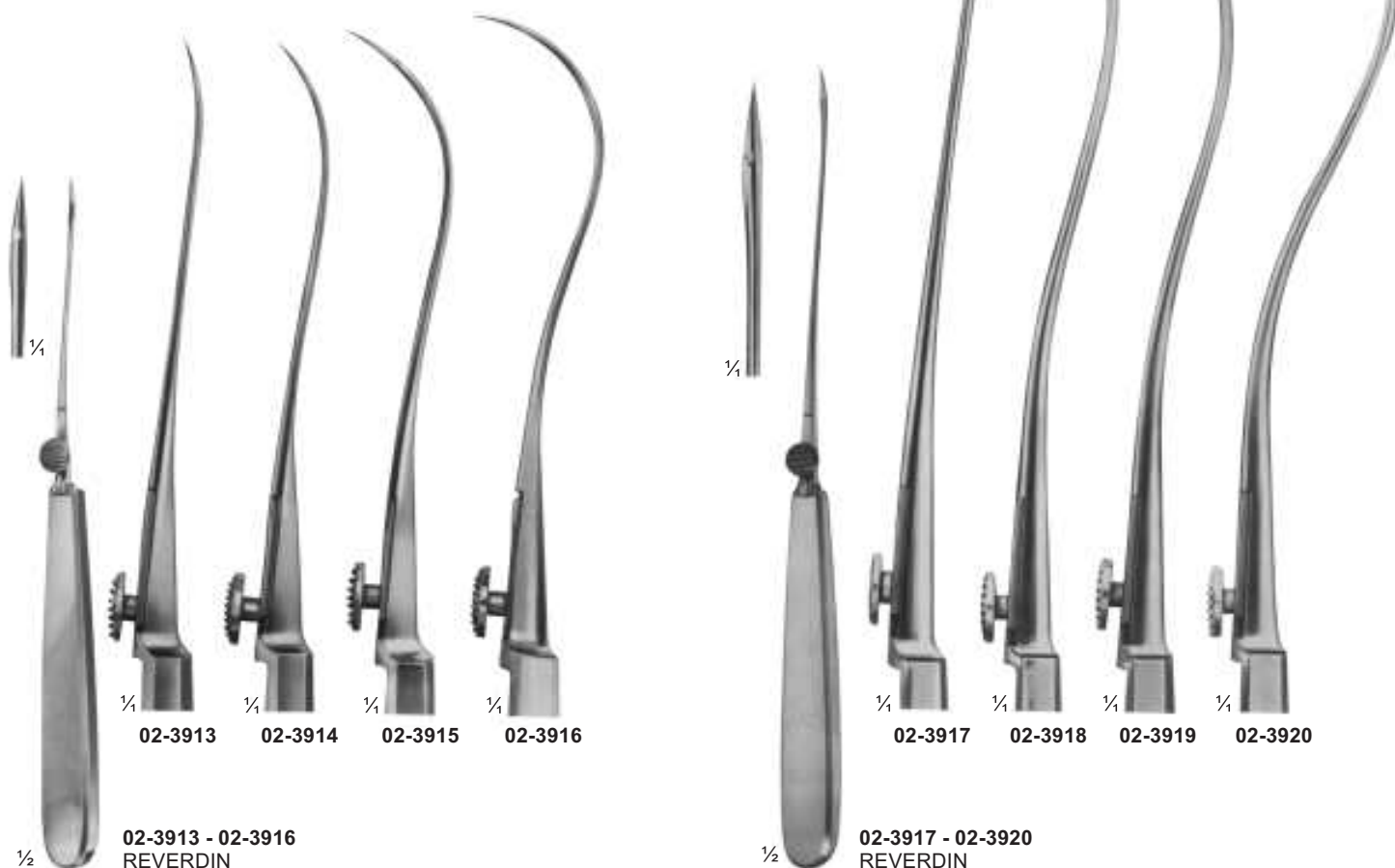

02-3913 02-3914 02-3915 02-3916

02-3917 02-3918 02-3919 02-3920

02-3913 - 02-3916
REVERDIN
195 mm

02-3917 - 02-3920
REVERDIN
220 mm

Suture Instruments - Ligature Needles

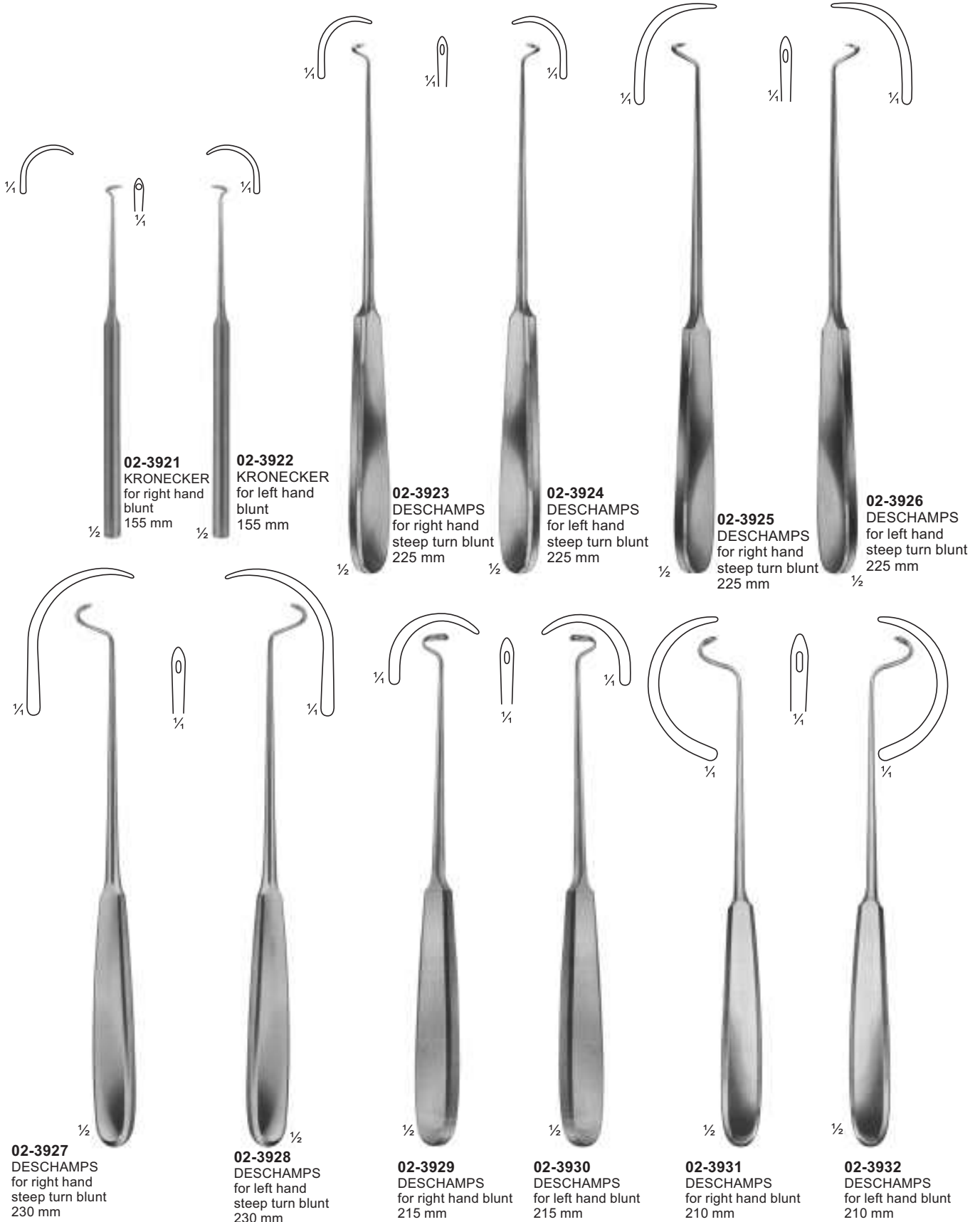

02-3921
KRONECKER
for right hand
blunt
155 mm

02-3922
KRONECKER
for left hand
blunt
155 mm

02-3923
DESCHAMPS
for right hand
steep turn blunt
225 mm

02-3924
DESCHAMPS
for left hand
steep turn blunt
225 mm

02-3925
DESCHAMPS
for right hand
steep turn blunt
225 mm

02-3926
DESCHAMPS
for left hand
steep turn blunt
225 mm

02-3927
DESCHAMPS
for right hand
steep turn blunt
230 mm

02-3928
DESCHAMPS
for left hand
steep turn blunt
230 mm

02-3929
DESCHAMPS
for right hand blunt
215 mm

02-3930
DESCHAMPS
for left hand blunt
215 mm

02-3931
DESCHAMPS
for right hand blunt
210 mm

02-3932
DESCHAMPS
for left hand blunt
210 mm

Suture Instruments - Ligature Needles



1/2
02-3933
HURD
for right hand
sharp
210 mm



1/2
02-3934
HURD
for left hand
sharp
210 mm



1/2
02-3935
DESCHAMPS
for right hand
sharp
215 mm



1/2
02-3936
DESCHAMPS
for left hand
sharp
215 mm



1/2
02-3937
JONESCO
Needle for wire suture
185 mm



1/2
02-3938
CLAUS VAN EICKEN
Needle for wire suture
250 mm

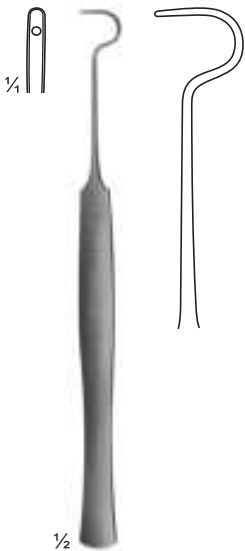

1/2
02-3939
150 mm

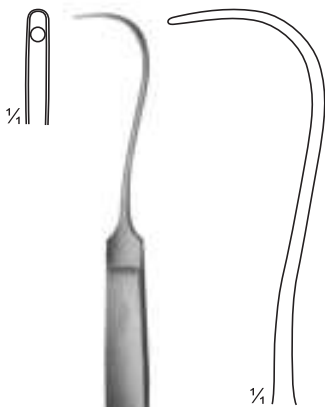

1/2
02-3940
SYME
170 mm

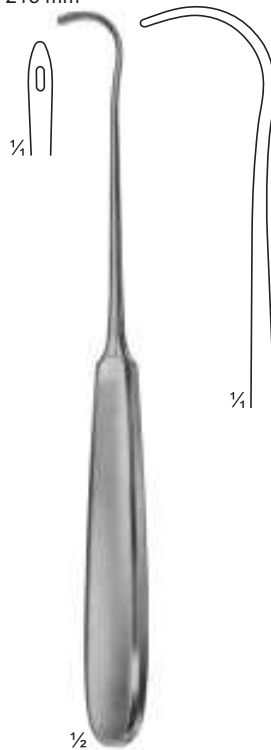

1/2
02-3941
COOPER
205 mm

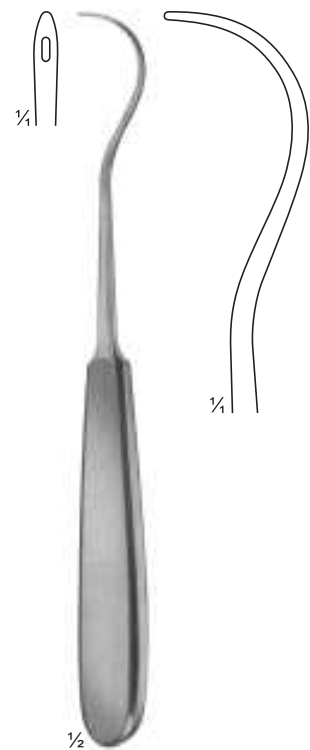

1/2
02-3942
KOCHER
205 mm

Ligature Needles

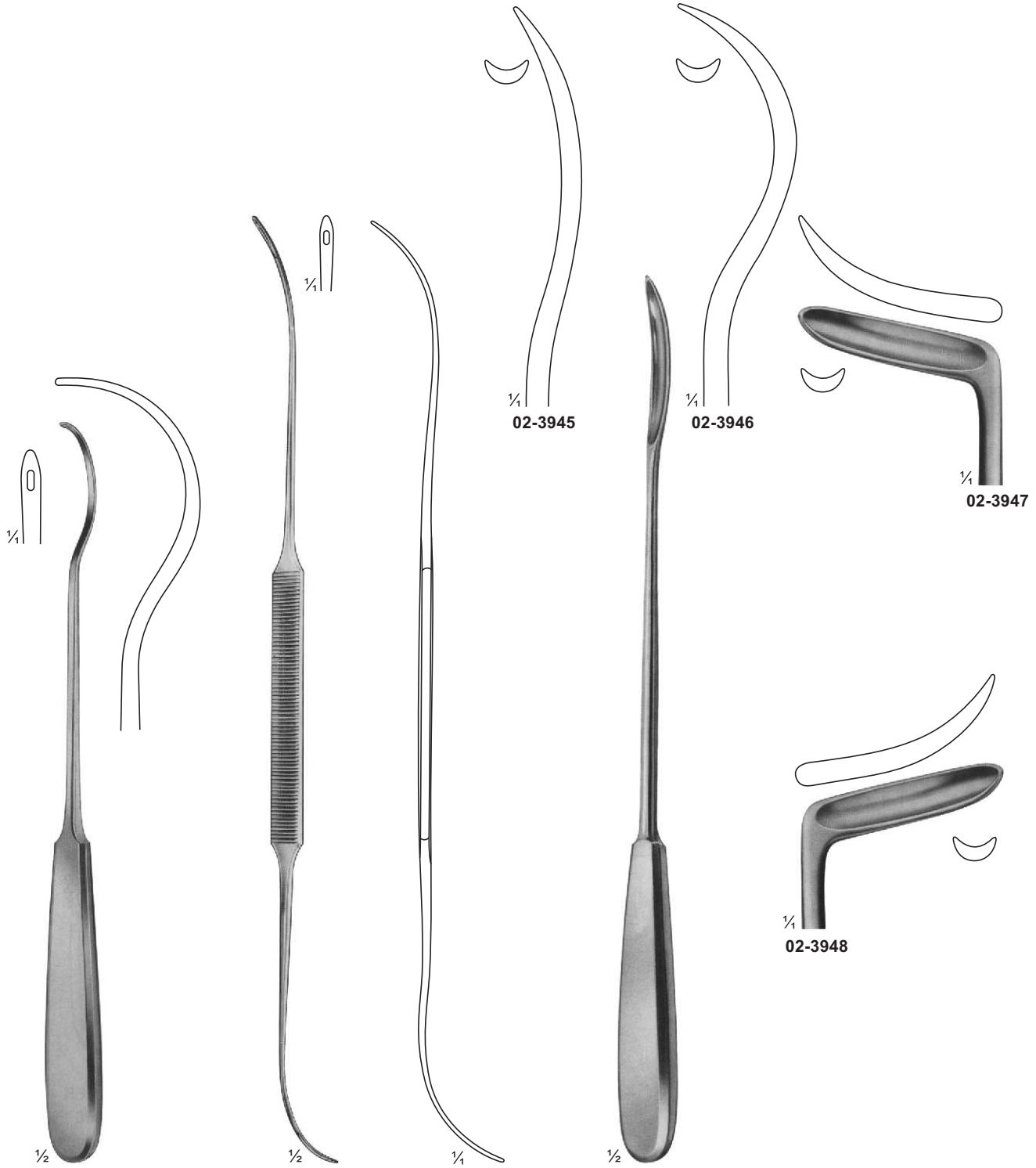

02-3943
BRUNNER
240 mm

02-3944
SCHMIEDEN-DICK
Malleable / Flexible
320 mm

02-3945 - 02-3946
BRUNNER
Guiding Probes
300 mm

Guiding Probes and Suture Instruments

4.5 mm

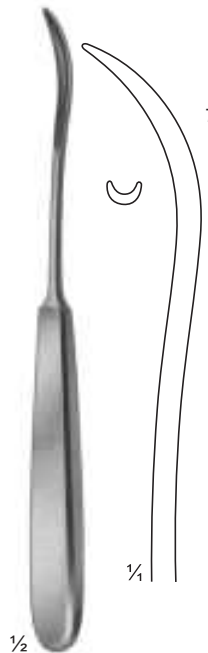

02-3949
KOENIG
195 mm

7 mm



02-3950
KOENIG
200 mm

8 mm

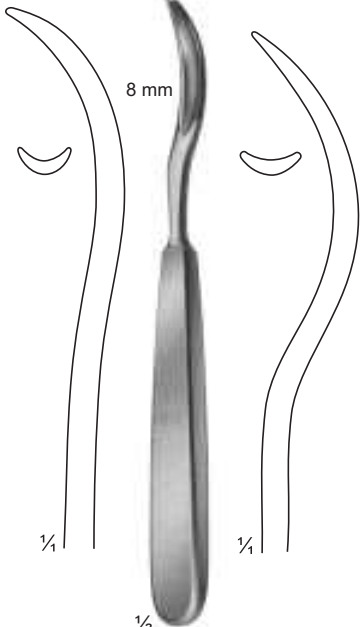

02-3951
SCHMIEDEN
185 mm

11 mm

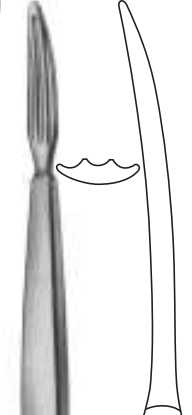

02-3952
KOCHER
150 mm

12 mm



02-3953
KOCHER
170 mm

5 mm

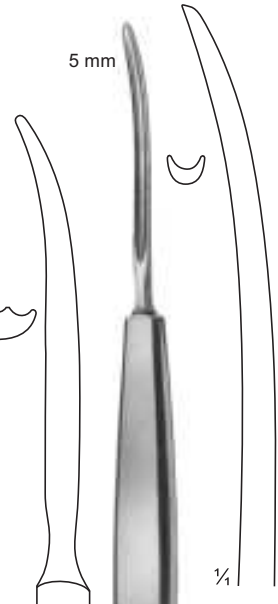

02-3954
PAYR
195 mm

5 mm

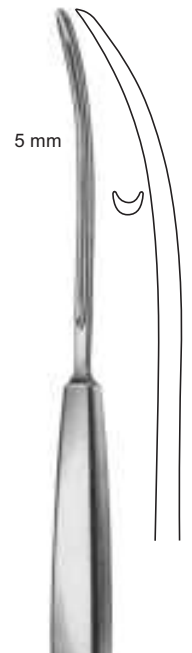

02-3955
PAYR 225 mm

4 mm

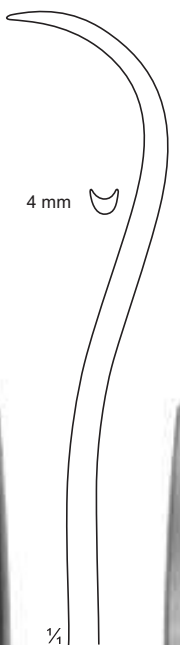

02-3956
280 mm

4.5 mm

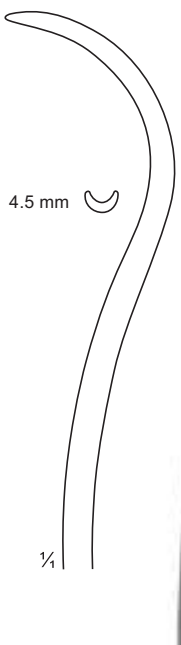

02-3957
KIRSCHNER
255 mm

8 mm

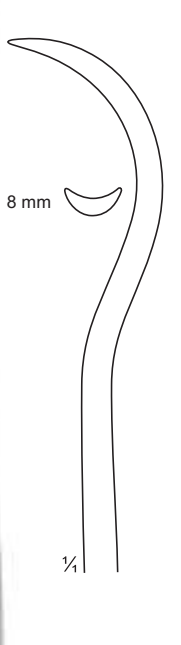

02-3958
BRUNNER
245 mm

02-3959
Knot tier and
ligature Adjuster
230 mm



02-3960
CASPAR
Knot tier and
ligature Adjuster
230 mm



02-3961
WIENER MODELL
Suture hook
235 mm



Directors and Probes

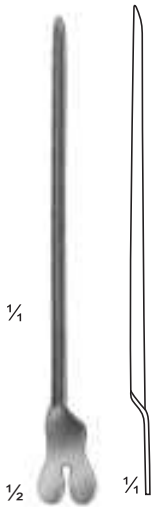

02-3962 - 02-3964
02-3962 130 mm
02-3963 145 mm
02-3964 160 mm
 Directors

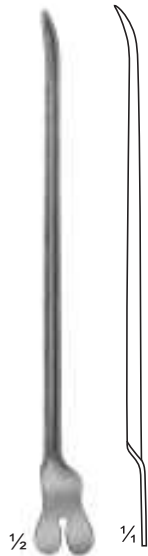

02-3965
DOYEN
 145 mm
 Directors

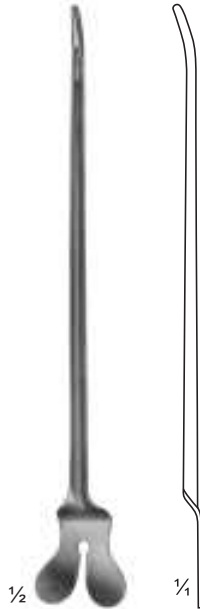

02-3966
NELATON
 160 mm
 Directors

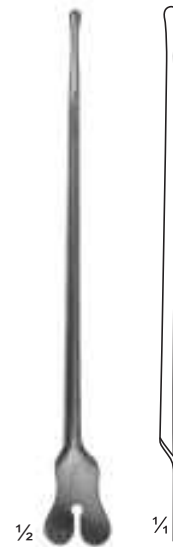

02-3967
 Director with tip
 Diam. Of tip 3,3 mm
 140 mm

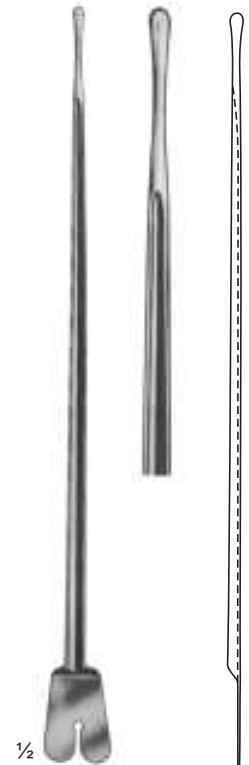

02-3968
BRODIE
 Director with tip,
 Diam. Of tip 3,5 mm
 200 mm

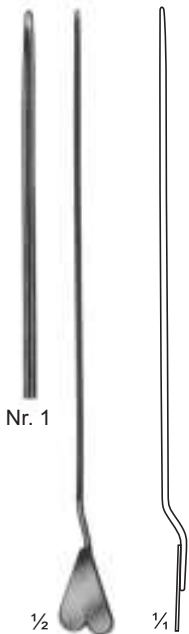

02-3969
LOCKHART-MUMMERY
 165 mm
 Straight

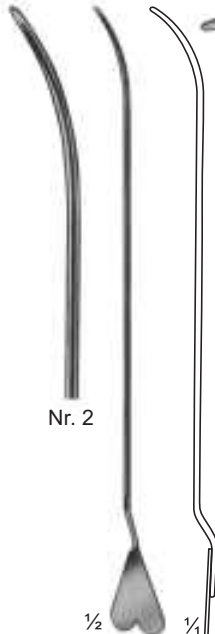

02-3970
LOCKHART-MUMMERY
 165 mm
 45° Curved

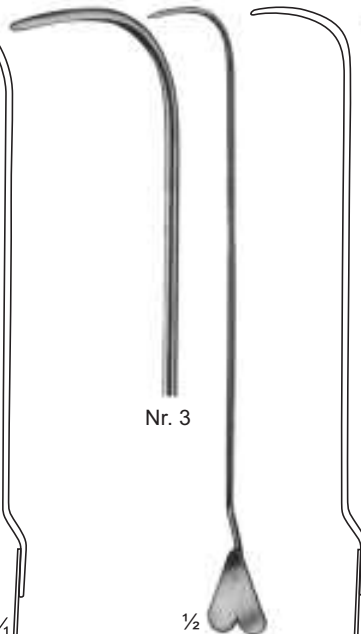

02-3971
LOCKHART-MUMMERY
 165 mm
 90° Curved

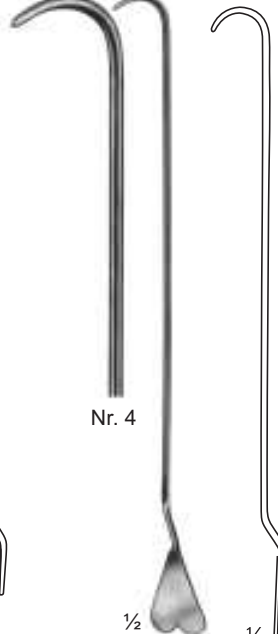

02-3972
LOCKHART-MUMMERY
 165 mm
 Retrograde Curved



02-3973
 Director with wire
 loop, malleable
 190 mm

Probes



02-3974
2,5 mm Ø
02-3975
2,5 mm Ø
02-3976
3,0 mm Ø

1/2

02-3974 - 02-3976
02-3974 145 mm
02-3975 160 mm
02-3976 200 mm
Probes with eye



1,5 mm Ø

1/2

02-3977
Myrtle leaf probe
145 mm



2,0 mm Ø

1/2

02-3978 - 02-3982
Myrtle leaf probe
02-3978 130 mm
02-3979 145 mm
02-3980 160 mm
02-3981 180 mm
02-3982 200 mm



1/2

02-3983
Probes

diam. of tips			Length
1 mm	1.5 mm	2 mm	
-	02-3984	-	130mm
02-3985	02-3986	02-3991	145mm
-	02-3987	02-3992	160mm
-	02-3988	02-3993	180mm
-	02-3989	02-3994	200mm
-	02-3990	-	250mm
-	-	02-3995	300mm



1/2

02-3996
Double ended probe,
malleable, diam. of tips
3 mm with hole
190 mm



02-3997
250mm 300mm
Double ended probes,
tin, malleable, diam. of tips
3,5 mm with hole



1/4

02-3998
Double ended probe,
tin, malleable,
diam. of tips 4 mm
400 mm



1/3

Ø tip
02-3999 - 02-4001
02-3999 1,5 mm
02-4000 2,0 mm
02-4001 2,5 mm
300 mm Probes

Probes - Spatulas - Cotton Applicators



German Silver

02-4002
 STACKE
 Silver
 100 mm
 Ø 0.8mm

02-4003
 KILLIAN
 165 mm
 Ø 1.5mm

02-4004
 160 mm
 Ø 1.4mm

02-4005
 SEIFFERT
 Silver
 180 mm
 Ø 0.5mm

02-4006
 BOWMAN
 130 mm

- 02-4007 - 02-4011**
- 02-4007** 0.7+0.8mmØ Fig. 00/0
 - 02-4008** 0.9+1.1mmØ Fig. ½
 - 02-4009** 1.3+1.4mmØ Fig. ¾
 - 02-4010** 1.5+1.6mmØ Fig. 5/6
 - 02-4011** 1.8+1.9mmØ Fig. 7/8

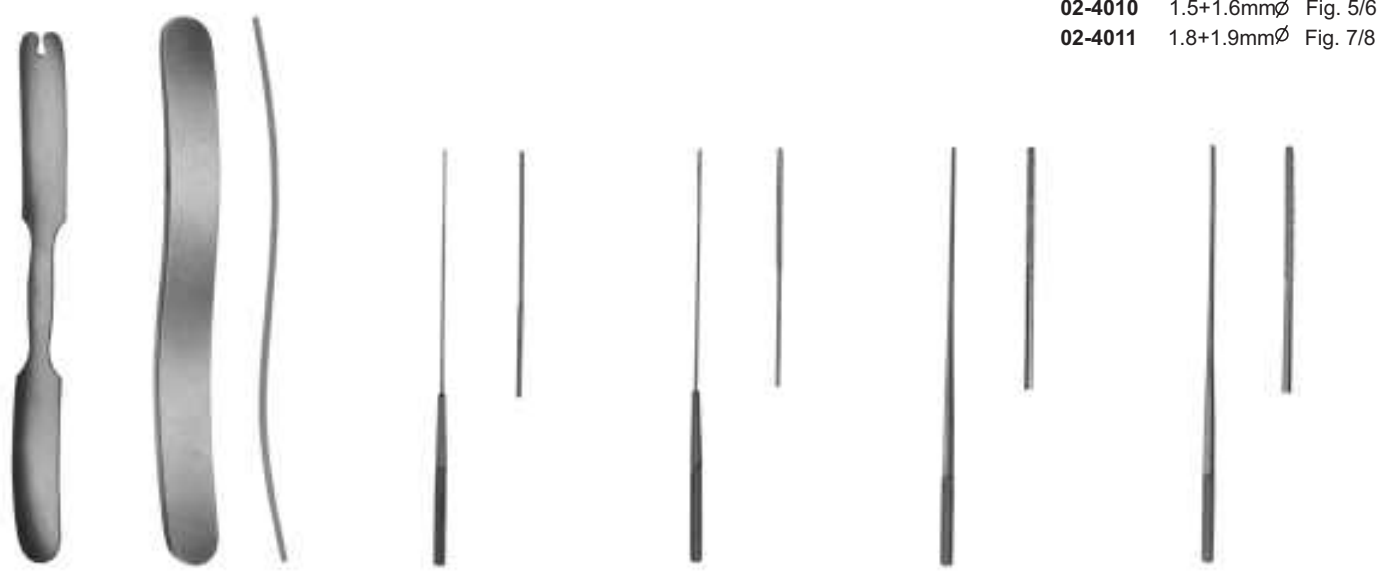

02-4012
 SPATULA
 145 mm

02-4013
 SPATULA
 145 mm

02-4014
 Modell PICCOLO
 Round Serrated end
 110 mm 0.7mm

02-4015
 Modell PICCOLO
 Triangular Serrated end
 110 mm 0.7mm

02-4016
 FARRELL
 Round Serrated end
 110 mm 1.2mm

02-4017
 LATHBURY-FARRELL
 Triangular Serrated end
 110 mm 1.4mm

Cotton Applicators

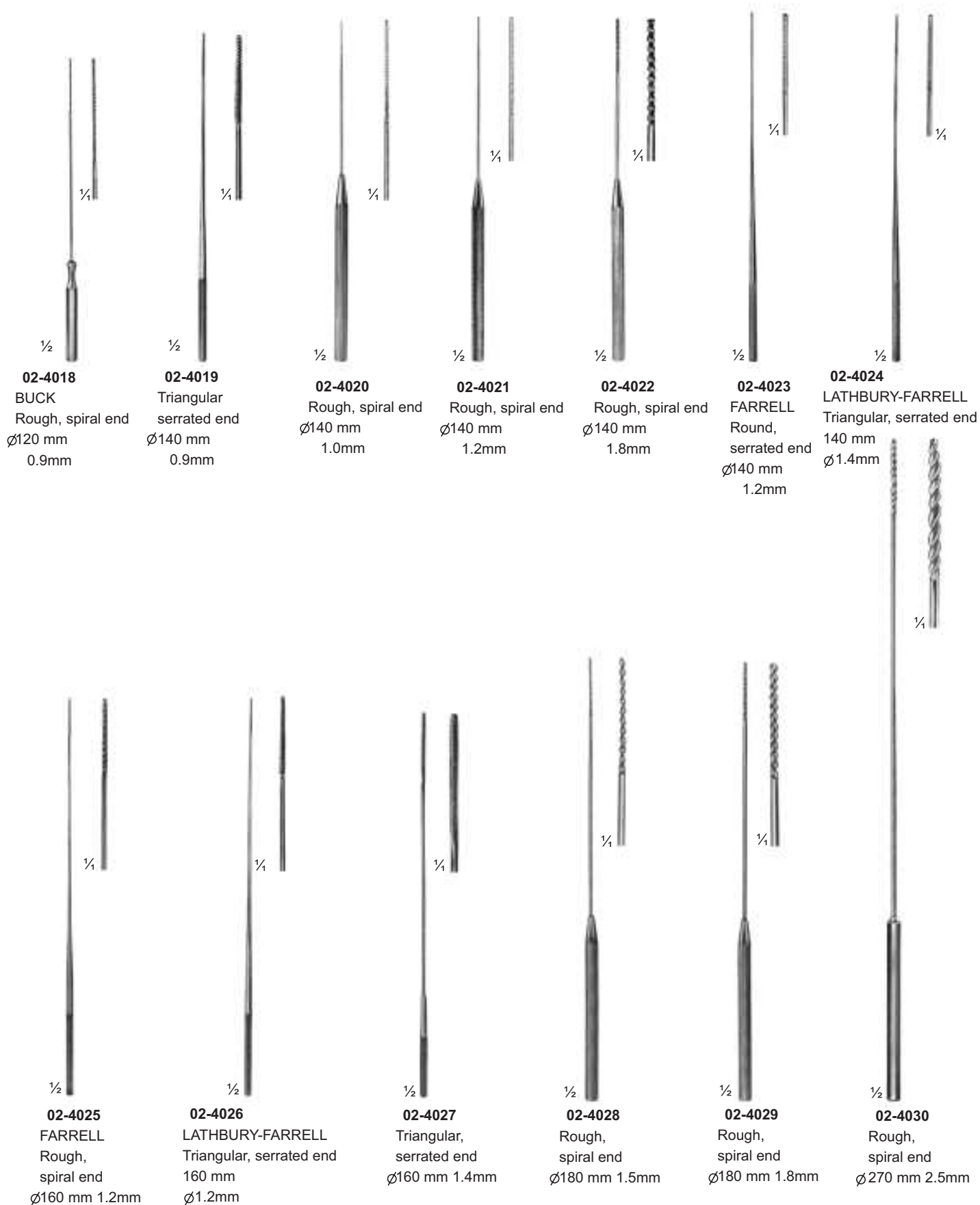

Clip Applying Forceps, Clip Applying - and Removing Forceps



1/2

02-4031
MICHEL
125 mm



1/2

02-4032
HEGENBARTH
120 mm



1/2

02-4033
WACHENFELDT
120 mm



1/2

02-4034
WACHENFELDT
120 mm



1/2

02-4035
MICHEL
125 mm



1/2

02-4036
MICHEL modif.
130 mm



1/2

02-4037
HEATH
135 mm



1/2

02-4038
COLLIN
135 mm

Suturing Instrument Set, Pocket Instrument Set



02-4039

- Suturing instruments set, in metal case consisting of:
- 1 michel clip applying and removing forceps,
 - 1 Scissors, curved, sharp/sharp, 115mm
 - 25 MICHEL clips, 16 x 3mm
 - 1 Delicate tissue forceps, 130mm
 - 1 Scalpel, bellied
 - 1 MATHIEU needle holder, 140mm
 - 1 Perforated metal case, stainless containing:
 - 1 Suture needle
 - 1 Suture needle
 - 1 Suture needle



02-4040

Pocket instrument set, in metal case consisting of:

Bottom tray

- 1 MATHIEU needle holder, 140mm
- 1 MICHEL clip forceps, combined
- 1 Myrtle leaf probe, 130mm
- 1 Sharp double curette
- 1 Skin hook
- 1 Detachable scalpel handle, no.4
- 1 Perforated metal case, containing
- 6 Scalpel blades
- 1 Perforated metal case, stainless, containing
- 1 Suture needle
- 1 Suture needle
- 1 Suture needle

Top tray

- 1 Tissue forceps, 130mm
- 1 KOCHER haemostatic forceps, 130mm
- 1 Straight surgical scissors, 130mm
- 1 Dissecting forceps, 130mm
- 1 FEILCHENFELD splinter forceps, 115mm
- 25 MICHEL clip, 16 x 3mm
- 1 Flacon of suture skin, sterile in alcohol



02-4041

Pocket instrument set, in metal case consisting of:

Bottom tray

- 1 MAYO-HEGER needle holder, 150mm
- 1 MICHEL clip forceps, combined
- 1 Myrtle leaf probe, 130mm
- 1 Sharp double curette
- 1 Skin hook
- 1 Detachable scalpel handle, no. 4
- 1 Perforated metal case, consisting
- 6 Scalpel blades
- 1 Perforated metal case, stainless, consisting:
- 1 Suture needle
- 1 Suture needle
- 1 Suture needle

Top tray

- 1 Tissue forceps, 130mm
- 1 CRILE haemostatic forceps, 140mm
- 1 Straight surgical scissors, 130mm
- 1 Dissecting forceps, 130mm
- 1 FEILCHENFELD splinter forceps, 115mm
- 25 MICHEL clip, 16 x 3mm
- 1 Flacon of suture silk, sterile in alcohol

Pocket Instrument Set, Venae Sectio Set

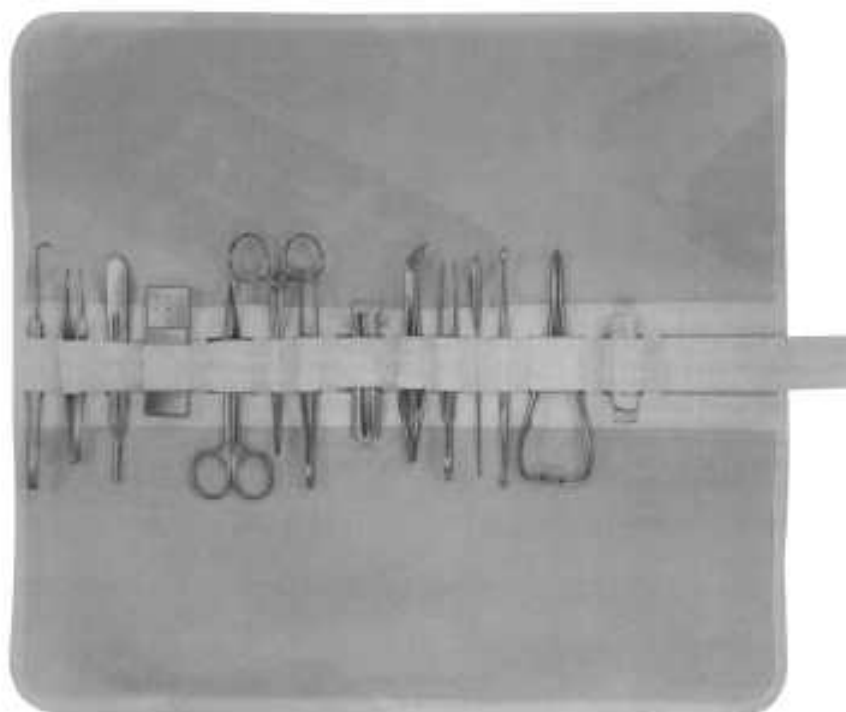

02-4042

Pocket instrument set in metal case 170 x 90mm canvas roll only, sterilizable in autoclave. consisting of:
 1 Myrtle leaf probe, 130mm
 1 Sharp double curette
 1 FEILCHENFELD splinter forceps, 115mm
 1 Dissecting forceps, 130mm 1 Tissue forceps, 130mm

1 Straight surgical scissors, 130mm
 1 Scalpel handle no. 4
 1 Perforated metal case, consisting
 6 scalpel blades
 1 KOCHER haemostatic forceps, 130mm
 1 Skin hook
 1 MATHIEU needle holder, 140mm
 1 Tube of suture skin, sterile in alcohol
 1 MICHEL clip forceps, 120mm



25 MICHEL clip, 16 x 3mm
 1 Perforated metal case, stainless, consisting:
 1 Suture needle
 1 Suture needle
 1 Suture needle

02-4043

Canvas roll only, sterilizable in autoclave

Suitable Metal Cases



02-4044

Venae sectio set, canvas roll only, sterilizable in autoclave. consisting of:
 2 Tissue forceps, 1 x 2 teeth, 140mm
 1 Dissecting forceps, 145mm
 1 FEILCHENFELD splinter forceps, 115mm
 1 Straight scissors, sharp, 110mm
 1 Curved scissors, blunt, 115mm
 3 HALSTED mosquito forceps, curved on flat, 125mm



250 x 125 x 55mm

233 x 148 x 57mm

1 DESCHAMPS needle, blunt, 210mm
 1 DOYEN Director, curved, 140mm
 2 Wound retractors, 4 blunt prongs, 160mm
 2 DESMARRES wound retractors, 135mm
 1 FINSEN retractors, 2 x3 blunt prongs, 80mm
 1 Scalpel handle no. 4
 4 Sterile scalpel blades, no 18, single peel pack
 1 Needle box, perforated, round, diam. 65mm
 1 HEGAR-MAYO DUROGRIP needle holder, 180mm

02-4045

Canvas roll only, sterilizable in autoclave



02-4046

Venae sectio set, in metal case

consisting of:

Bottom tray

- 1 MATHIEU needle holder, fine pattern 140mm
- 1 Ligature needle, fine short pattern
- 1 DOYEN director, curved
- 1 HEGENBARTH clip forceps,
- 1 ELSCHNIG tissue forceps, 1 x 2 teeth fine, 105mm
- 1 Dressing forceps, fine 105mm
- 1 Tissue forceps, 1 x 2 teeth, 110mm
- 1 Vessel scissors, straight, with 1 ball point, 110mm
- 1 Vessel scissors, curved, pointed 105mm
- 1 FINSSEN retractor
- 1 Perforated needle case

Top tray

- 1 Scalpel, pointed
- 1 Scalpel, bellied
- 2 HALSTED mosquito forceps, curved, 125mm
- 2 HALSTED mosquito forceps, straight, 1x 2 teeth, 125mm
- 3 BACKHAUS towel forceps, 90mm
- 2 Flacon holder

Nerve - and Vessel Hooks

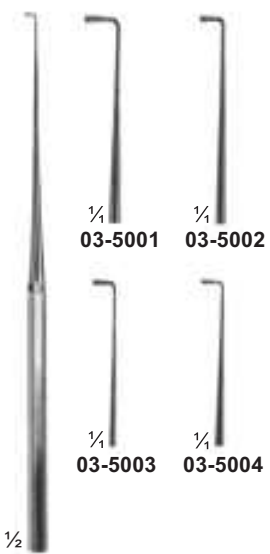

03-5001 - 03-5004
WAGENER
150 mm

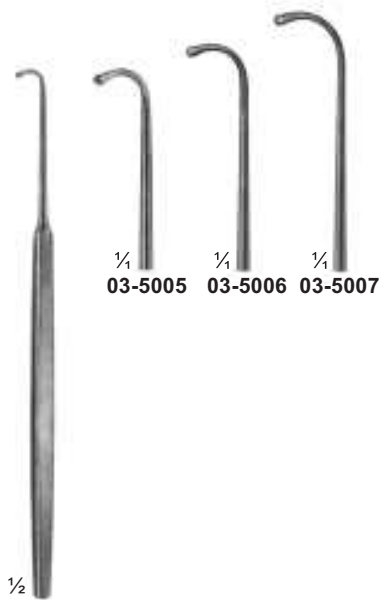

03-5005 - 03-5007
GRAEFE
140 mm



03-5008
BROM
Vein hook
170 mm



03-5009
CRILE
200 mm



03-5010 - 03-5011
CUSHING
190 mm

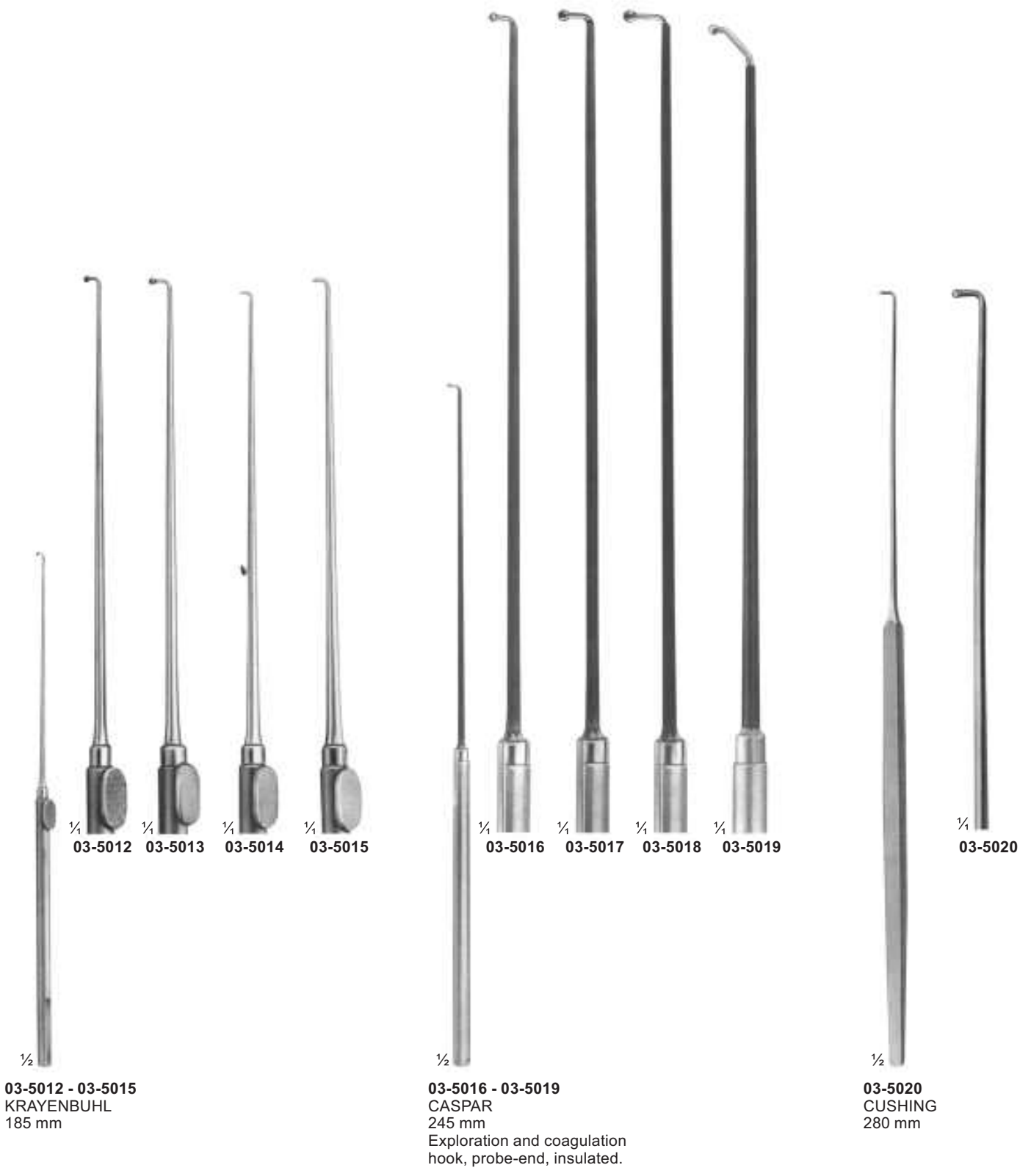

03-5012 - 03-5015
KRAYENBUHL
185 mm

03-5016 - 03-5019
CASPAR
245 mm
Exploration and coagulation
hook, probe-end, insulated.

03-5020
CUSHING
280 mm

Fine Wound Retractors (Dura- and Skin Retractors)

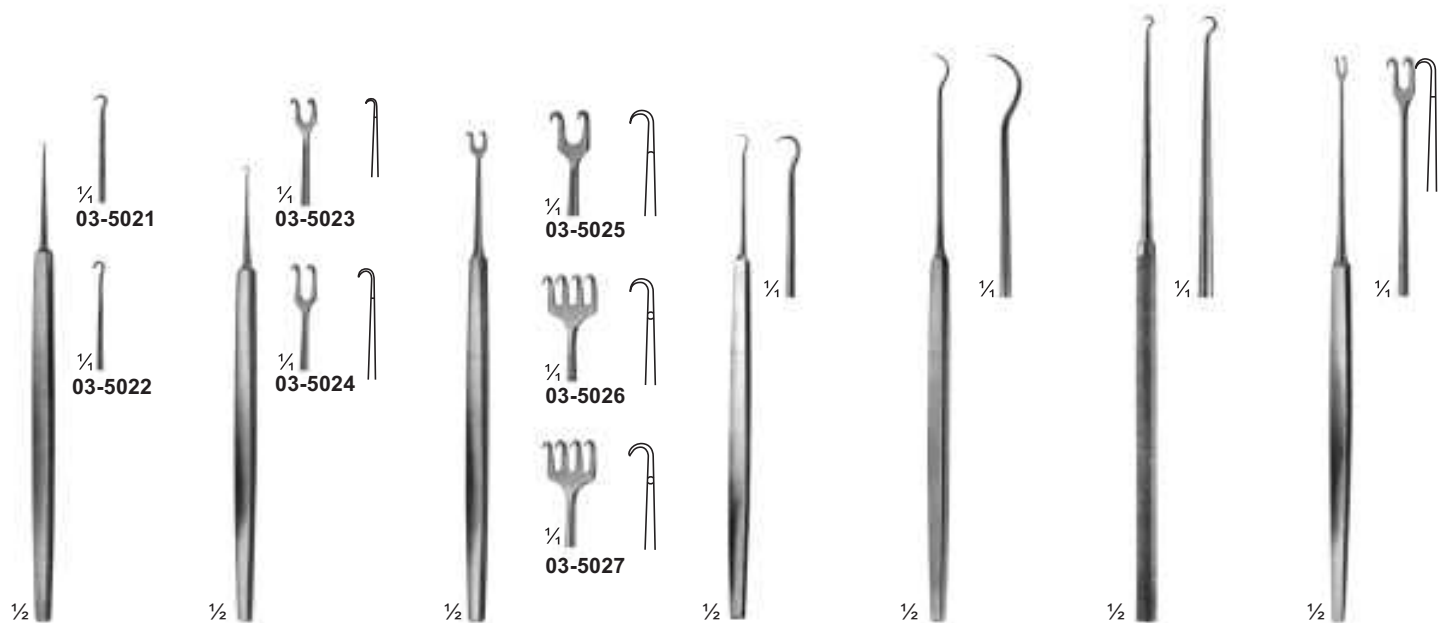

03-5021 - 03-5022
03-5021 Sharp
03-5022 Blunt
 GRAEFE
 125 mm

03-5023 - 03-5024
03-5023 125 mm
03-5024 130 mm
 Sharp
 GUTHRIE

03-5025 - 03-5027
03-5025 130 mm
03-5026 135 mm
 Sharp
03-5027 135 mm
 Blunt
 ROLLET

03-5028
 FRAZIER
 Dura Retractor
 130 mm

03-5029
 TOENNIS
 Dura Retractor
 150 mm

03-5030
 KILNER
 160 mm

03-5031
 FREER
 150 mm

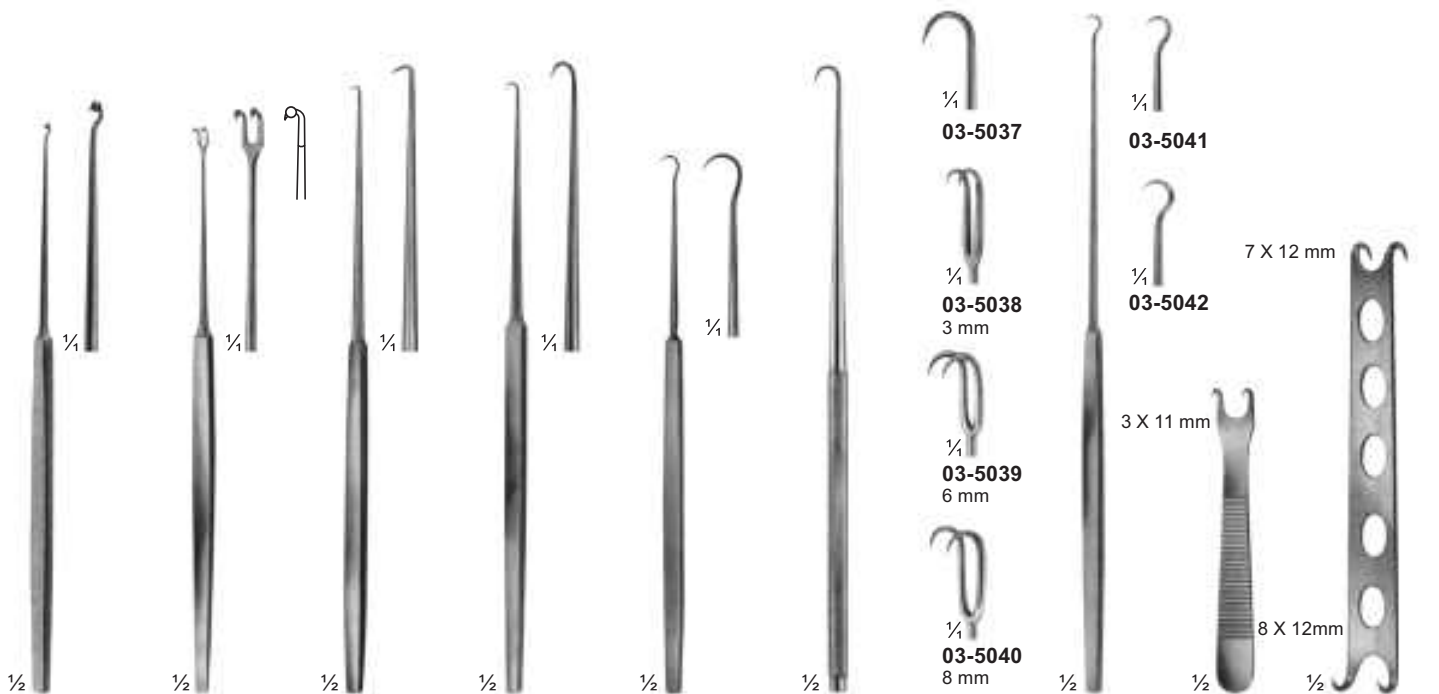

03-5032
 MULLER
 150 mm

03-5033
 MULLER
 150 mm

03-5034
 COTTLE
 160 mm

03-5035
 COTTLE
 160 mm

03-5036
 JAEGER
 135 mm

03-5037 - 03-5040
 JOSEPH
 165 mm

03-5041 - 5042
 GILLIES
 180 mm

03-5043
 KILNER
 Sharp
 80 mm

03-5044
 CONVERSE
 Blunt
 120 mm

Wound - Trachea Retractors



03-5045
BERGMANN
140 mm

03-5046
BOSE
165 mm

03-5047
BOSE
165 mm

03-5048 - 03-5050
180 mm

03-5048
Sharp

03-5049
Blunt

03-5050
Blunt

03-5051 - 03-5053
Flexible shaft, sharp
155 mm

03-5054 - 03-5056
Flexible shaft, blunt
155 mm

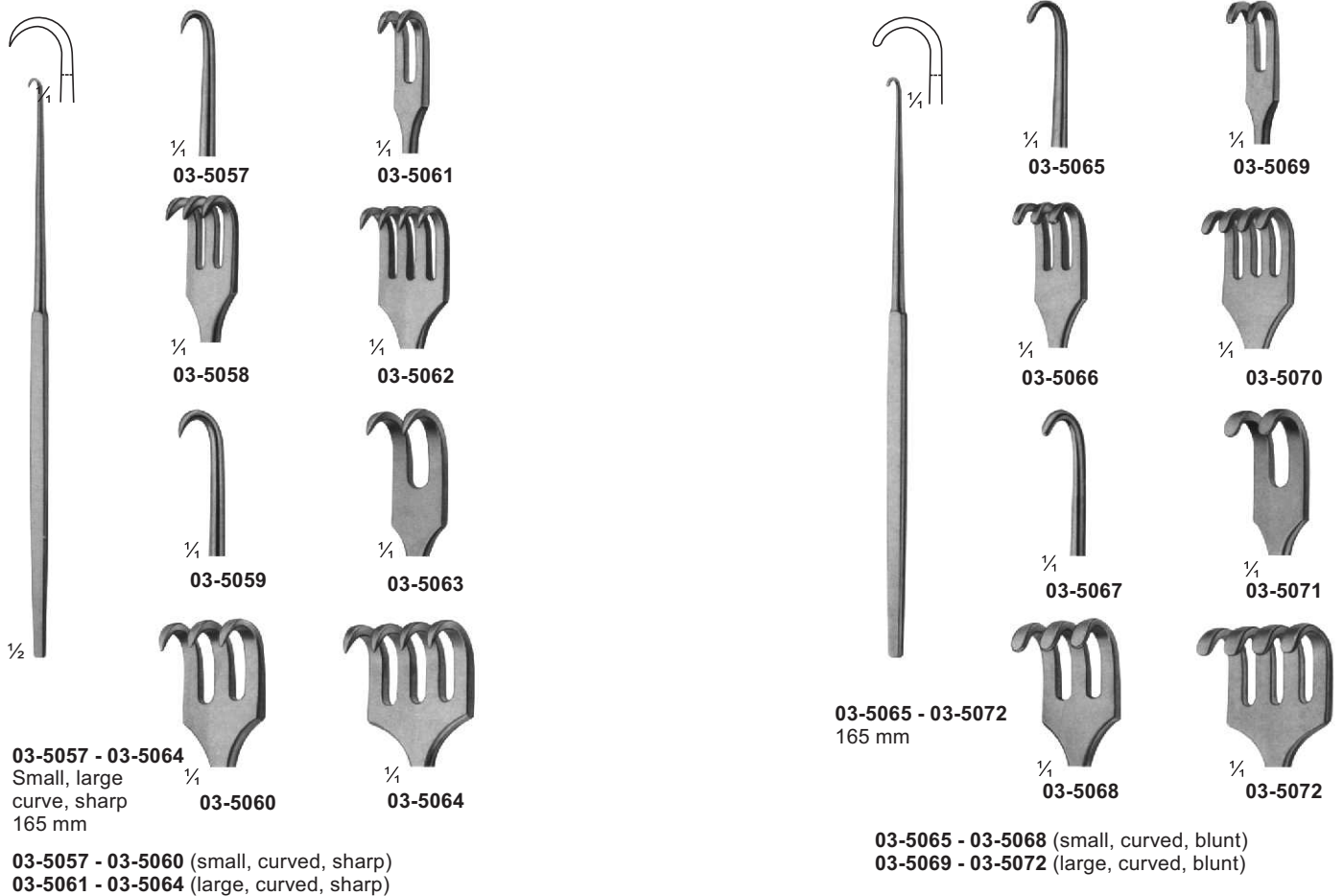

03-5057 - 03-5064
Small, large
curve, sharp
165 mm

03-5060

03-5064

03-5057 - 03-5060 (small, curved, sharp)
03-5061 - 03-5064 (large, curved, sharp)

03-5065 - 03-5072
165 mm

03-5068

03-5072

03-5065 - 03-5068 (small, curved, blunt)
03-5069 - 03-5072 (large, curved, blunt)

Retractors With Treangle Handle

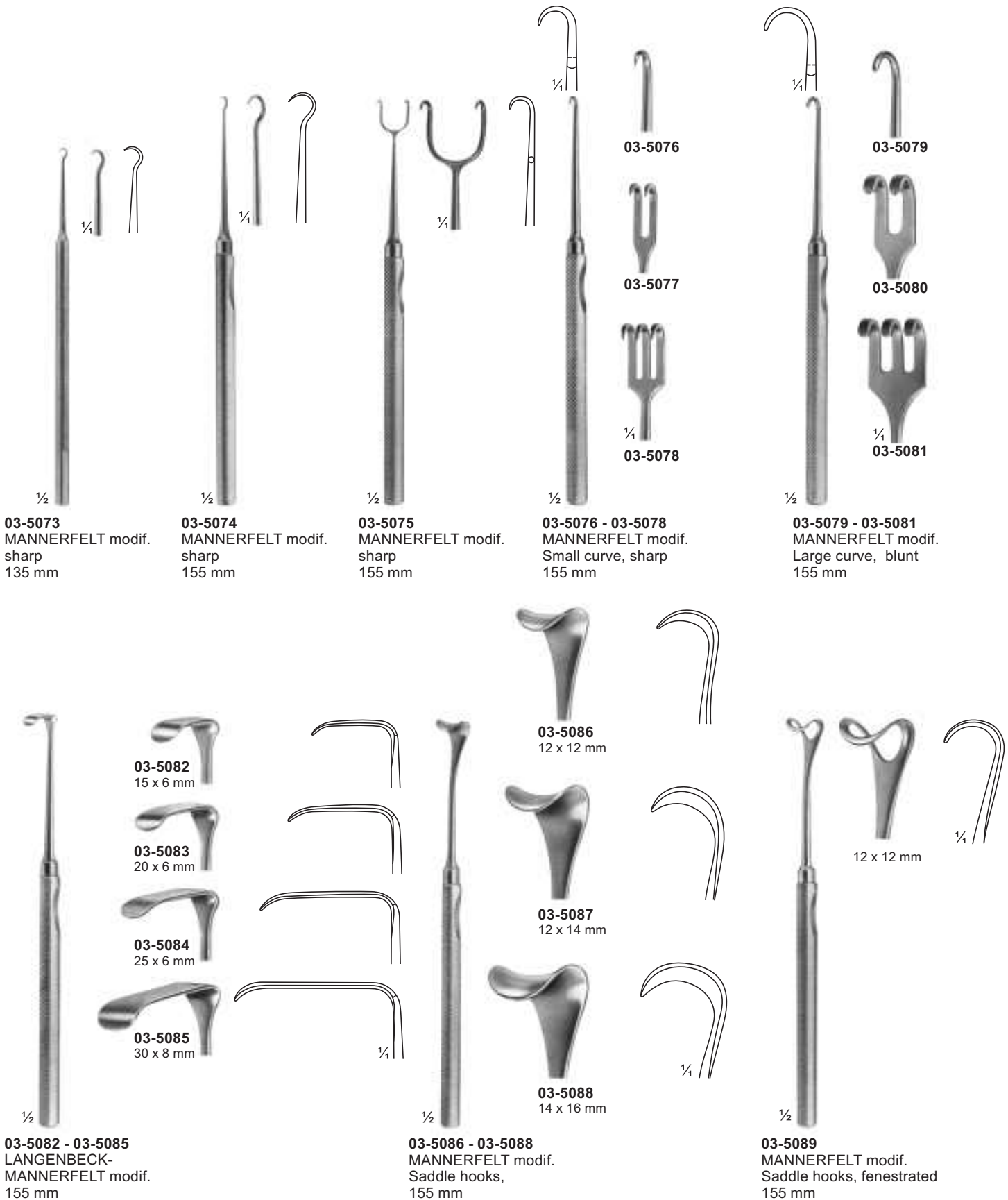

03-5073
MANNERFELT modif.
sharp
135 mm

03-5074
MANNERFELT modif.
sharp
155 mm

03-5075
MANNERFELT modif.
sharp
155 mm

03-5076 - 03-5078
MANNERFELT modif.
Small curve, sharp
155 mm

03-5079 - 03-5081
MANNERFELT modif.
Large curve, blunt
155 mm

03-5082
15 x 6 mm

03-5083
20 x 6 mm

03-5084
25 x 6 mm

03-5085
30 x 8 mm

03-5086
12 x 12 mm

03-5087
12 x 14 mm

03-5088
14 x 16 mm

12 x 12 mm

03-5082 - 03-5085
LANGENBECK-
MANNERFELT modif.
155 mm

03-5086 - 03-5088
MANNERFELT modif.
Saddle hooks,
155 mm

03-5089
MANNERFELT modif.
Saddle hooks, fenestrated
155 mm

Retractors



03-5090
FOMON
145 mm



03-5091 - 03-5092
160 mm



03-5093 - 03-5094
LANGENBECK-GREEN
160 mm

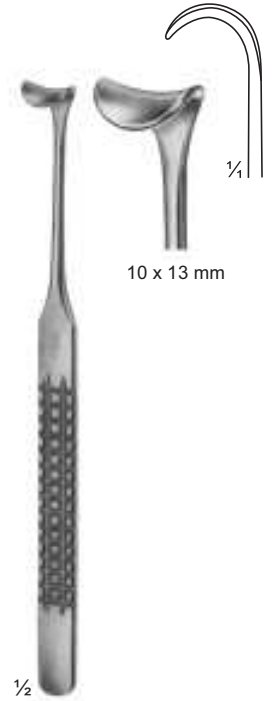

03-5095
160 mm



03-5096 - 03-5101
MEYERDING
Fig. A - Fig. F
180 mm



A
03-5096
18 x 7 mm

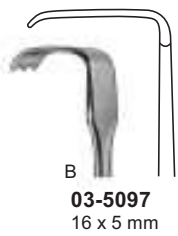

B
03-5097
16 x 5 mm

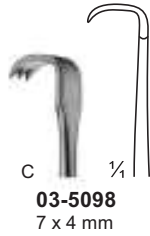

C
03-5098
7 x 4 mm

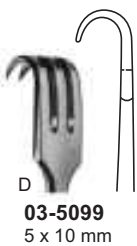

D
03-5099
5 x 10 mm

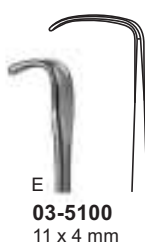

E
03-5100
11 x 4 mm

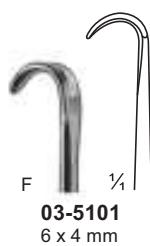

F
03-5101
6 x 4 mm

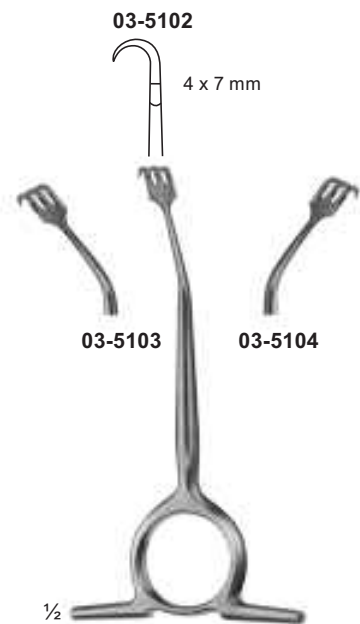

03-5102
4 x 7 mm

03-5103

03-5104

03-5102 - 03-5104
WILLIGER
120 mm

Retractors



03-5105
EMMET
Fistula hook
220 mm



03-5106
SIMON
Fistula hook
220 mm



03-5107
SIMON
Fistula hook
220 mm



03-5108
LANGE
Fistula hook
230 mm

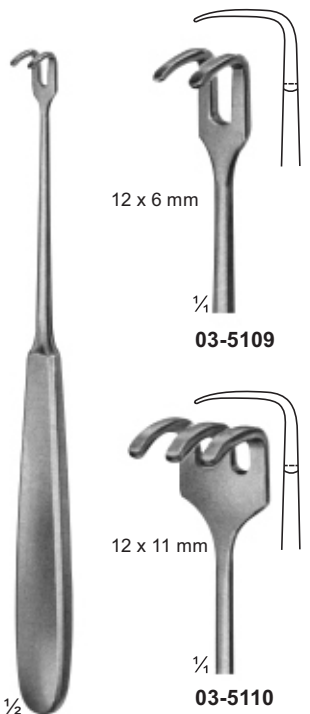

03-5109 - 03-5110
Tendon hooks
175 mm

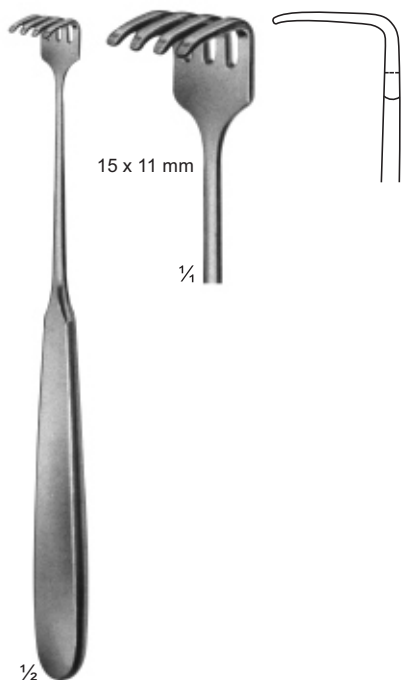

03-5111
KLAPP
Tendon hooks
175 mm

Wound and Vein Retractors

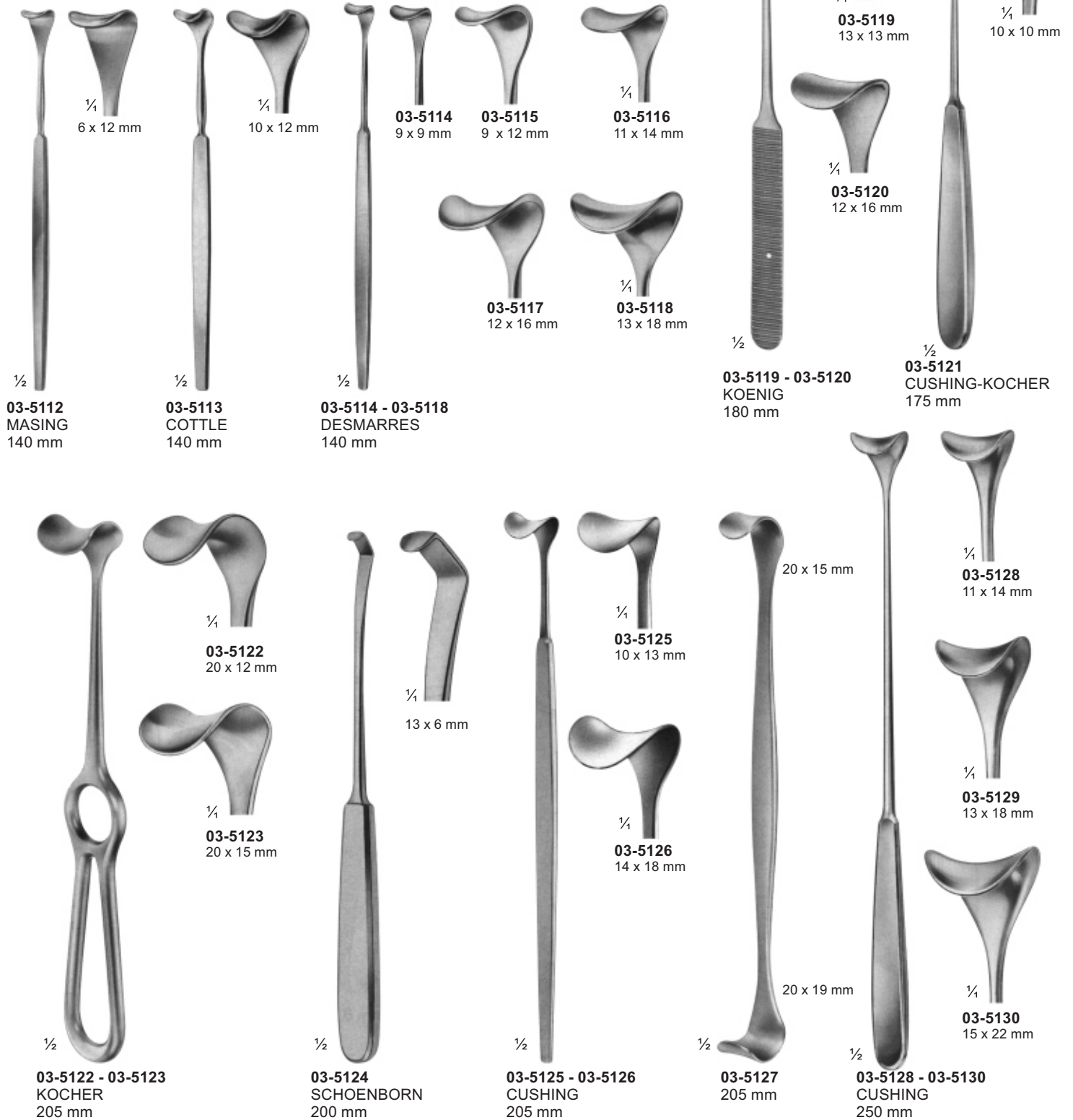

Retractors

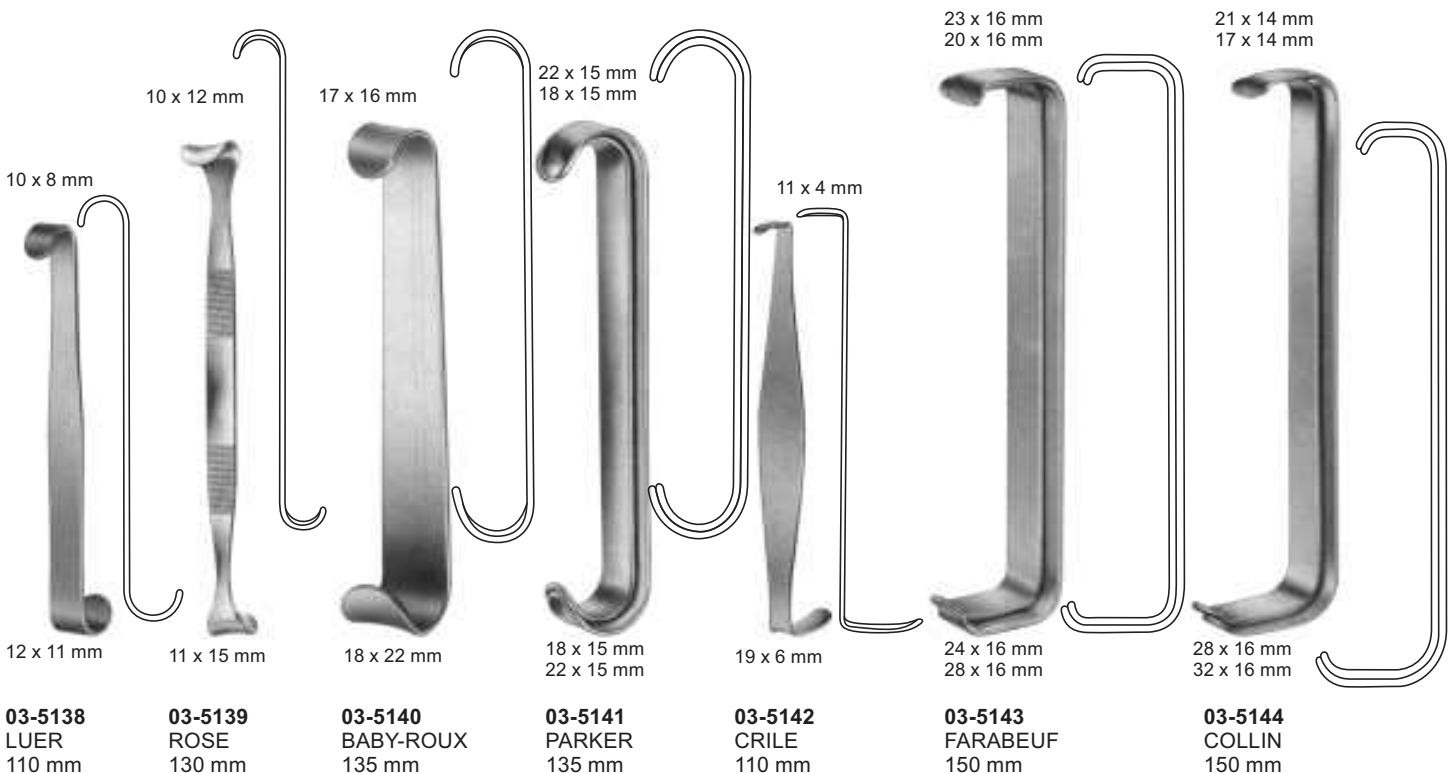
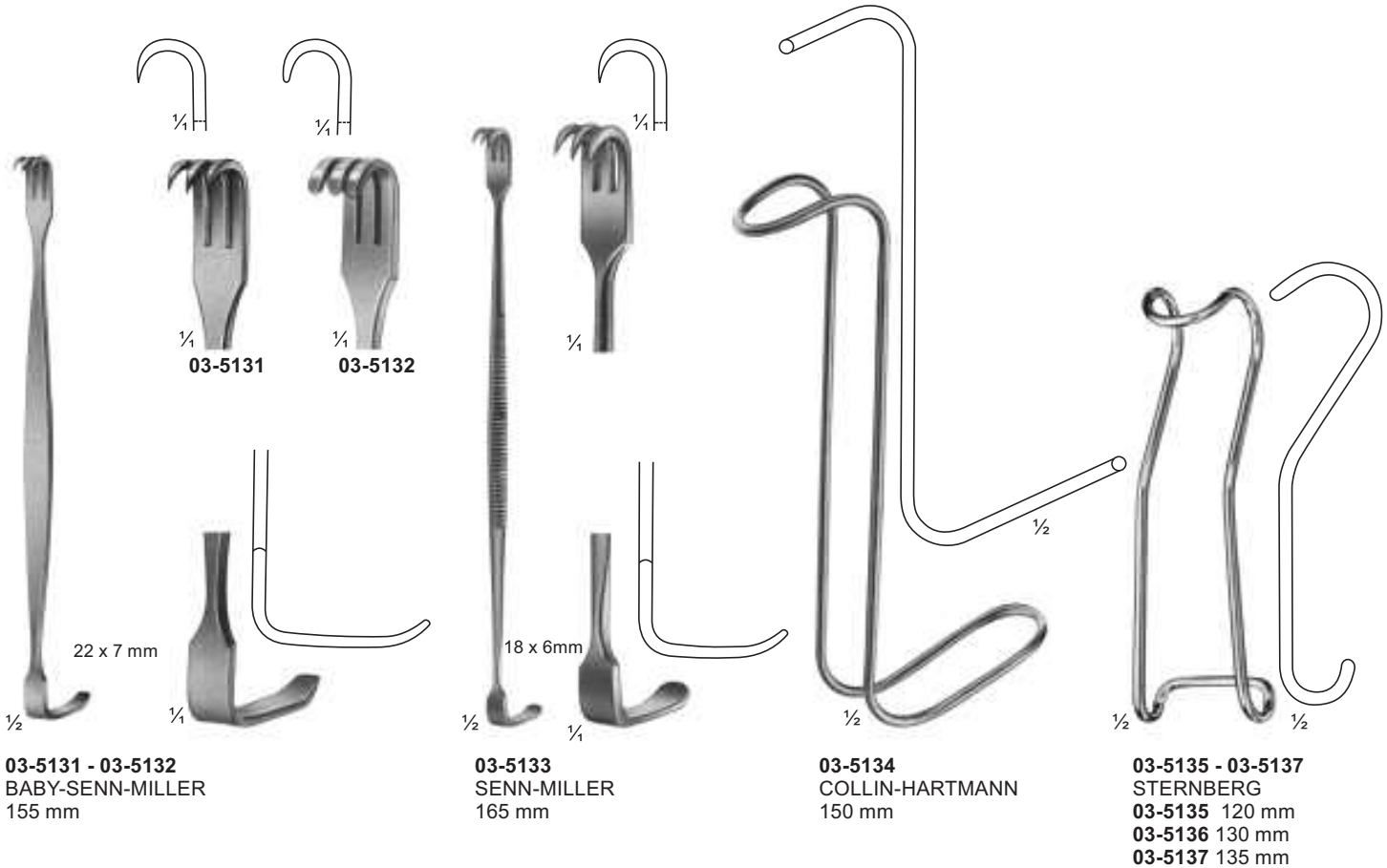

Retractors

 <p>03-5145 ROUX Set 165 mm</p>	<p>19 x 22 mm</p>  <p>03-5146 23 x 30 mm</p>	<p>25 x 26 mm</p>  <p>03-5147 28 x 38 mm</p>	<p>28 x 29 mm</p>  <p>03-5148 33 x 45 mm</p>	 <p>03-5149 ROUX</p>	<p>20 x 22 mm</p>  <p>03-5150 25 x 29 mm 150mm</p>	<p>25 x 26 mm</p>  <p>03-5151 30 x 38 mm 160mm</p>
 <p>03-5152 CZERNY 175 mm</p>	<p>36 mm</p>  <p>38 x 42 mm</p>	<p>47 x 13 mm 41 x 13 mm</p>  <p>03-5153 MATHIEU 200 mm</p>		<p>26 x 15 mm 22 x 15 mm</p>  <p>03-5154 US-ARMY 220 mm</p>		

Bone Retractors and Retractors



03-5155
KOCHER
Sharp
205 mm



03-5156
KOCHER
Sharp
220 mm



03-5157
VOLKMANN
Sharp
220 mm



03-5158
VOLKMANN
Blunt
220 mm



03-5159
VOLKMANN
Sharp
220 mm



03-5160 - 03-5167
VOLKMANN
225 mm

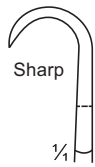

03-5160
9 x 8 mm



03-5161
9 x 13 mm



03-5162
9 x 19 mm



03-5163
9 x 29 mm

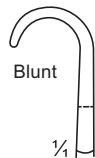

03-5164
8,5 x 8 mm



03-5165
8,5 x 13 mm



03-5166
8,5 x 19 mm



03-5167
8,5 x 29 mm

Retractors

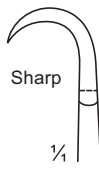

03-5168
9 x 8 mm



03-5169
9 x 13 mm



03-5170
9 x 19 mm



03-5171
9 x 29 mm



03-5172
9 x 40 mm

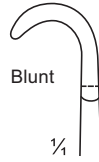

03-5173
8 x 8 mm



03-5174
8 x 13 mm



03-5175
8 x 19 mm



03-5176
8 x 29 mm



03-5177
8 x 40 mm



03-5178
8,5 x 8 mm



03-5179
8,5 x 13 mm



03-5180
8,5 x 19 mm



03-5181
8,5 x 29 mm

03-5168 - 03-5181
VOLKMANN
220 mm

1/2

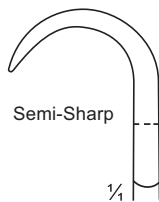

03-5182
16 x 9 mm



03-5183
16 x 14 mm



03-5184
16 x 20 mm



03-5185
16 x 30 mm

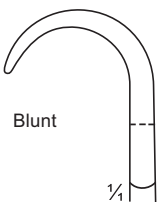

03-5186
15,5 x 9 mm



03-5187
15,5 x 14 mm



03-5188
15,5 x 20 mm



03-5189
15,5 x 30 mm

03-5182 - 03-5189
KOCHER
220 mm

1/2

Retractors, Deep form



03-5190 - 03-5191
KOERTE
 Handle vertical
 to the blade.
 240 mm



03-5190
 8 Prongs, blunt



03-5191
 8 Prongs, sharp



03-5192 - 03-5195
ISRAEL
 255 mm

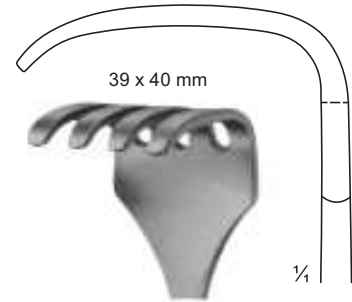

03-5192
 4 Prongs, blunt

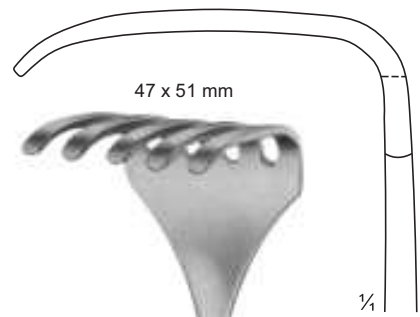

03-5193
 5 Prongs, blunt

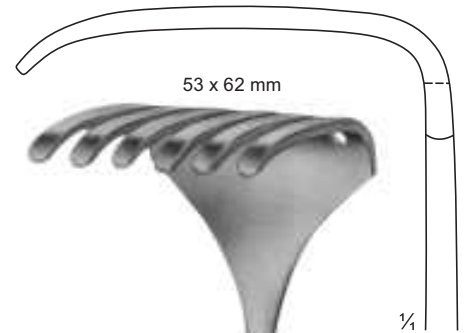

03-5194
 6 Prongs, blunt

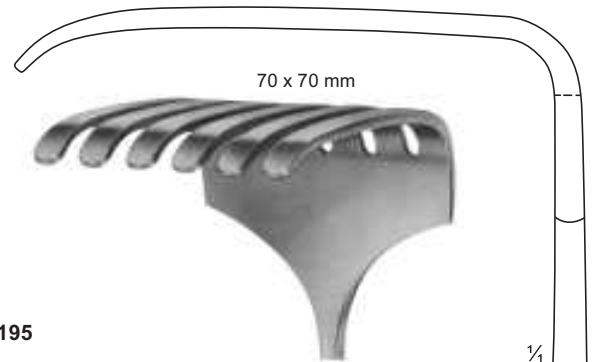

03-5195
 6 Prongs, blunt

Retractors



03-5196 - 03-5201
LANGENBECK
210 mm

- 03-5196** 28 x 10 mm
- 03-5197** 28 x 14 mm
- 03-5198** 33 x 14 mm
- 03-5199** 28 x 16 mm
- 03-5200** 40 x 10 mm
- 03-5201** 40 x 13 mm



03-5202 - 03-5210
KOCHER-LANGENBECK
215 mm

- 03-5202** 25 x 6 mm
- 03-5203** 35 x 8 mm
- 03-5204** 35 x 11 mm
- 03-5205** 35 x 15 mm
- 03-5206** 41 x 11 mm
- 03-5207** 55 x 11 mm
- 03-5208** 70 x 14 mm
- 03-5209** 80 x 12mm
- 03-5210** 80 x 16mm



03-5211
LANGENBECK
215 mm

Retractors



03-5212 - 03-5216
KOCHER
230 mm

1/2



03-5217 - 03-5219
SAUERBRUCH
225 mm

1/2

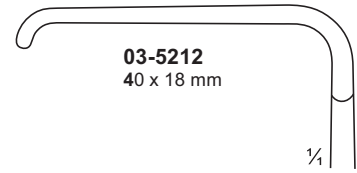

03-5212
40 x 18 mm

1/4

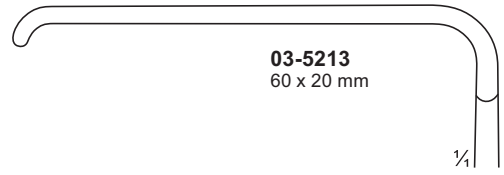

03-5213
60 x 20 mm

1/4

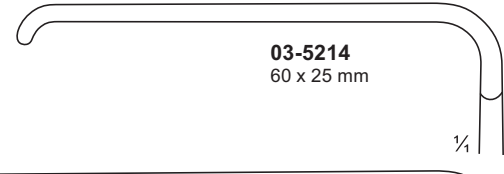

03-5214
60 x 25 mm

1/4



03-5215
75 x 30 mm

1/4

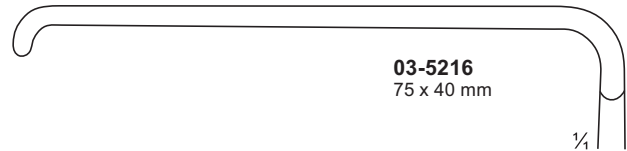

03-5216
75 x 40 mm

1/4

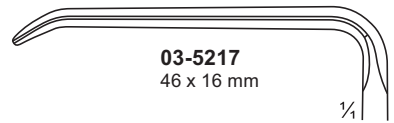

03-5217
46 x 16 mm

1/4

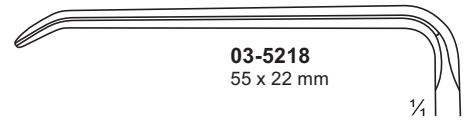

03-5218
55 x 22 mm

1/4



03-5219
72 x 19 mm

1/4

Retractors

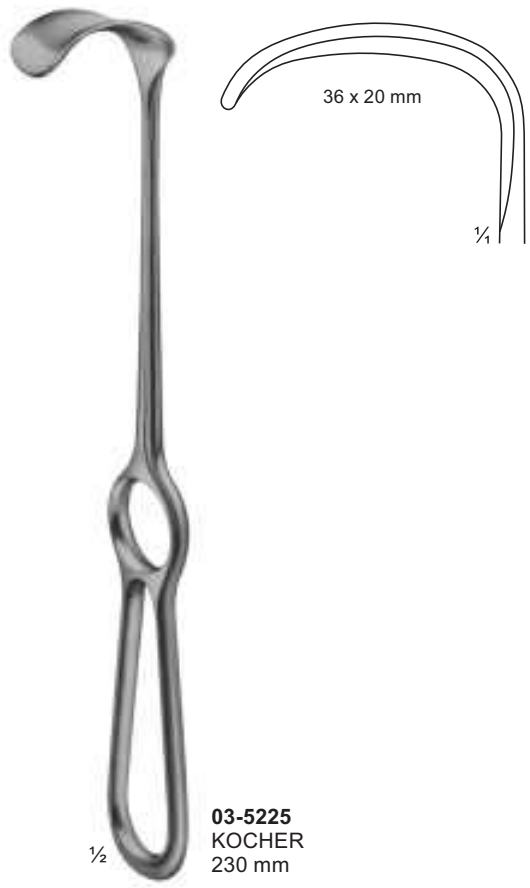
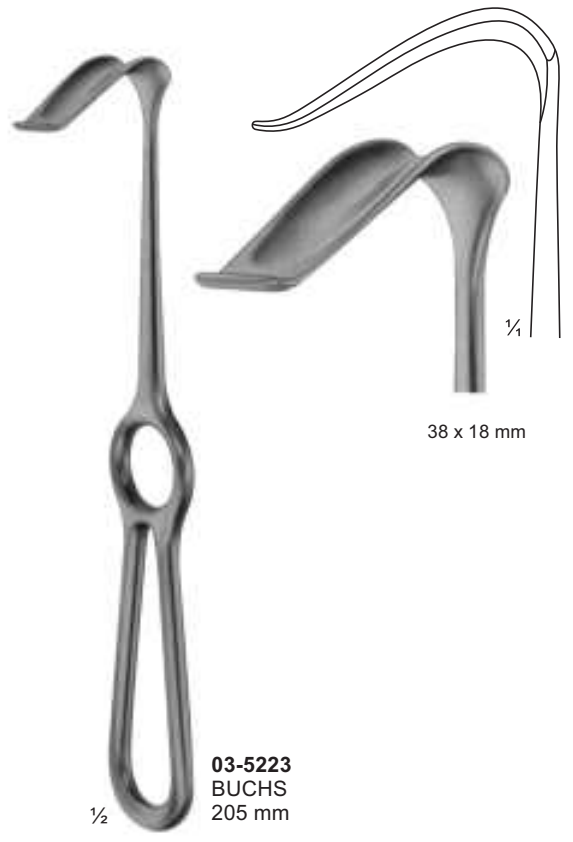
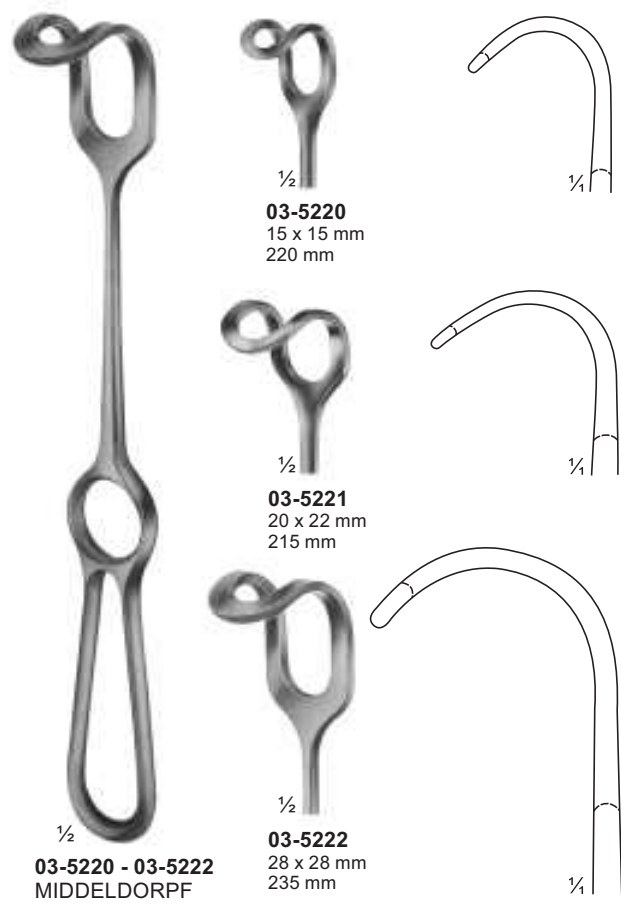

Retractors



1/2

03-5226 - 03-5231
HOSEL
250 mm

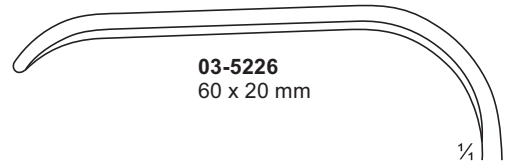

03-5226
60 x 20 mm

1/4

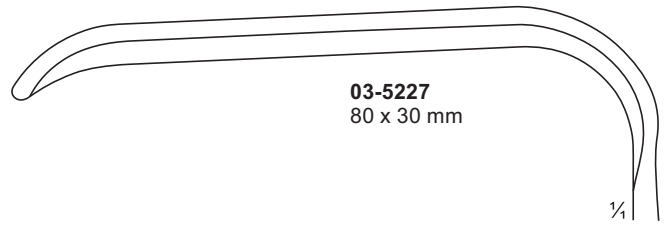

03-5227
80 x 30 mm

1/4

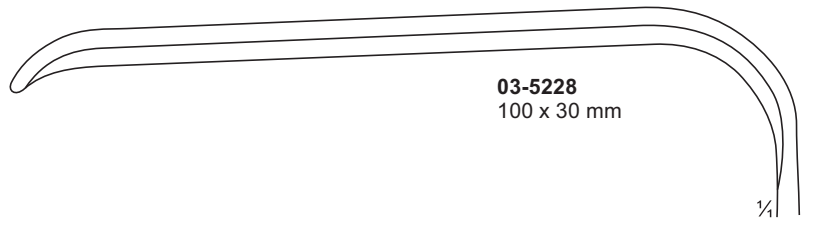

03-5228
100 x 30 mm

1/4

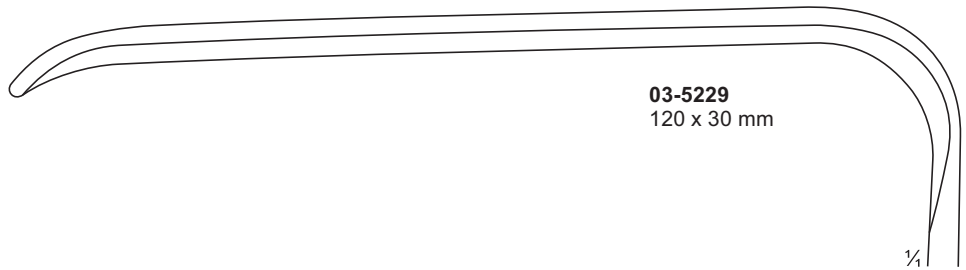

03-5229
120 x 30 mm

1/4

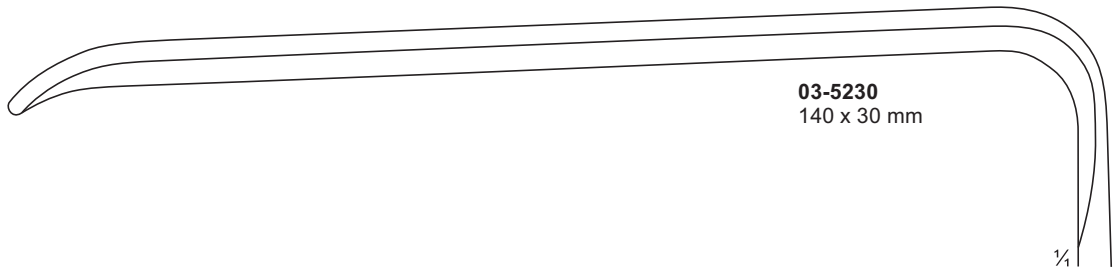

03-5230
140 x 30 mm

1/4

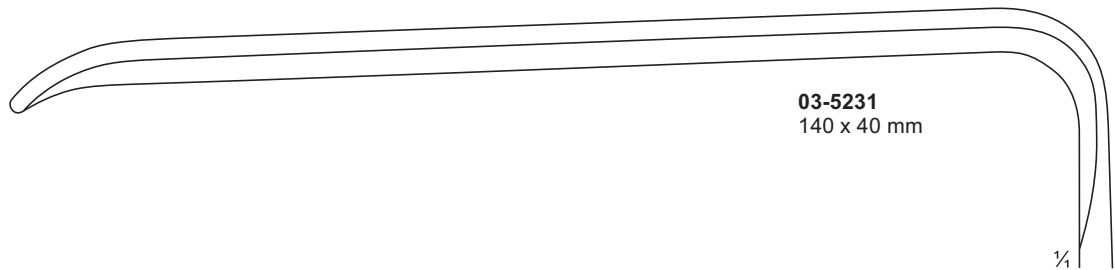

03-5231
140 x 40 mm

1/4

Retractors

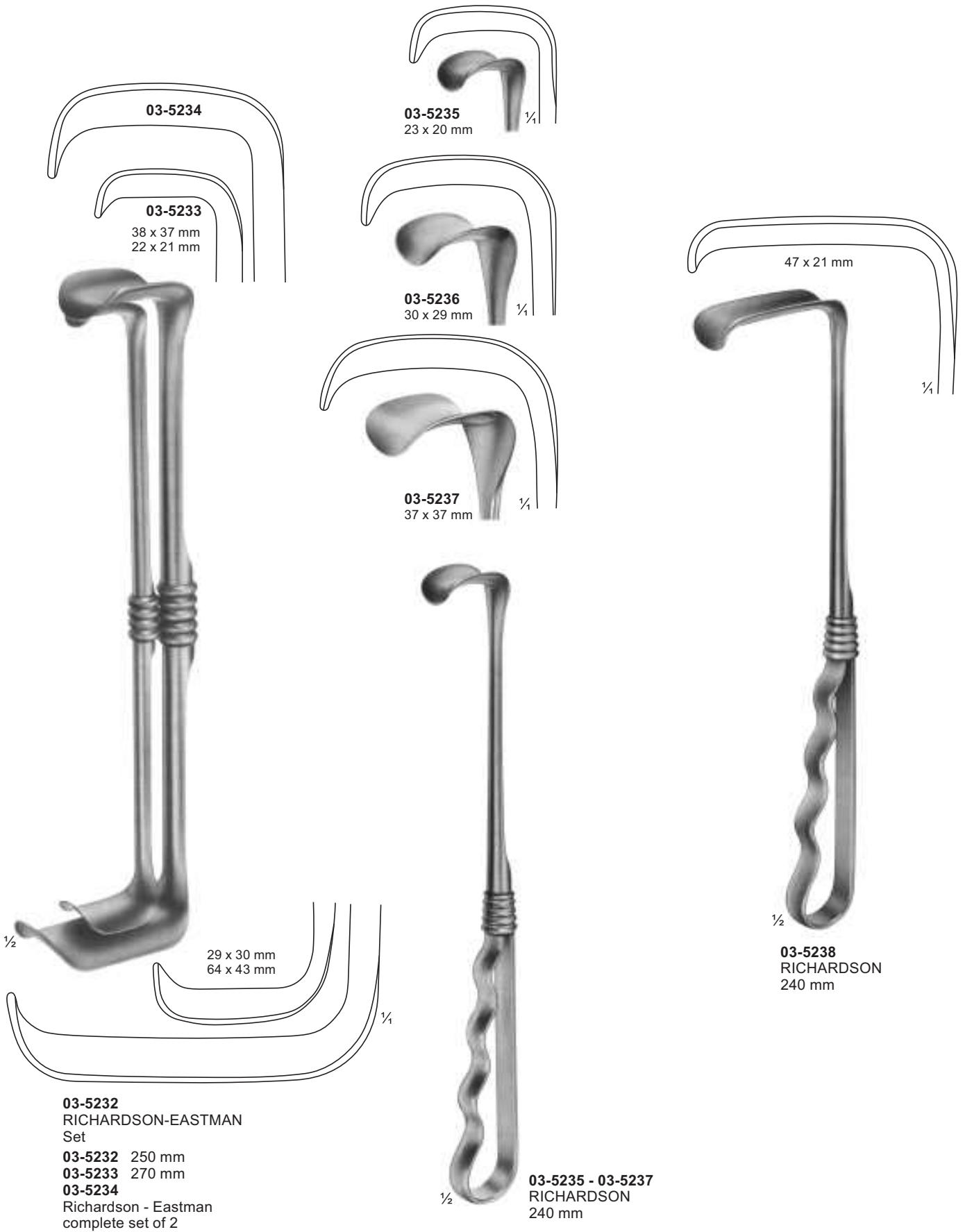

Retractors

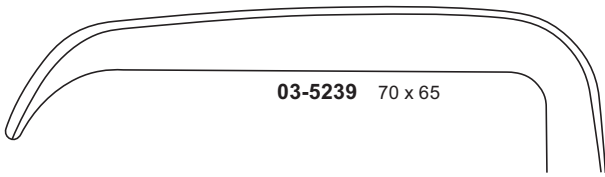

03-5239 70 x 65

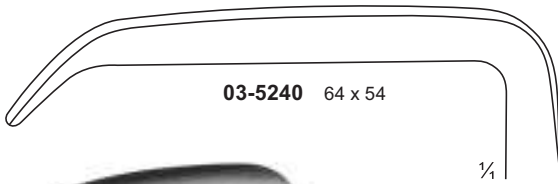

03-5240 64 x 54



1/2

03-5239 - 03-5240
KELLY
260 mm



03-5241 70 x 50
03-5242 70 x 65



1/2

03-5241 - 03-5242
MORRIS
245 mm

Retractors For Deep Surgery

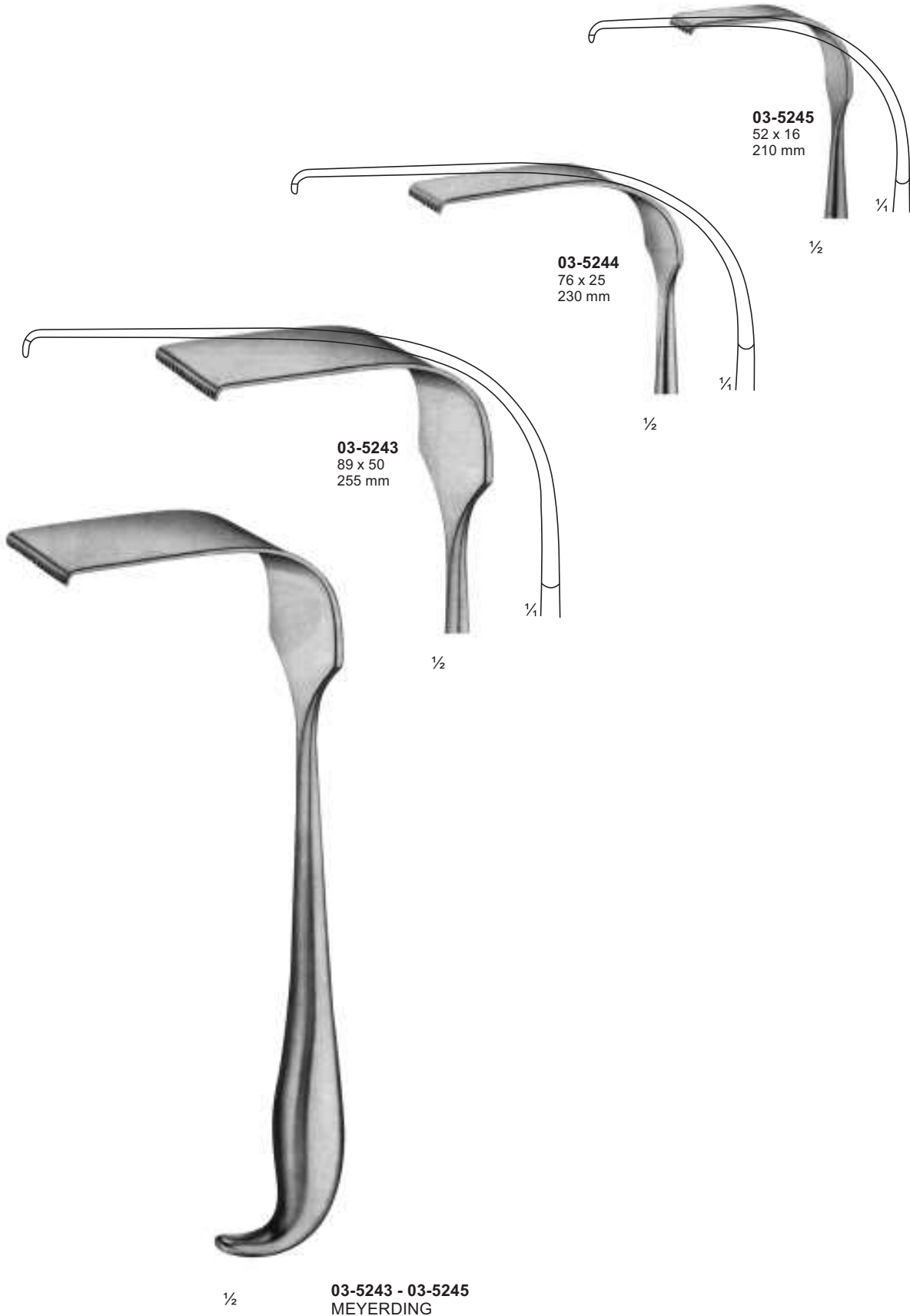

Retractors For Deep Surgery

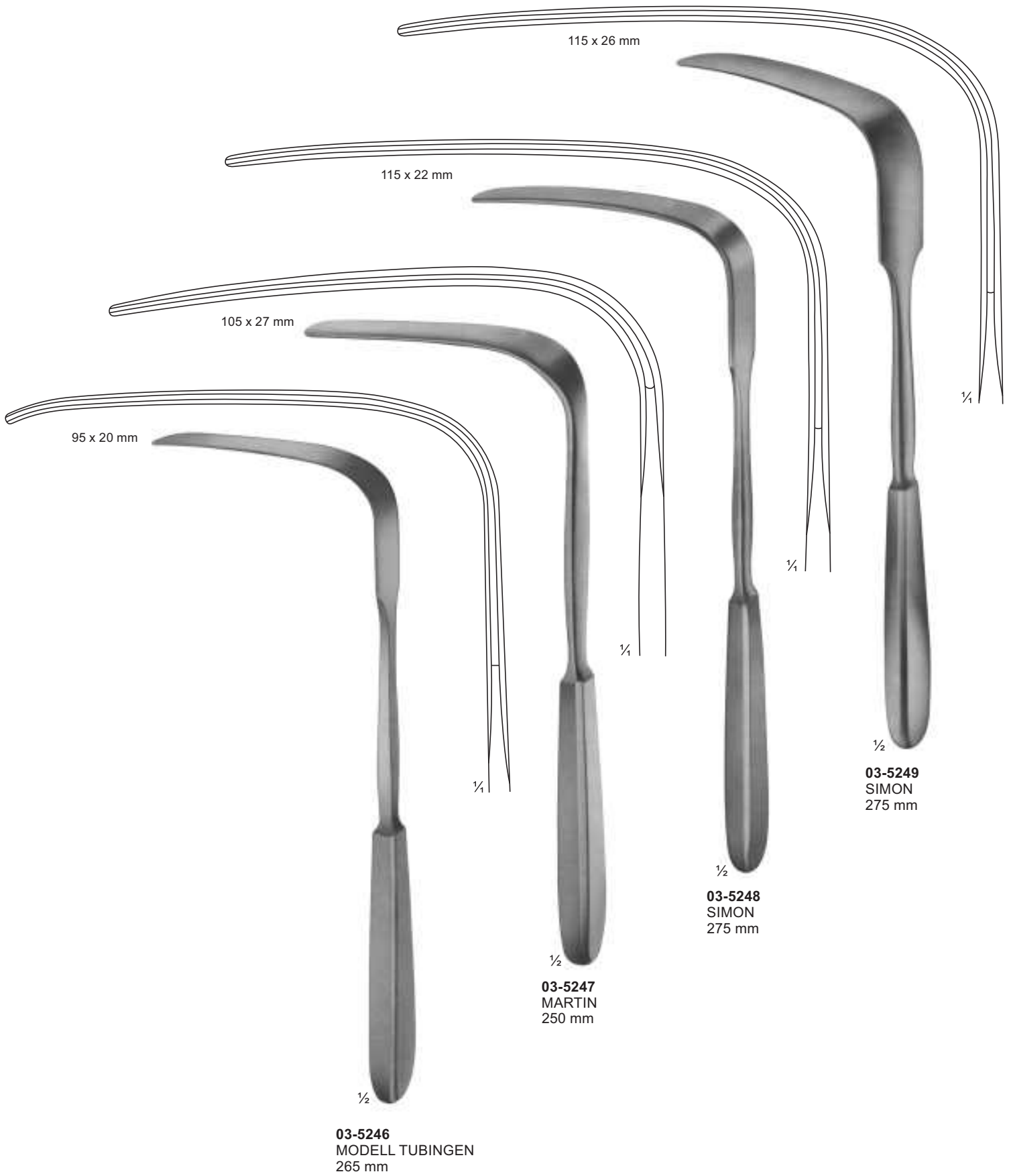

Retractors, Vario Retractor System, Germ. F
 Patent, Germ. Fed. Regd.Des, US-Patent.

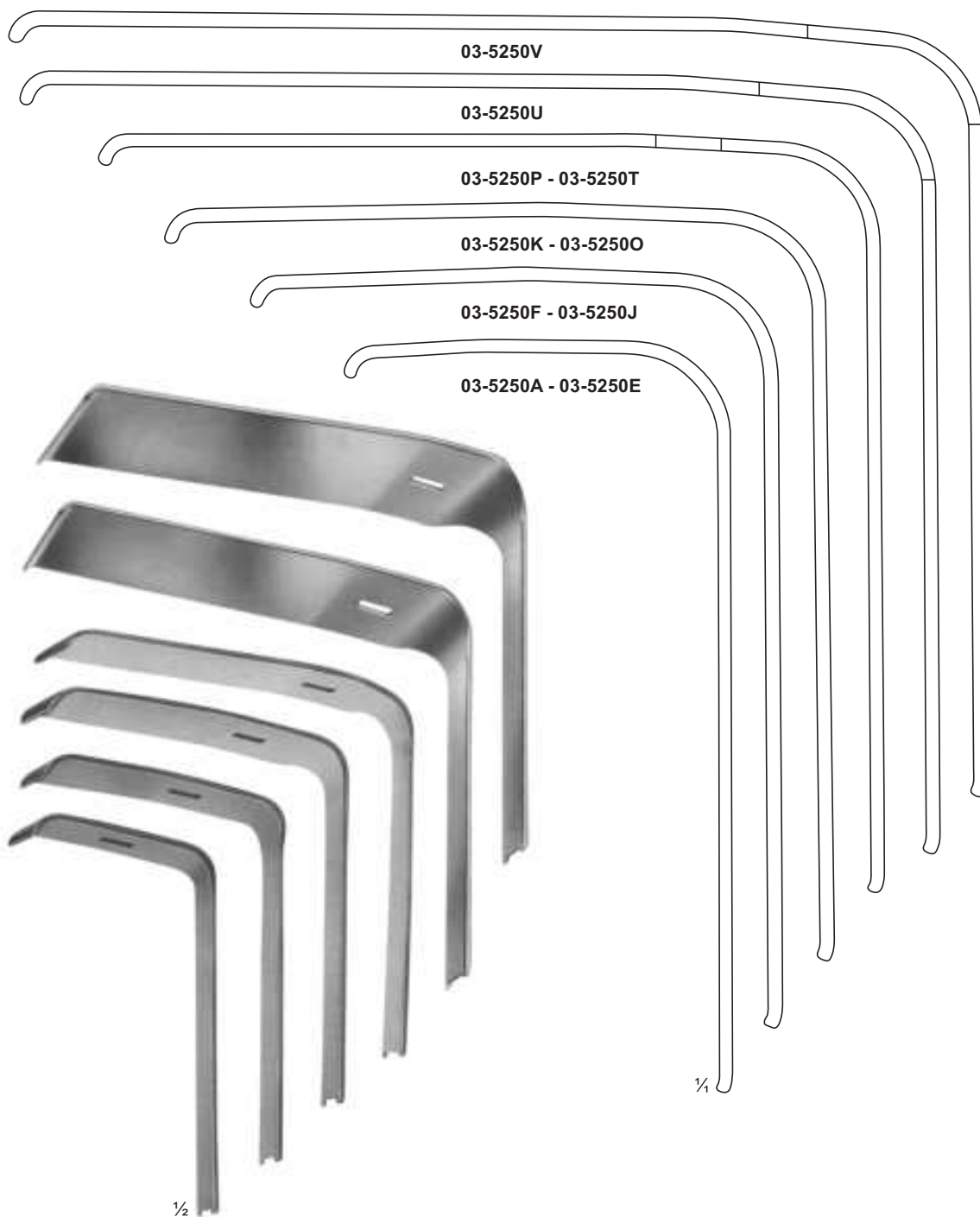

Retractor blades for handles 03-5250

Depth	Width	14mm	18mm	22mm	26mm	30mm	40mm	50mm
55mm	03-5250A	03-5250B	03-5250C	03-5250D	03-5250E	-	-	-
75mm	03-5250F	03-5250G	03-5250H	03-5250I	03-5250J	-	-	-
95mm	03-5250K	03-5250L	03-5250M	03-5250N	03-5250O	-	-	-
115mm	03-5250P	03-5250Q	03-5250R	03-5250S	03-5250T	-	-	-
135mm	-	-	-	-	-	03-5250U	-	-
145mm	-	-	-	-	-	-	03-5250V	-

Retractors, Vario Retractor System, Germ. F
 Patent, Germ. Fed. Regd.Des, US-Patent.



03-5251 - 03-5257
 BRUNNER
 275 mm

03-5251	80 x 20
03-5252	100 x 25
03-5253	120 x 25
03-5254	130 x 30
03-5255	140 x 30
03-5256	160 x 30
03-5257	180 x 30

1/2



03-5258
 Handle with cold
 light carrier for
 retractor blades.
 280 mm

1/2



Handle arrange-
 ment variable

Retractors, Lung Spatulas

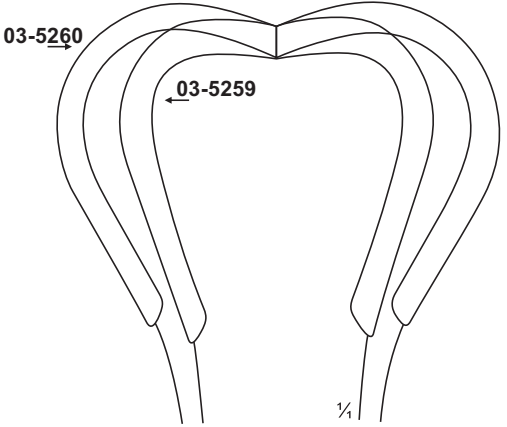

03-5259 - 03-5260
HARRINGTON
03-5259 123 x 45 mm
03-5260 123 x 64 mm
 Flexible
 295 mm



03-5261
ALLISON
 255 mm



03-5262
ALLISON
 320 mm

Retractors, Lung Spatulas



Retractors, Lung Spatulas

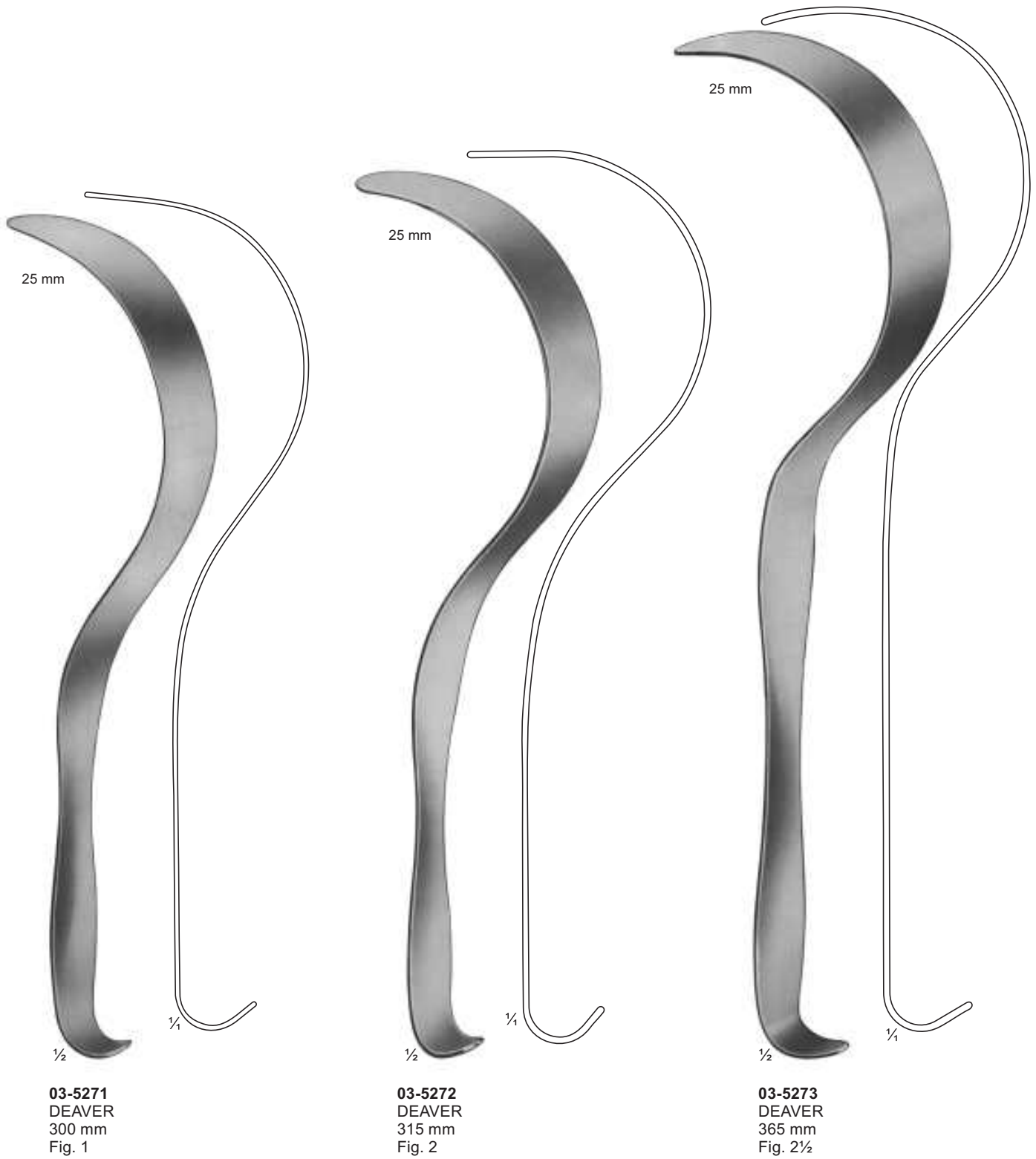

Retractors, Lung Spatulas



03-5274
DEAVER
300 mm
Fig. 3

03-5275
DEAVER
310 mm
Fig. 4

03-5276
DEAVER
320 mm
Fig. 5



03-5277
DEAVER
310 mm
Fig. 1



03-5278
DEAVER
310 mm
Fig. 3



03-5279
DEAVER
305 mm
Fig. 4



03-5280
DEAVER
310 mm
Fig. 5

Retractors For Deep Surgery (Abdominal Retractors)



03-5281
MIKULICZ
255 mm

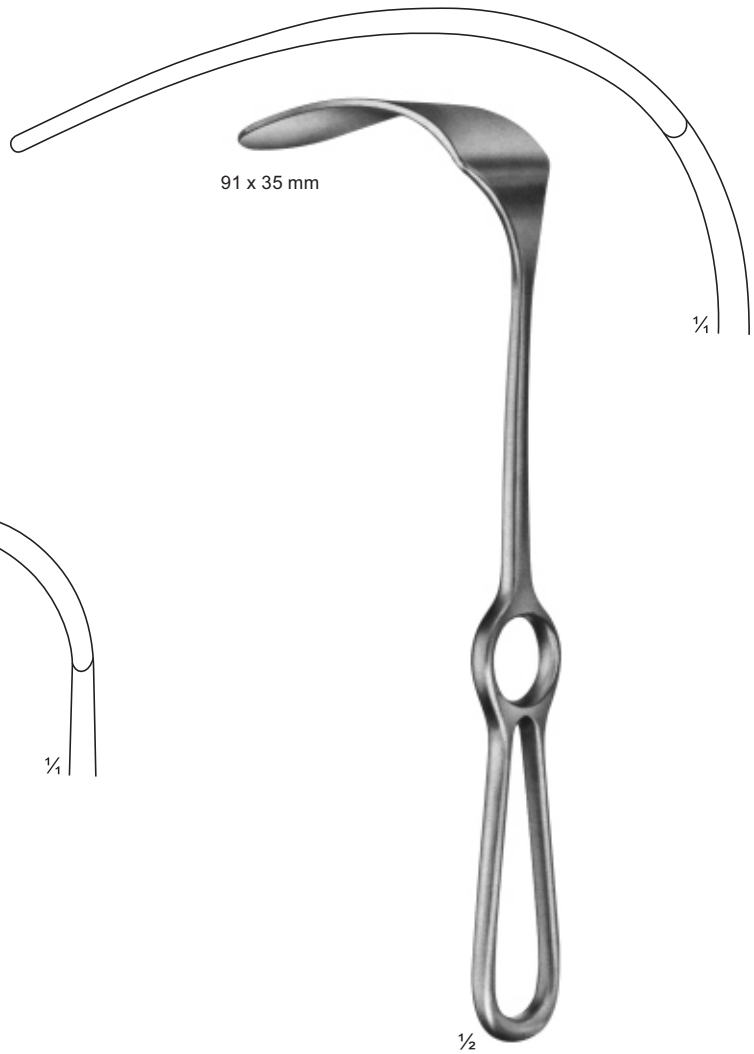

03-5282
MIKULICZ
250 mm

Retractors For Deep Surgery (Abdominal Retractors)

03-5285 150 x 39 mm
03-5286 150 x 57 mm

03-5283 121 x 50 mm
03-5284 147 x 50 mm

03-5285 - 03-5286
KELLY
03-5285 150 x 39 mm
03-5286 150 x 57 mm
260 mm

03-5283 - 03-5284
MIKULICZ
03-5283 121 x 50 mm
03-5284 147 x 50 mm
Liver Retractor
250 mm



Length of Blades	Width of Blades		
	35mm	45mm	60mm
62mm	03-5287	03-5290	03-5294
92mm	03-5288	03-5291	03-5295
122mm	03-5289	03-5292	03-5296
160mm		03-5293	03-5297

Abdominal Retractors



03-5304 - 03-5308
ROCHARD
 310 mm
03-5304 48 x 90 mm
03-5305 48 x 105 mm
03-5306 48 x 120 mm
03-5307 48 x 135 mm
03-5308 48 x 155 mm

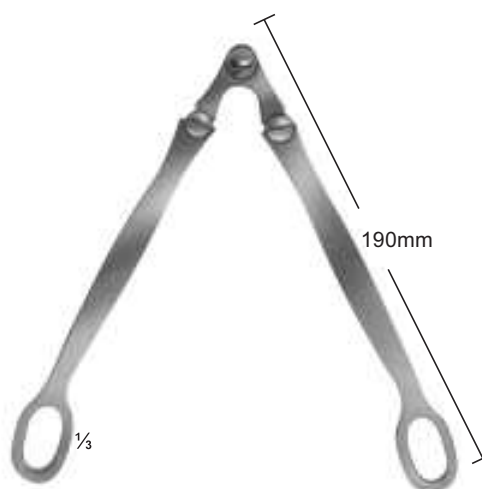

03-5309
ROCHARD
 Fixation device for



03-5310 - 03-5313
DOYEN
 280 mm
03-5310 48 x 90 mm
03-5311 48 x 105 mm
03-5312 48 x 120 mm
03-5313 48 x 135 mm



03-5314
DOYEN-CHILD
 Fixation device
 220 mm



03-5315
 Chain
 with weight
 645g
 790 mm

Pelvis Retractors

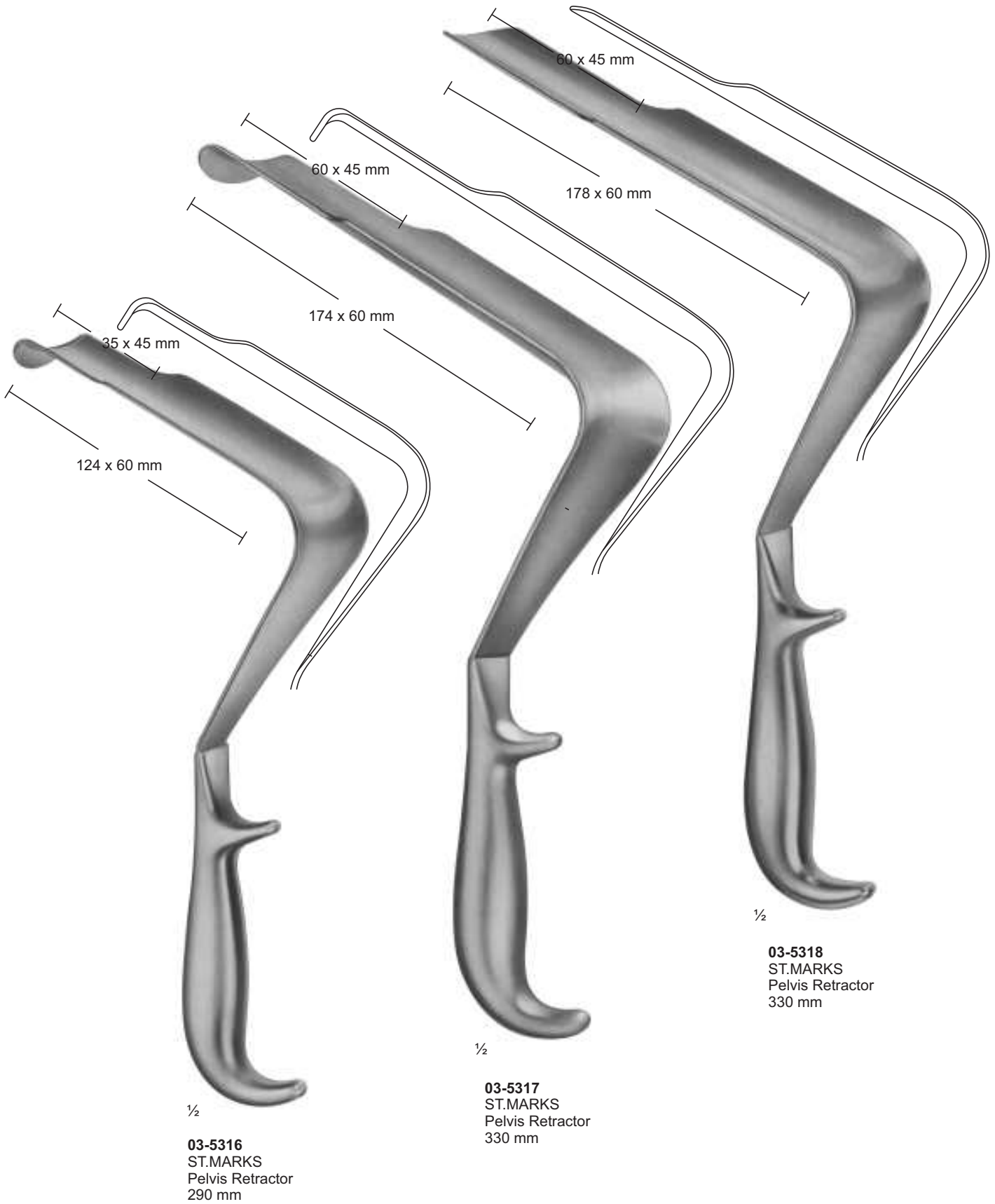

Abdominal- and Intestinal Spatulas

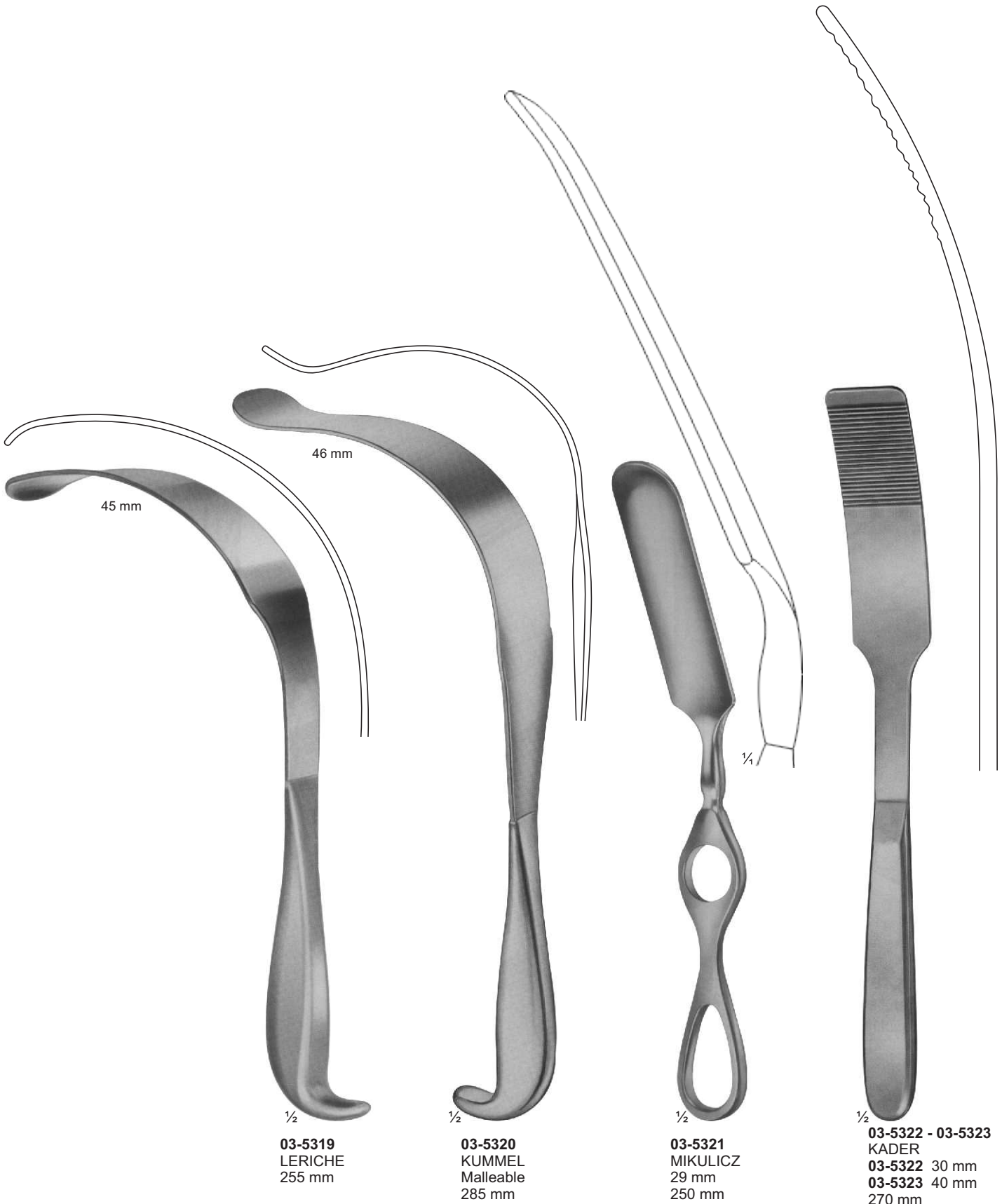

1/2
03-5319
 LERICHE
 255 mm

1/2
03-5320
 KUMMEL
 Malleable
 285 mm

1/2
03-5321
 MIKULICZ
 29 mm
 250 mm

1/2
03-5322 - 03-5323
 KADER
03-5322 30 mm
03-5323 40 mm
 270 mm

Abdominal- and Intestinal Spatulas



03-5324
REVERDIN
285 mm



03-5325
HABERER
Malleable
305 mm



03-5326 - 03-5328
03-5326 30 mm
03-5327 40 mm
03-5328 50 mm
Malleable
330 mm



03-5329
TUFFIER
Malleable
200 mm

Self-Retaining Retractors



03-5330
BOSE
60 mm



03-5331
FINSEN
50 mm



03-5332
FINSEN
70 mm



03-5333
FINSEN modif.
75 mm



03-5334
45 mm



03-5335
55 mm



03-5336
MUELLER
65 mm



03-5337
100 mm



03-5338



03-5339



03-5338 - 03-5339
03-5338 70 mm
03-5339 100 mm



03-5340
LOGAN
modif. REILL
50 mm



03-5341
JANSEN
100 mm



03-5342
JANSEN
100 mm

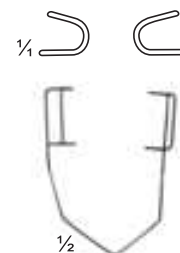

03-5343
BARRAQUER
45 mm

Self-Retaining Retractors



03-5344
WEITLANER
Sharp
110 mm



03-5345
WEITLANER
Semi-Sharp
110 mm



03-5346
WEITLANER
Blunt
110 mm



03-5347
WEITLANER
Sharp
130 mm



03-5348
WEITLANER
Semi-Sharp
130 mm



03-5349
WEITLANER
Blunt
130 mm

Self-Retaining Retractors

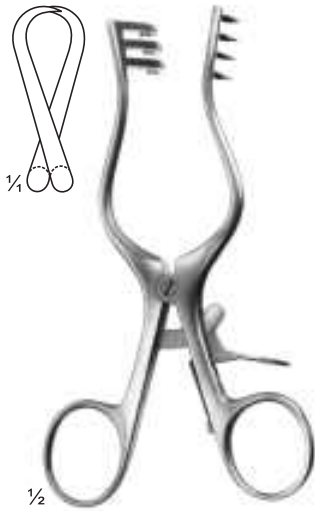

03-5350
WEITLANER
Sharp
130 mm

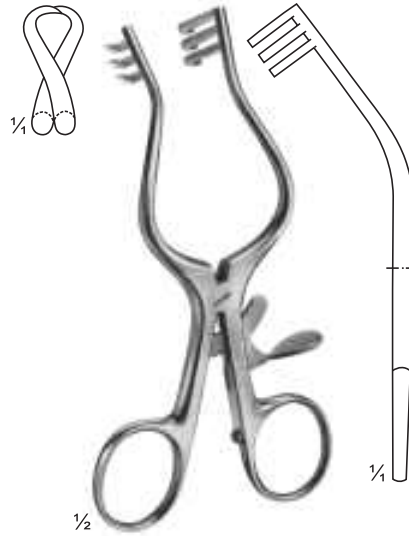

03-5351
WULLSTEIN
Sharp
130 mm

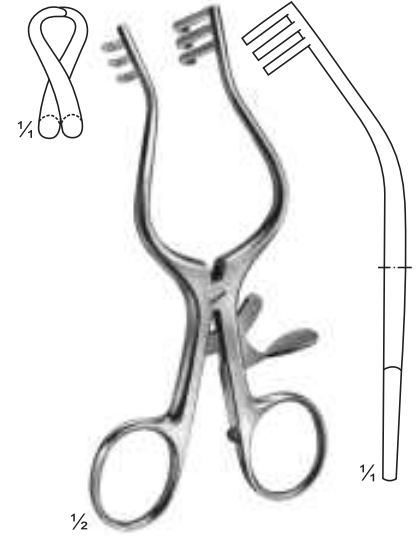

03-5352
WULLSTEIN
Blunt
130 mm



03-5353
WEITLANER
Sharp
165 mm

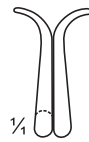

03-5354
PLESTER
Blunt
110 mm



03-5355
PERKINS
130 mm

Self-Retaining Retractors



03-5356
ADSON-BABY
Blunt
140 mm

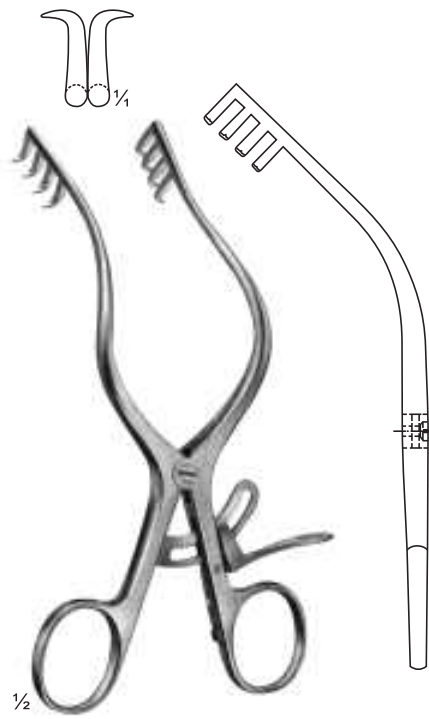

03-5357
MOLLISON
Sharp
155 mm



03-5358
MAYO-ADAMS
165 mm

Self-Retaining Laminectomy Retractors

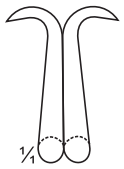

03-5359
ANDERSON-ADSON
Sharp
190 mm



03-5360
NORFOLK and
NORWICH
Blunt
220 mm



03-5361
ADSON
Sharp
265 mm

Self-Retaining Laminectomy Retractors

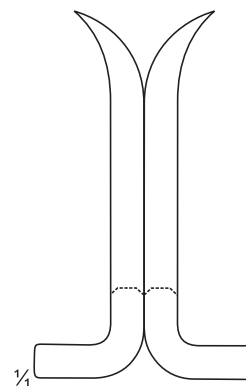
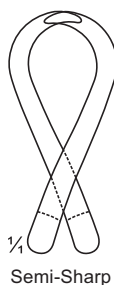
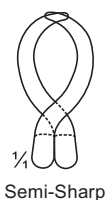
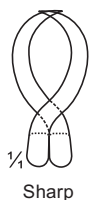

03-5362 - 03-5363
BECKMANN-ADSON
Sharp
310 mm



03-5363
BECKMANN-ADSON
Semi-Sharp
310 mm



03-5364
ADSON
Semi-Sharp
320 mm



03-5365
BECKMANN-EATON
Sharp
320 mm

Special Retractors



1/2

03-5366
JOLL (FRIEDMAN)
 Thyroid- and Vaginal Retractor
 155 mm

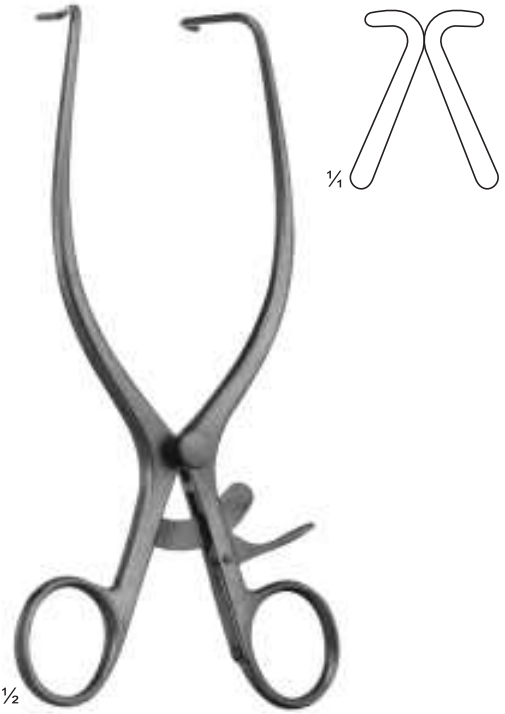

1/2

03-5367
JACKSON BURROWS
 Retractor, blunt
 185 mm

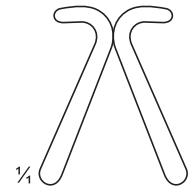

1/4

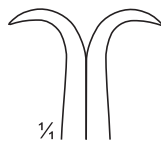

1/4

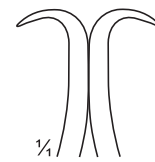

1/4

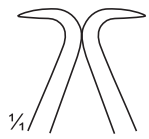

1/4



1/2

03-5368
GELPI
 Vaginal Retractor
 135 mm



1/2

03-5369
GELPI
 Skin- and Vaginal Retractor
 175 mm



1/2

03-5370
DE BAKEY
 Femur Retractor
 145 mm

Self Retaining Retractors for Laminectomy and other Operations

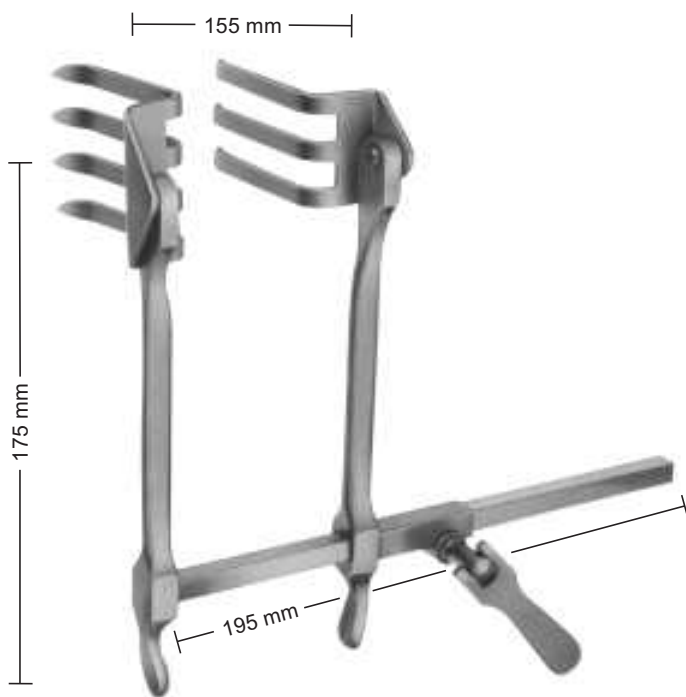

03-5371
 SCOVILLE-RICHTER
 Retractor with 1 pair
 blades reversible type.
 The Retractor bar and shanks
 may be easily rotated 180° when
 blades are in situ.



03-5372
 62 x 52 mm 62 x 37 mm
 PR= Pair



03-5373
 47 x 51 mm



03-5374
 30 x 40 mm



03-5375
 37 x 62 mm

Retractors for Cervical Spine



03-5376
CLOWARD modif.
Spreader Only
Consisting of:
Spreader Only
03-5377 1 Blade
03-5378 1 Blade
03-5379 1 Blade
03-5380 1 Blade
03-5381 1 Blade

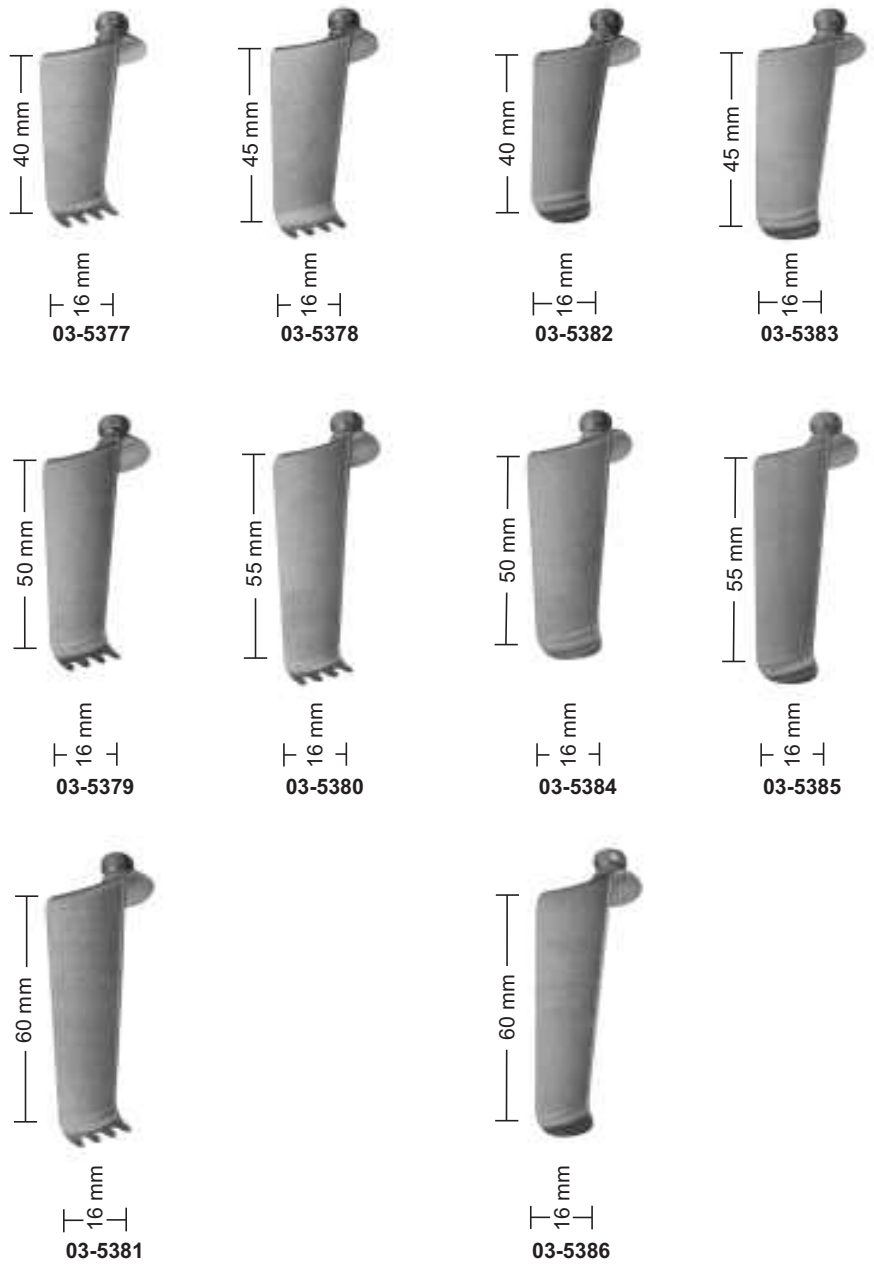

Blades only used for **03-5376**

Retractors for Cervical Vertebral Column

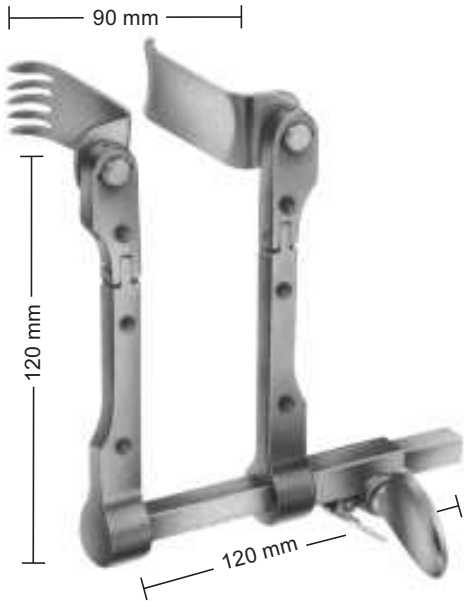

03-5387
CASPAR
Retractor, adjustable, consisting of:
5 medial blades (03-5389 - 03-5393) 5 Lateral
blades. (03-5394 - 03-5398) and the retractor
only By Reversing the Screw,
The Retractor Can be Used From Both Sides

To be used preferably for transverse retraction.

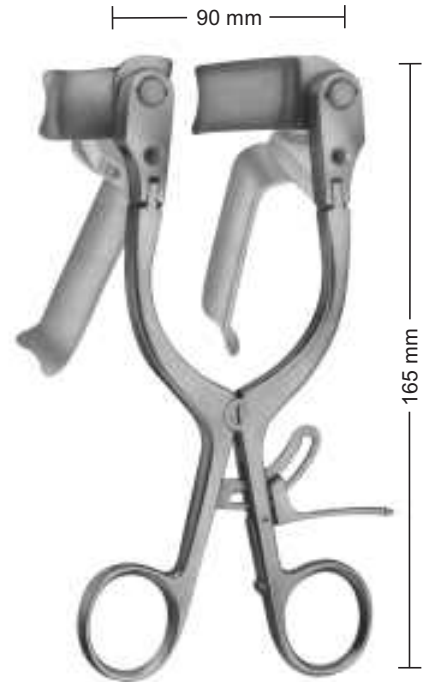

03-5388
CASPAR
Counter retractor, adjustable,
consisting of: 5 blades. (03-5399 - 03-5403)
and the retractor only

To be used preferably for
up and down retraction.



03-5389 40 x 23 mm
03-5390 45 x 23 mm
03-5391 50 x 23 mm
03-5392 55 x 23 mm
03-5393 60 x 23 mm
Medial blades

03-5394 40 x 23 mm
03-5395 45 x 23 mm
03-5396 50 x 23 mm
03-5397 55 x 23 mm
03-5398 60 x 23 mm
Lateral blades

03-5399 45 x 23 mm
03-5400 50 x 23 mm
03-5401 55 x 23 mm
03-5402 60 x 23 mm
03-5403 65 x 23 mm
Blunt blades

03-5404 50 x 25 mm
03-5405 60 x 25 mm
Blunt blades,
for harvesting of the
fusion graft from the
iliac crest

03-5406 40 x 25 mm
03-5407 45 x 25 mm
03-5408 50 x 25 mm
03-5409 55 x 25 mm
03-5410 60 x 25 mm
Medial Titan blades
semi transparent to x-ray

03-5411 40 x 25 mm
03-5412 45 x 25 mm
03-5413 50 x 25 mm
03-5414 55 x 25 mm
03-5415 60 x 25 mm
Lateral Titan blades
semi transparent to x-ray

Lamina Spreaders

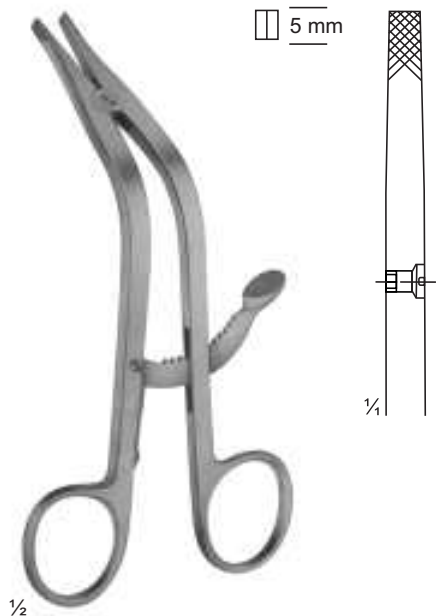

03-5416
CLOWARD
155 mm



03-5417
CLOWARD
135 mm

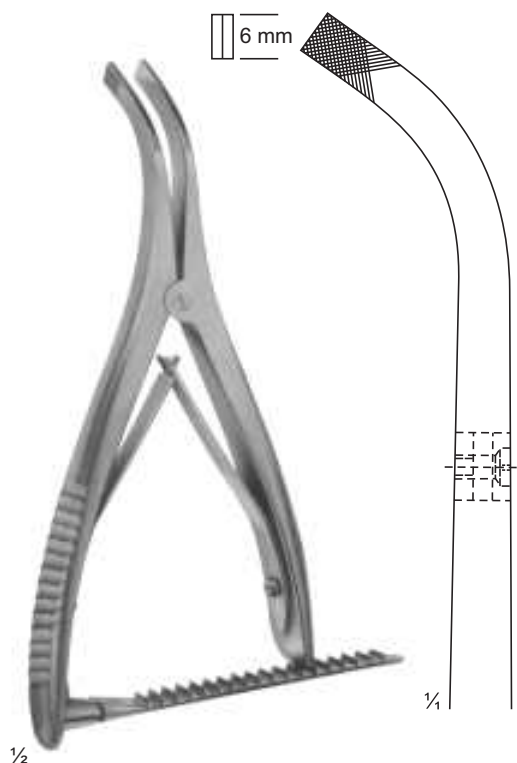

03-5418
INGE
170 mm

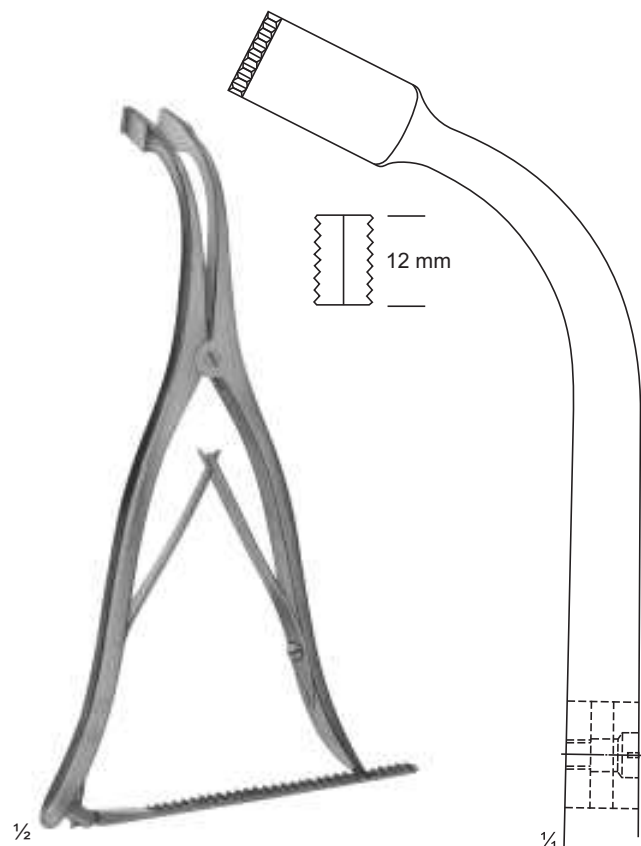

03-5419
INGE
275 mm

Abdominal Retractors

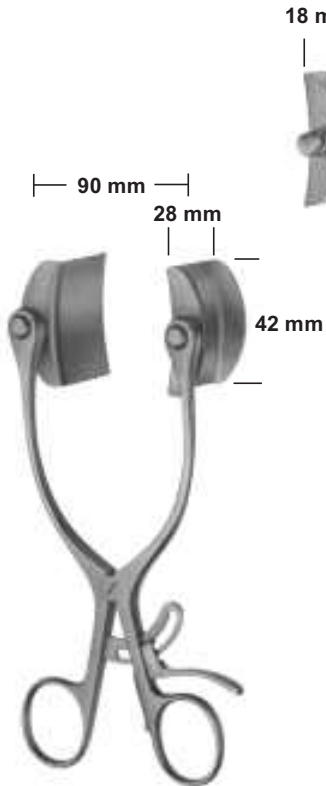

03-5420
BABY-COLLIN
with 2 pair of blades

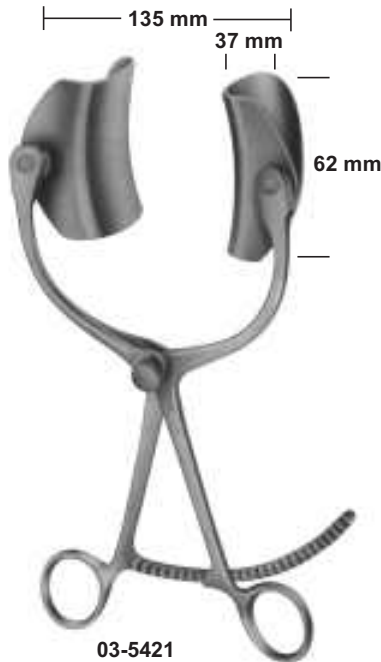
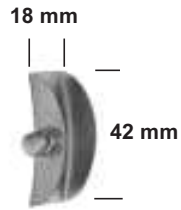

03-5421
COLLIN
complete



03-5422
COLLIN
complete

320 mm

275 mm



03-5423
RICARD
complete

Spreader only
Lateral blade
Center blade



03-5424
HOLZBACH
Complete

Spreader only
Lateral blade 59x80mm
Center blade 74x82mm

Abdominal Baldes

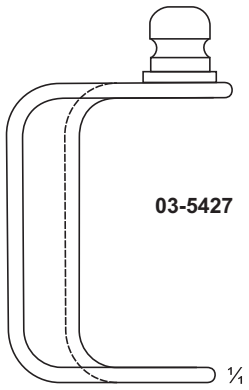

03-5427

Lateral blades only
03-5425 37x62 mm
03-5426 37x80 mm
03-5427 37x98 mm

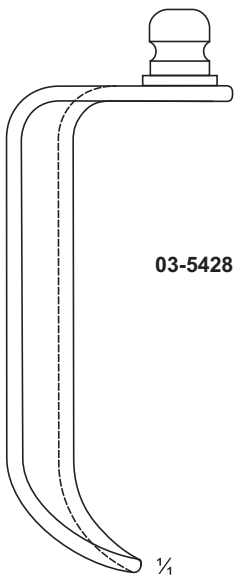

03-5428

03-5428 61x80 mm

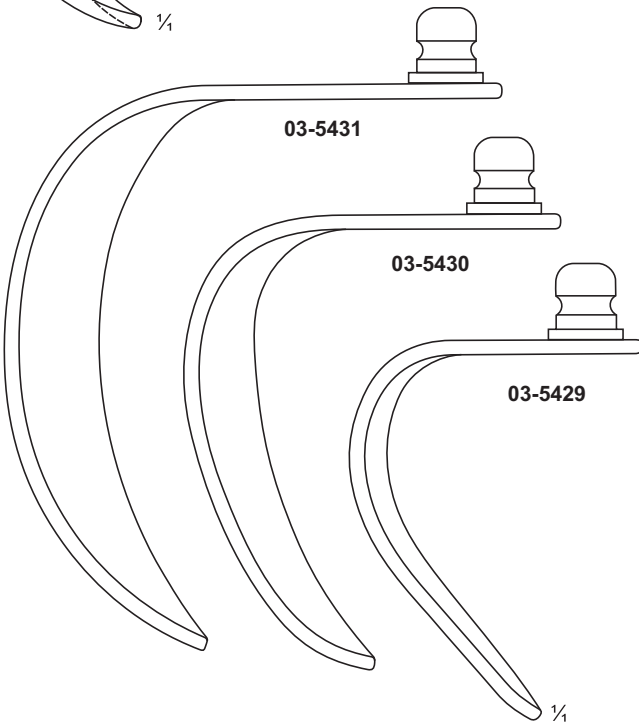

03-5431

03-5430

03-5429

03-5429 48x59 mm
03-5430 58x80 mm
03-5431 72x84 mm

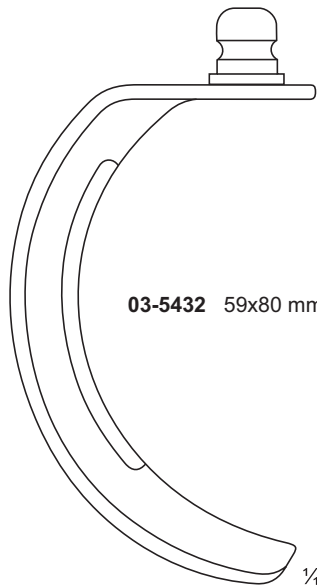

03-5432 59x80 mm



Abdominal Retractors

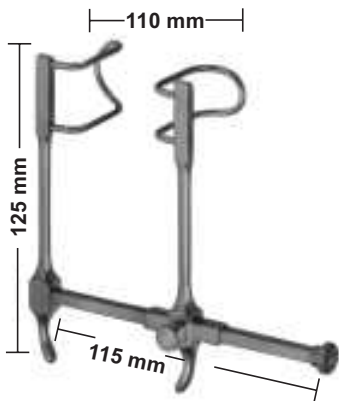

03-5433
GOSSET
Blades: 38 mm deep

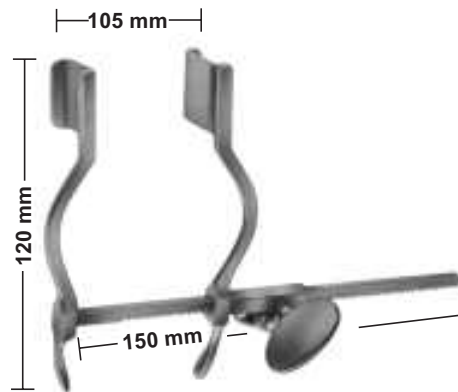

03-5434
HERTZLER
Blades 20 X 25 mm

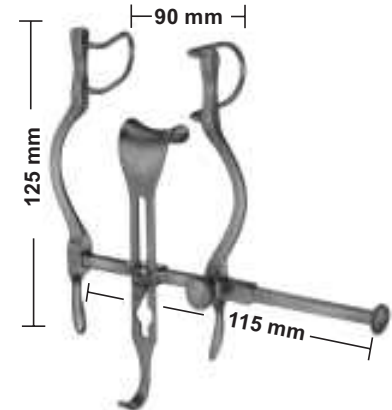

03-5435
BALFOUR-BABY
Lateral blades 27 mm deep
(03-5435) Center blade 21x24 mm

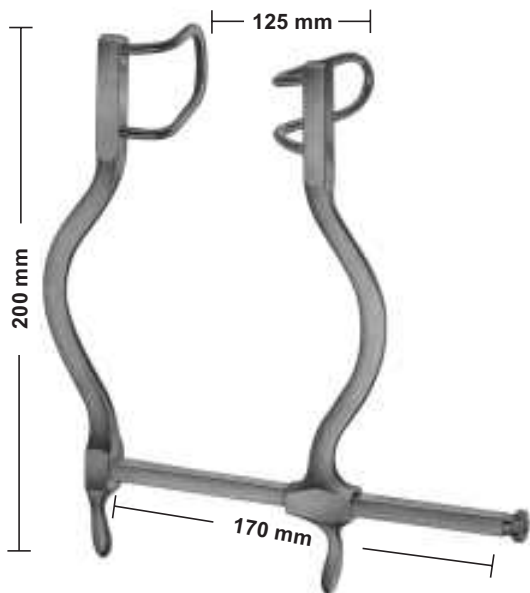

03-5436
GOSSET
Blades: 55mm deep

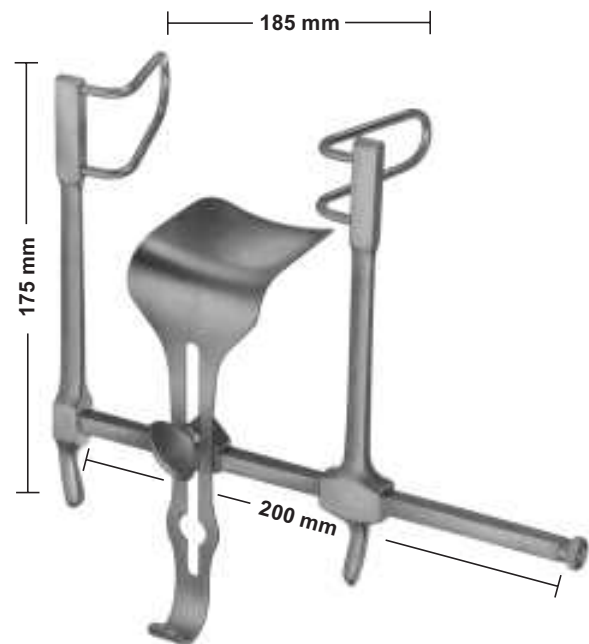

03-5437
GOSSET
Lateral blades 58 mm deep
Center blade
59 x 57 mm

Abdominal Retractors

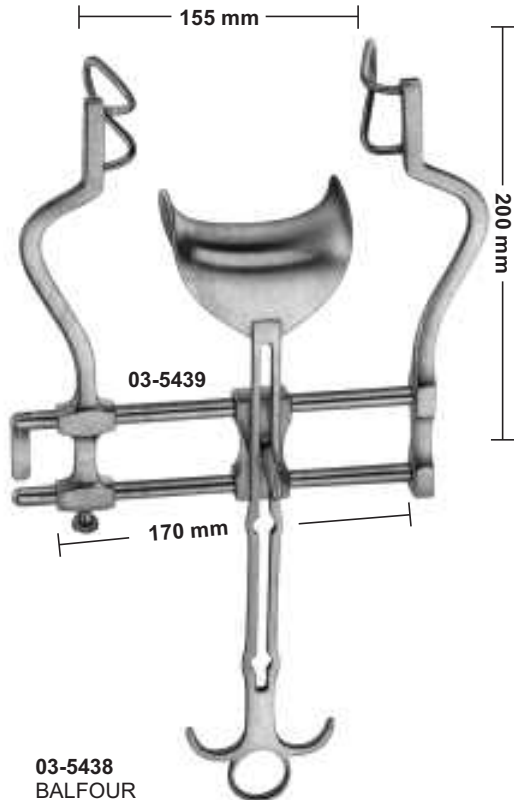

03-5438
BALFOUR
Lateral blades 60 mm deep
(03-5439) Center blade
47 x 80 mm

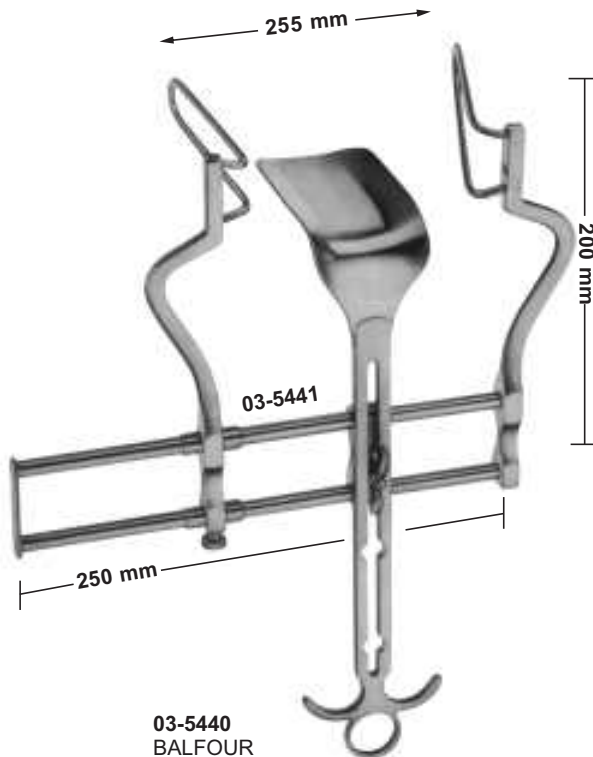

03-5440
BALFOUR
Lateral blades 105 mm deep
(03-5441) Center blade
107x 59 mm



03-5442
Center blade only
54x80 mm

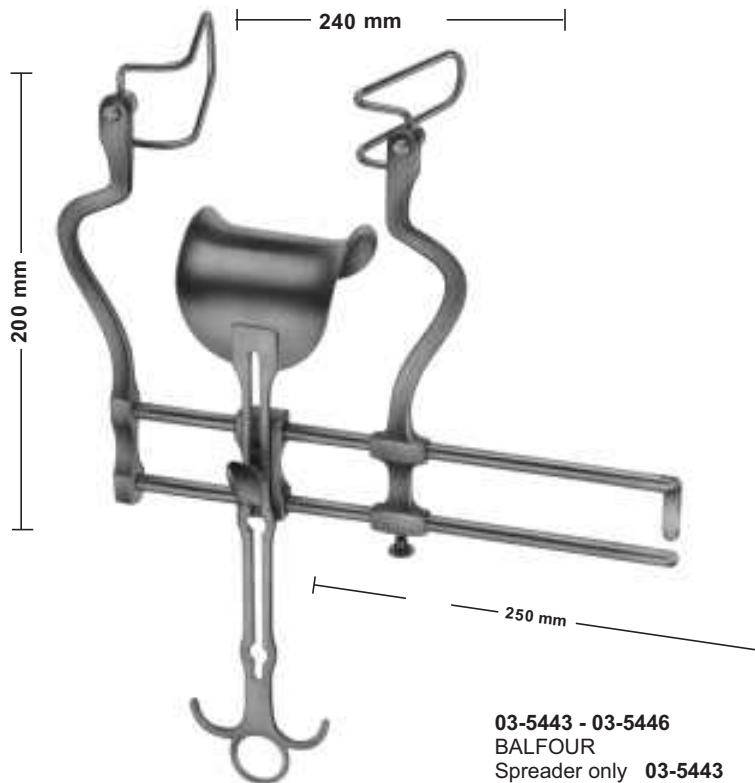

03-5443 - 03-5446
BALFOUR
Spreader only
Lateral blades 50 mm 60 mm 75 mm 90 mm
Center blade 47 x 80 mm 62x76 mm 80x80 mm 80x80 mm



Lateral blades
03-5447 50 mm deep
03-5448 60 mm deep
03-5449 75 mm deep
03-5450 90 mm deep
Sales Unit of blades: PR = pair

Abdominal Retractors

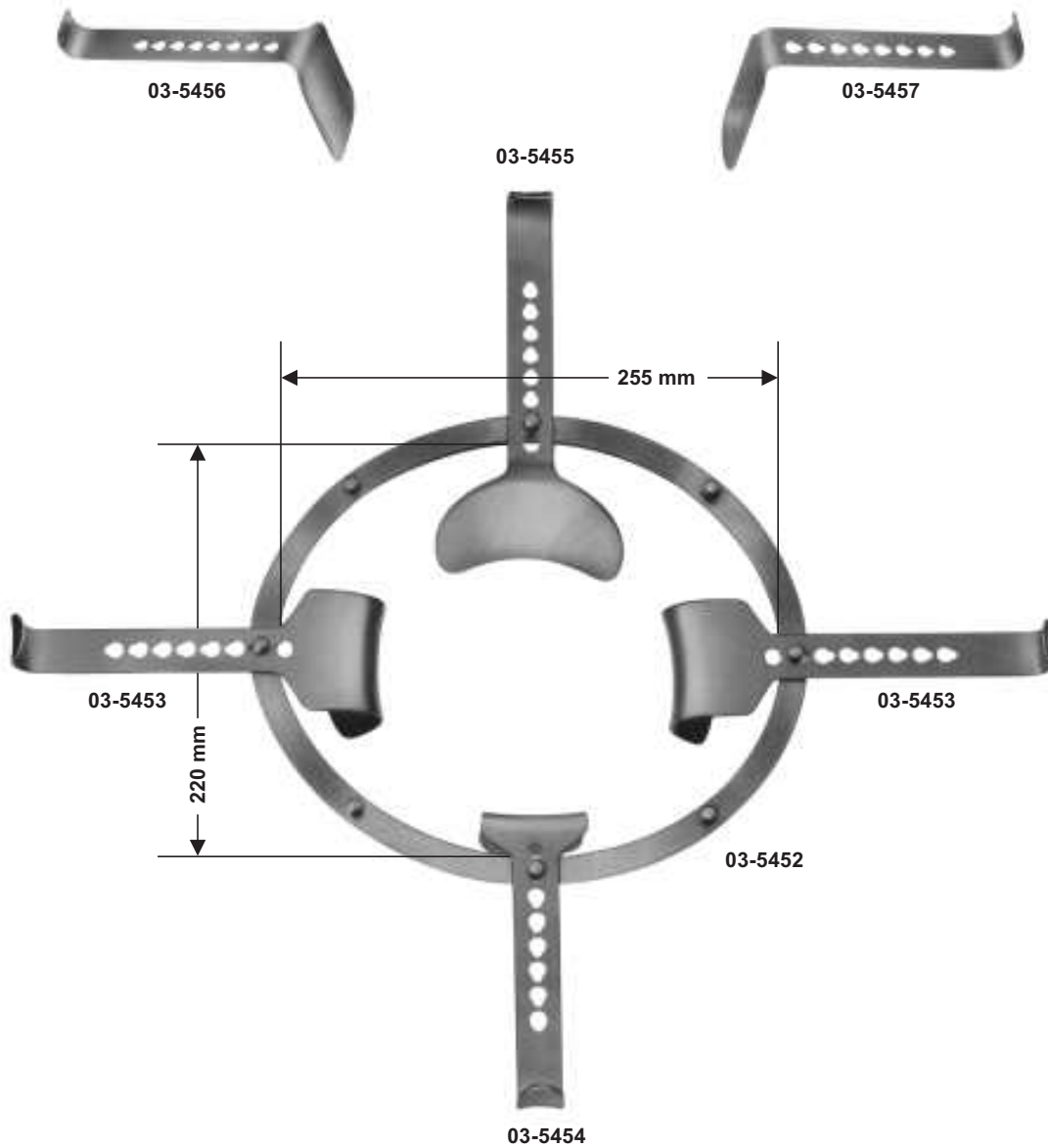

- 03-5451**
SEMM
consisting of:
- 03-5452** 1 frame 225 x 220 mm
 - 03-5453** 2 blades 46 x 64 mm
 - 03-5454** 1 blade 53 x 54 mm
(for bladder)
 - 03-5455** 1 blade 82 x 97 mm
(for intestine)
 - 03-5456** 1 blade 98 x 51 mm
(for intestine)
 - 03-5457** 1 blade, narrow
107 x 36 mm

Abdominal Retractors

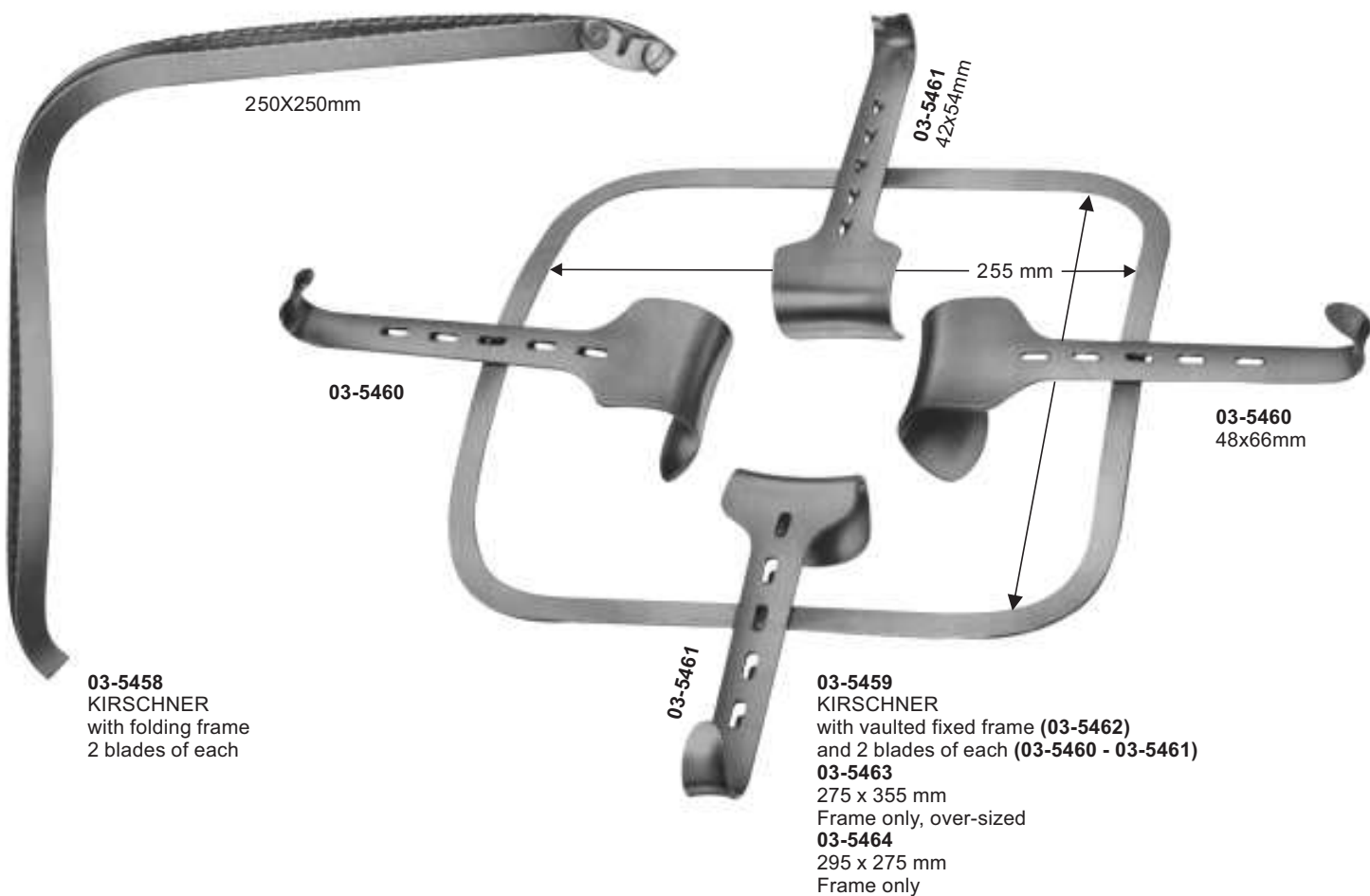

03-5465
KIRSCHNER
64 x 80 mm



03-5466
KIRSCHNER-BALFOUR
80x 82 mm



03-5467 - 03-5469
KIRSCHNER
03-5467 90x 69mm
03-5468 92x 95mm
03-5469 78x 58mm



03-5470 - 03-5472
KIRSCHNER
03-5470 108x42mm
03-5471 91x 55mm
03-5472 121x 55mm

Addition valves for corpulent persons.

Intestinal and Tissue Grasping Forceps

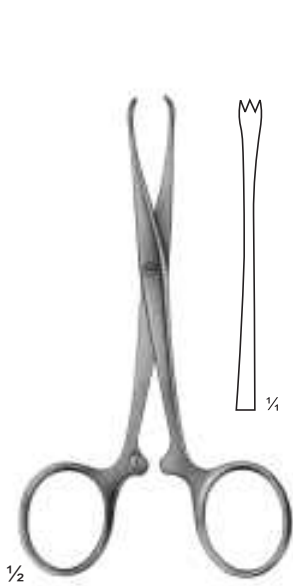

03-5473
CHAPUT
 2 X 3 teeth, sharp
 125 mm,

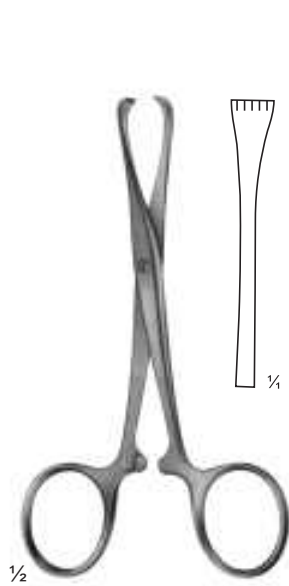

03-5474
TUFFIER
 5 X 6 teeth, sharp
 125 mm,

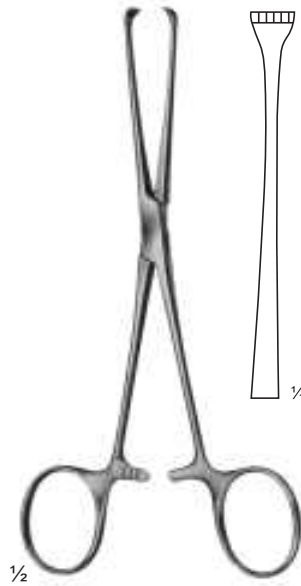

03-5475
BOYS-ALLIS
 5 X 6 teeth, sharp
 155 mm,

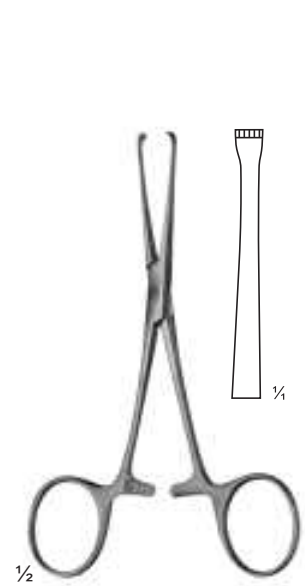

03-5476
BABY-ALLIS
 4 X 5 teeth
 130mm

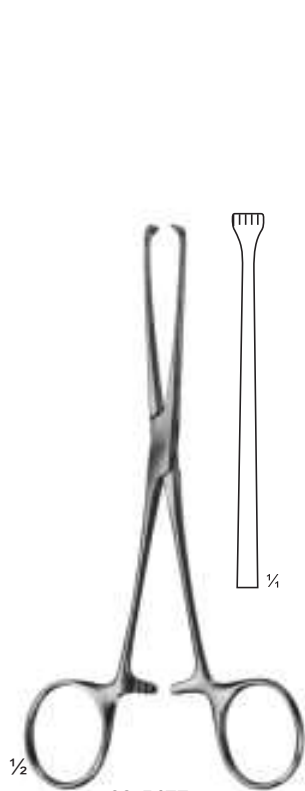

03-5477
ALLIS
 4 X 5 teeth
 155 mm,

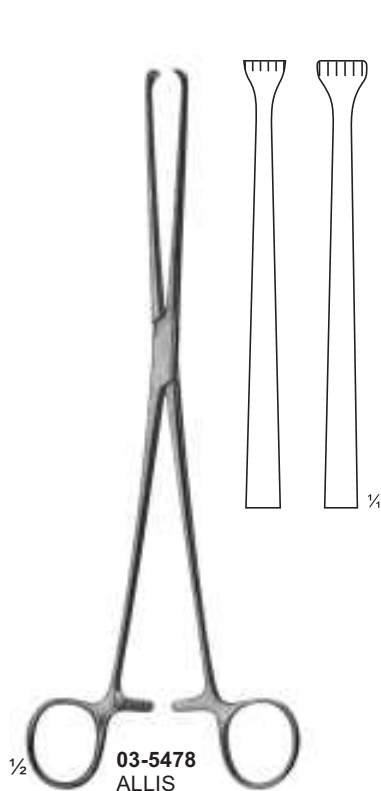

03-5478
ALLIS
 190 mm,
03-5479
 255 mm,
 5 X 6 teeth
 Slender pattern

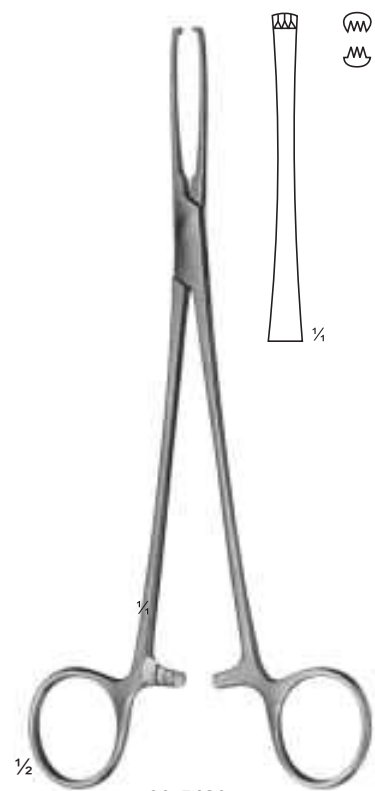

03-5480
JUDD-ALLIS
 3 X 4 teeth
 195 mm,

Intestinal Grasping Forceps

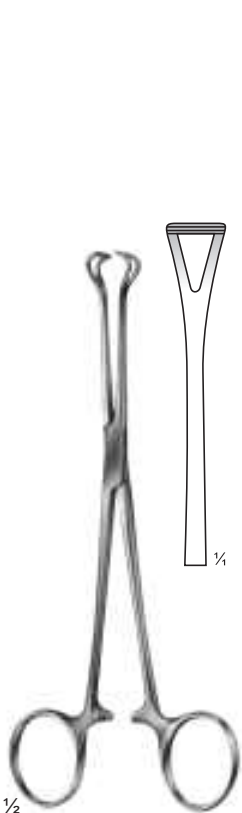

03-5481
BABCOCK
155 mm

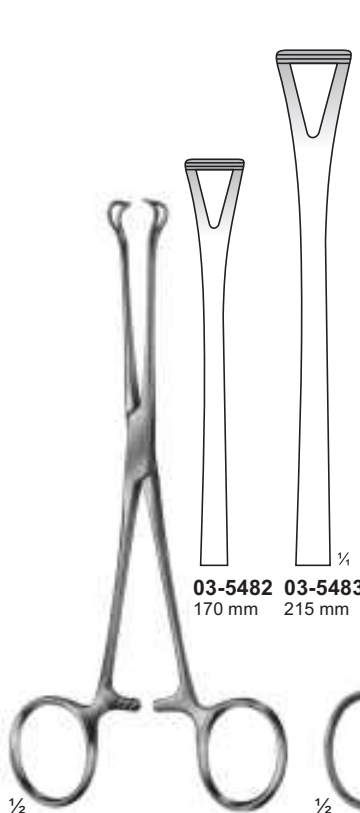

03-5482 03-5483
170 mm 215 mm

03-5482 - 03-5483
BABCOCK

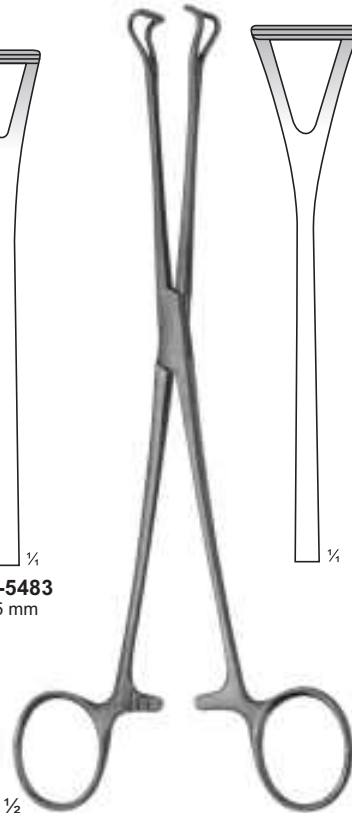

03-5484
BABCOCK
220 mm

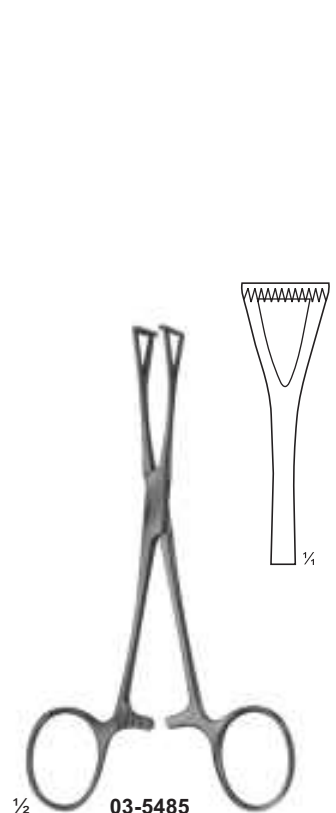

03-5485
COLLIN
140 mm,

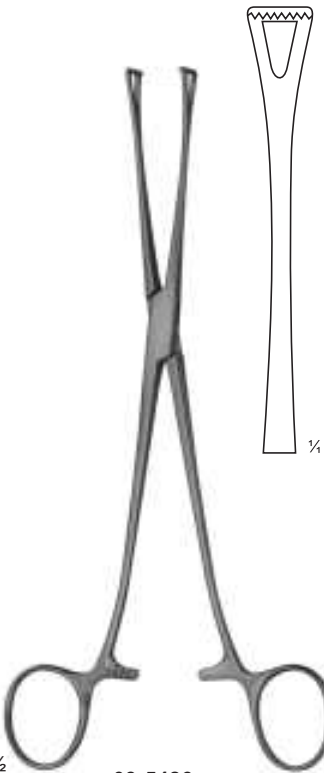

03-5486
LOCKWOOD
200 mm,

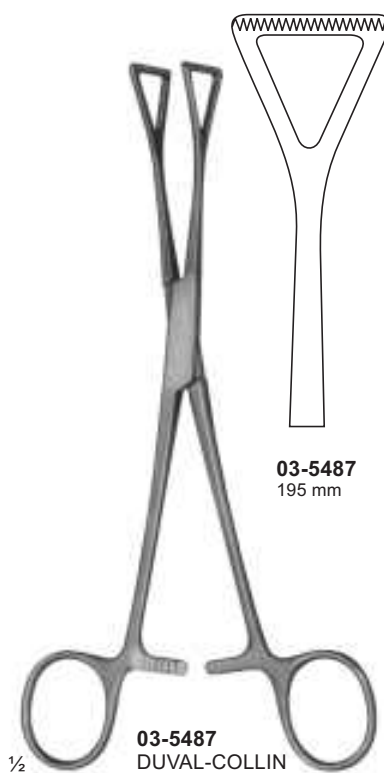

03-5487
195 mm

03-5488
200 mm

03-5487
DUVAL-COLLIN
195 mm
03-5488
200 mm

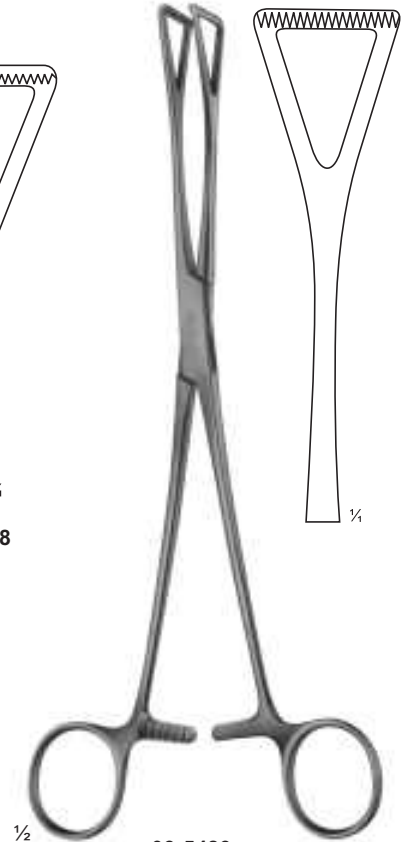

03-5489
DUVAL
230 mm,

Organ - Tissue Grasping, Intestinal and Dissecting Forceps

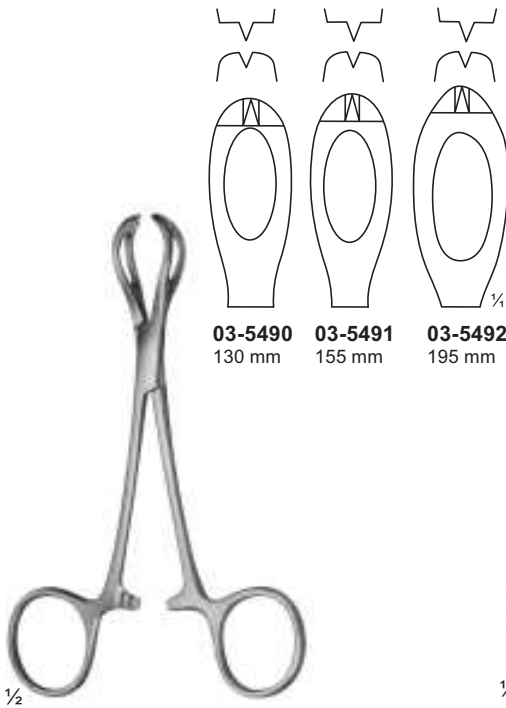

03-5490 130 mm
03-5491 155 mm
03-5492 195 mm

03-5490 - 03-5492
 LANE

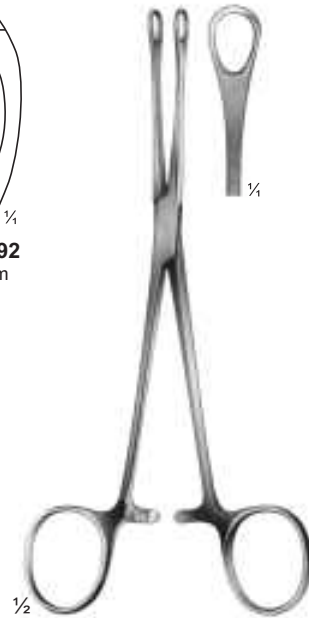

03-5493
 WILLIAMS
 160 mm



03-5494
 DENIS
 BROWNE
 190 mm

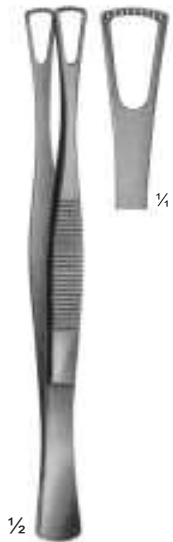

03-5495
 DUVAL
 140 mm



03-5496 **03-5497**
 DUOGRIP

03-5496 - 03-5497
 WANGENSTEEN
03-5496 150 mm
03-5497 230 mm

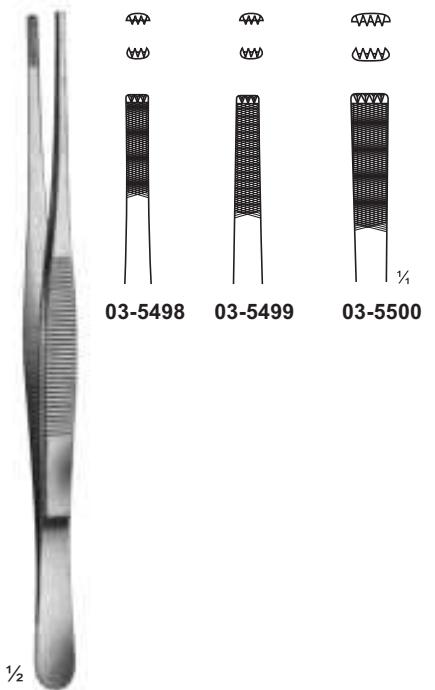

03-5498 - 03-5500
 STILLE-BARRAYA
03-5498 180mm
03-5499 200mm
03-5500 250mm

Organ - Tissue Grasping & Intestinal Forcep ATRAUMATA

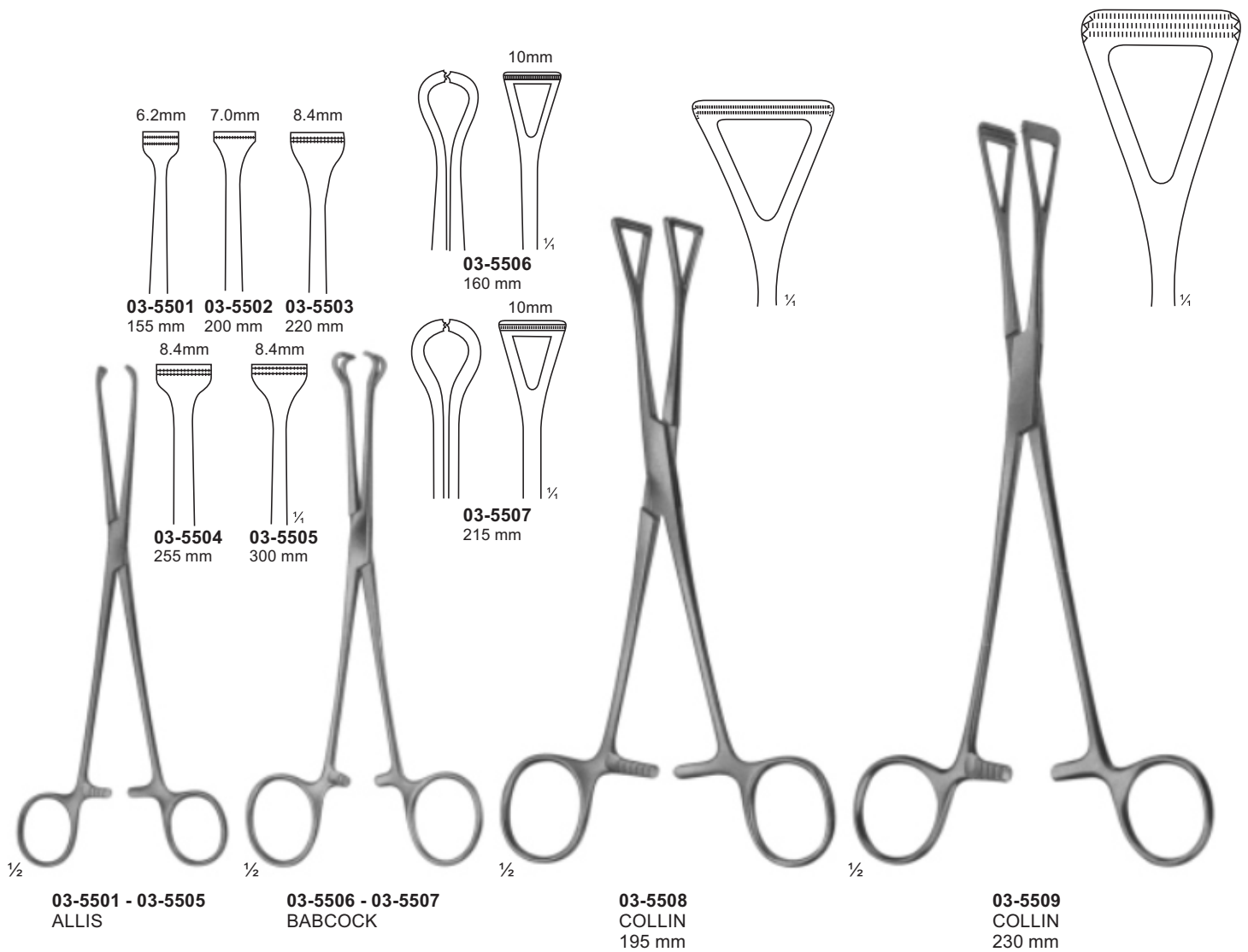

Ultra - Light - Forceps, Dissecting Forceps ATRAUMATA

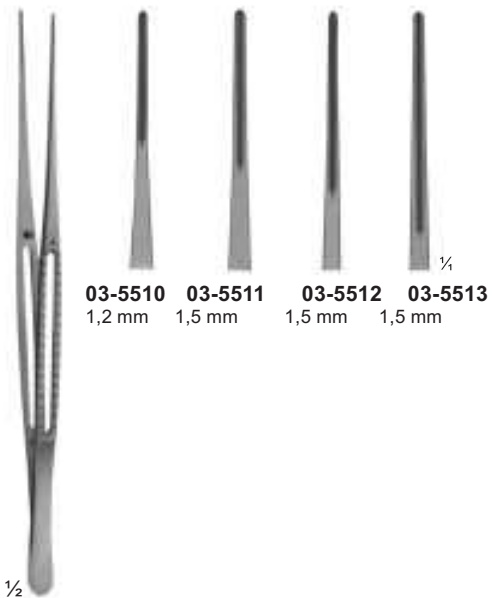

03-5510 1,2 mm
03-5511 1,5 mm
03-5512 1,5 mm
03-5513 1,5 mm

03-5510 - 03-5513
03-5510 150 mm
03-5511 200 mm
03-5512 240 mm
03-5513 300 mm

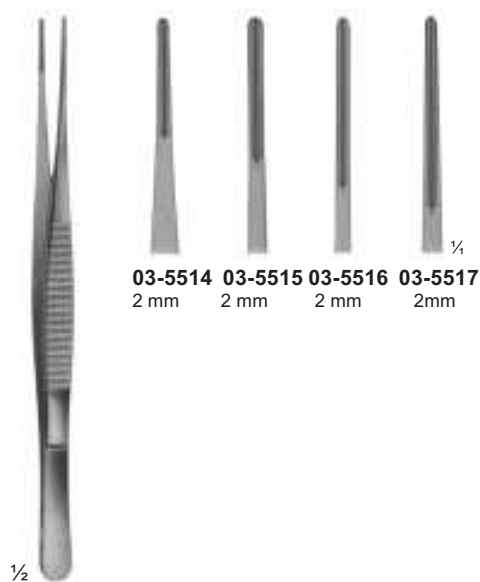

03-5514 2 mm
03-5515 2 mm
03-5516 2 mm
03-5517 2 mm

03-5514 - 03-5517
DE BAKEY
03-5514 150 mm
03-5515 200 mm
03-5516 240 mm
03-5517 300 mm

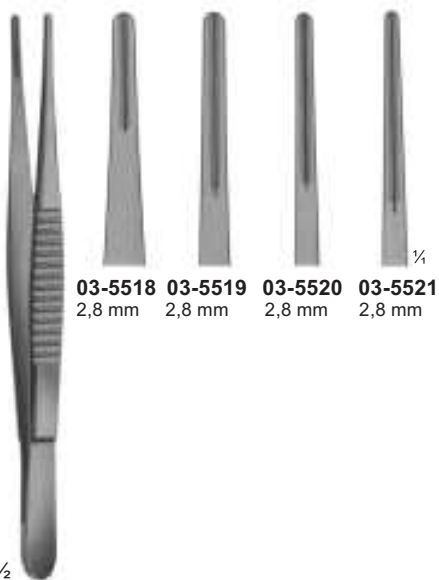

03-5518 2,8 mm
03-5519 2,8 mm
03-5520 2,8 mm
03-5521 2,8 mm

03-5518 - 03-5521
DE BAKEY
03-5518 150 mm
03-5519 200 mm
03-5520 240 mm
03-5521 300 mm

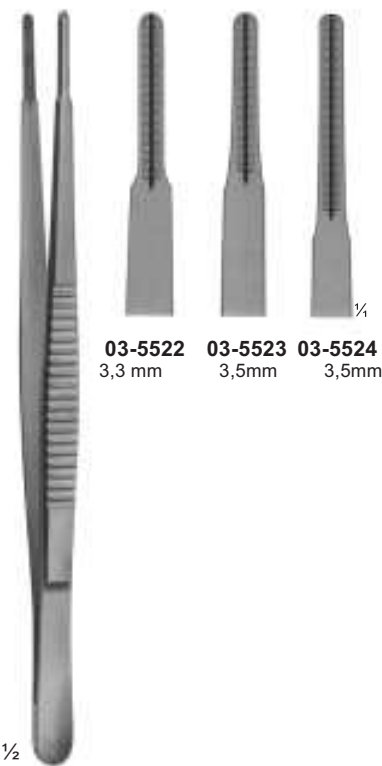

03-5522 3,3 mm
03-5523 3,5 mm
03-5524 3,5 mm

03-5522 - 03-5524
DE BAKEY
03-5522 200 mm
03-5523 240 mm
03-5524 300 mm

Intestinal Clamps for Children



03-5525 - 03-5526
BAINBRIDGE
 155 mm



03-5527
ALLEN
 155 mm

Atraumata



03-5528 - 03-5529
BABY-KOCHER
 very elastic blades
 130 mm

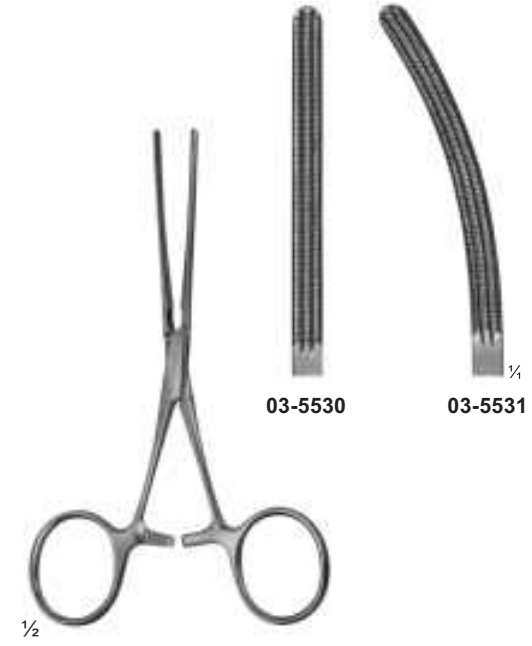

03-5530 - 03-5531
BABY-KOCHER
 with elastic blades
 130 mm

Intestinal Clamps, Soft Elastic

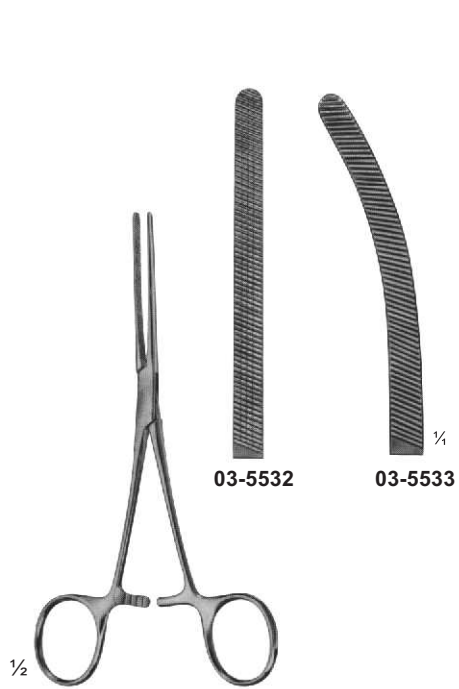

03-5532 - 03-5533
DOYEN
elastic
165 mm

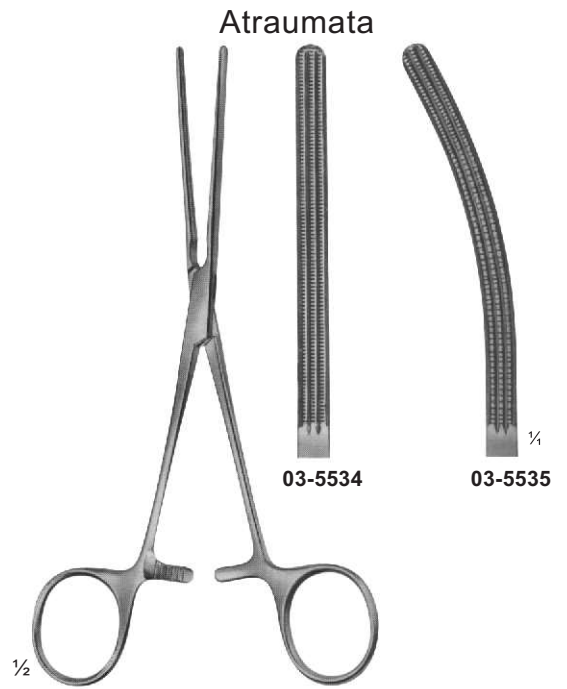

03-5534 - 03-5535
DOYEN
with elastic blades
170 mm

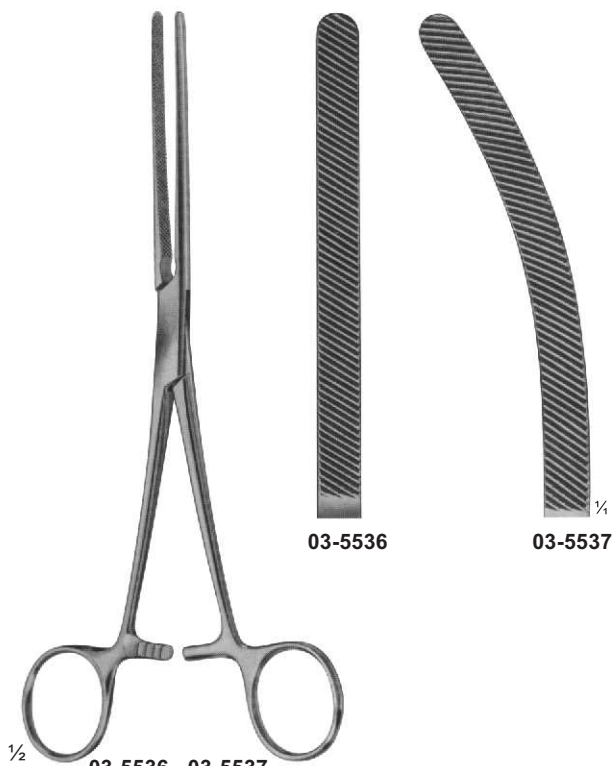

03-5536 - 03-5537
HARTMANN
with elastic blades
200 mm



03-5538 - 03-5539
HARTMANN
with elastic blades
200 mm

Intestinal Clamps, Soft elastic

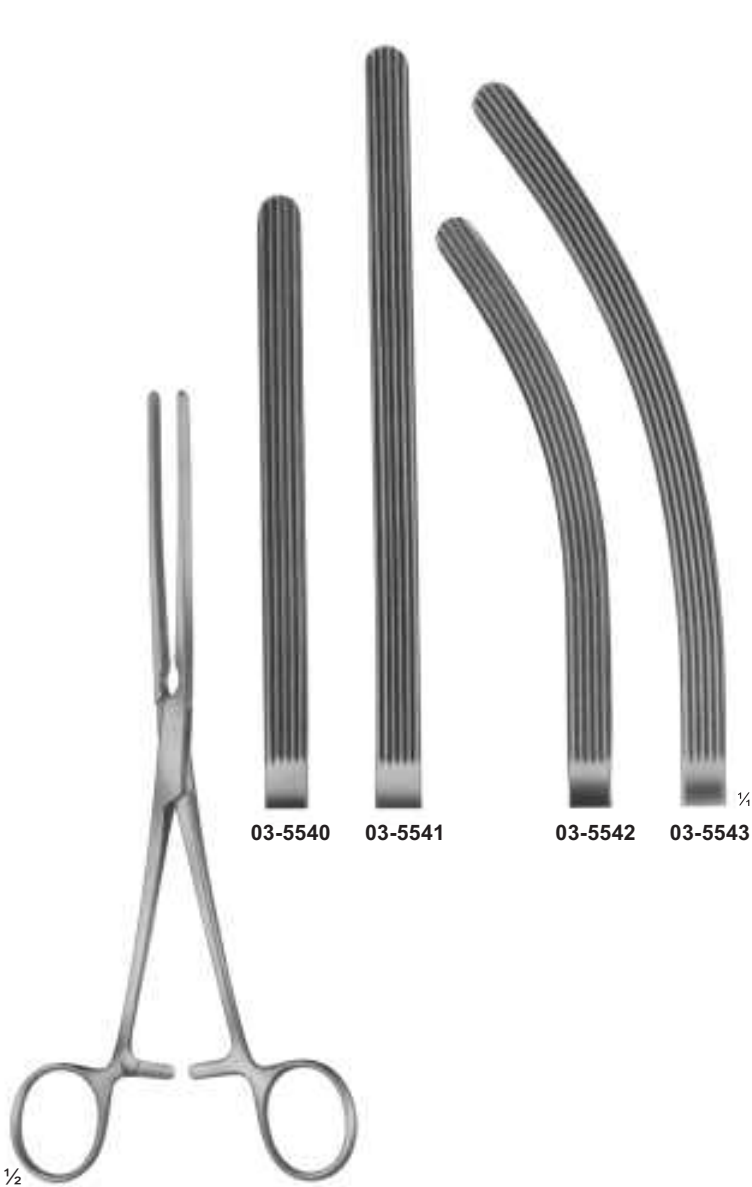

03-5540 - 03-5543
 KOCHER
 with elastic blades
03-5540-03-5542 210 mm
03-5541-03-5543 230 mm

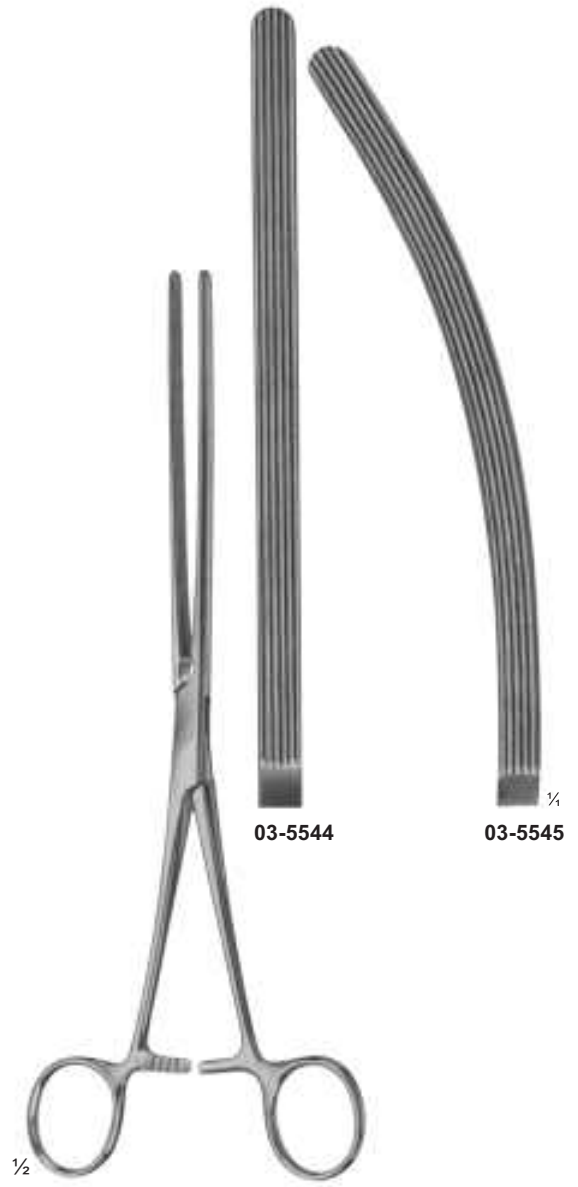

03-5544 - 03-5545
 DOYEN
 with elastic blades
 240 mm

Intestinal Clamps, Soft elastic

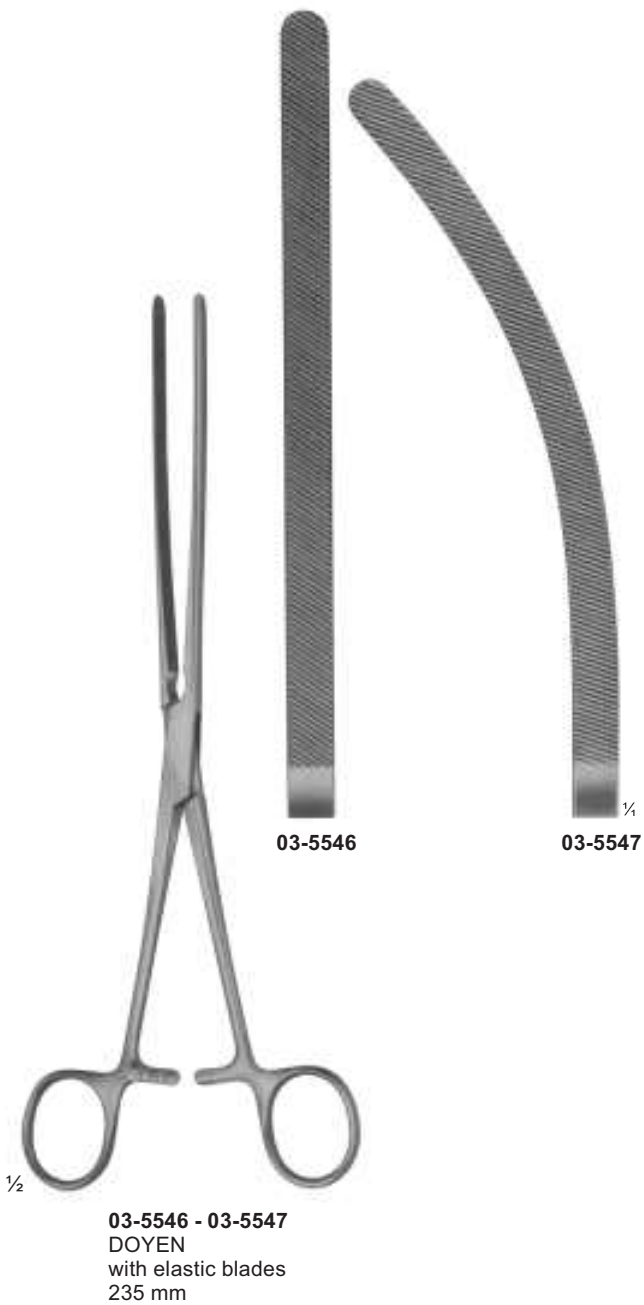

Atraumata



Intestinal Clamps, Soft elastic

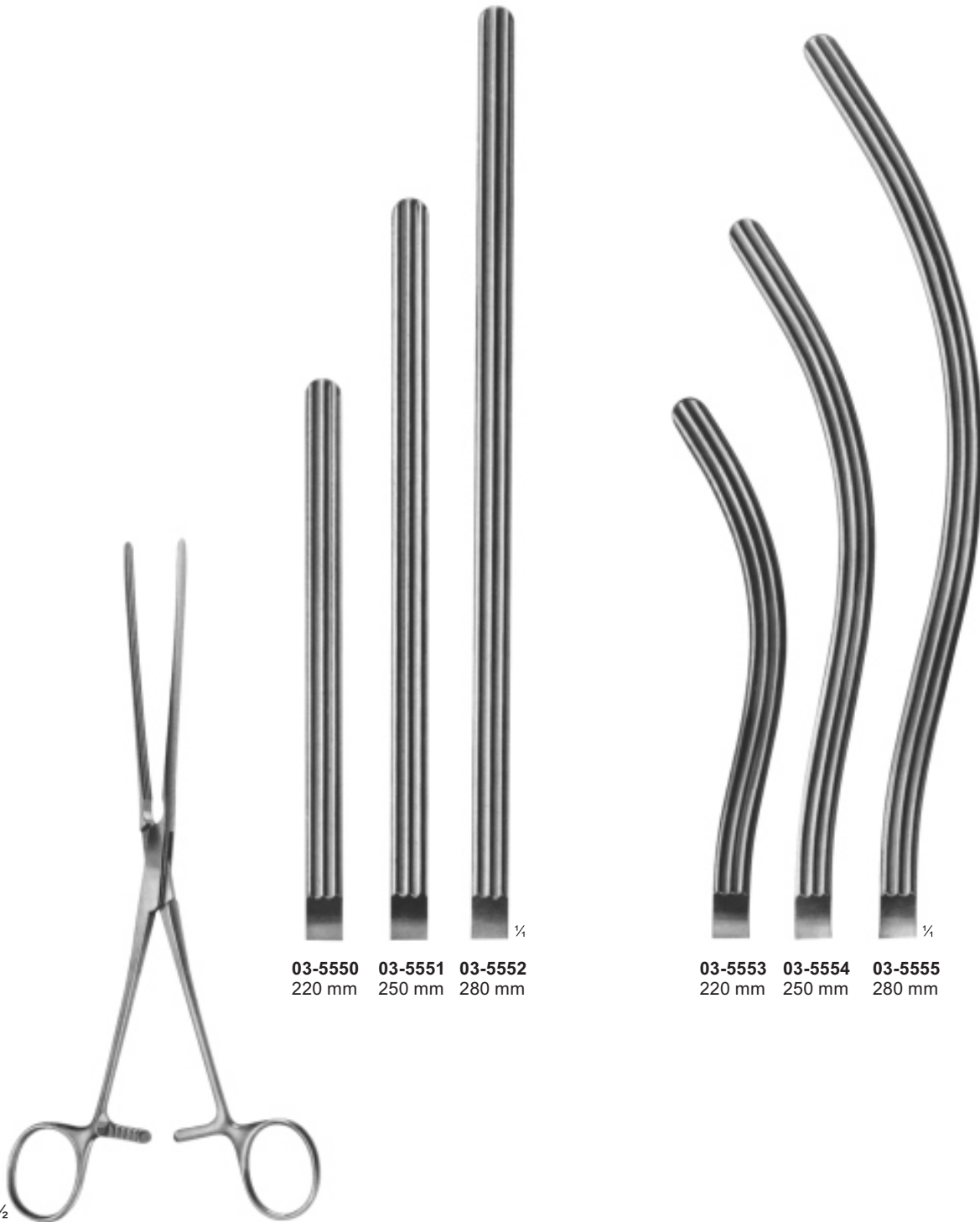

03-5550 220 mm
03-5551 250 mm
03-5552 280 mm

03-5553 220 mm
03-5554 250 mm
03-5555 280 mm

03-5550 - 03-5555
KOCHER
with very elastic blades

Intestinal Clamps, Soft elastic

Atraumata

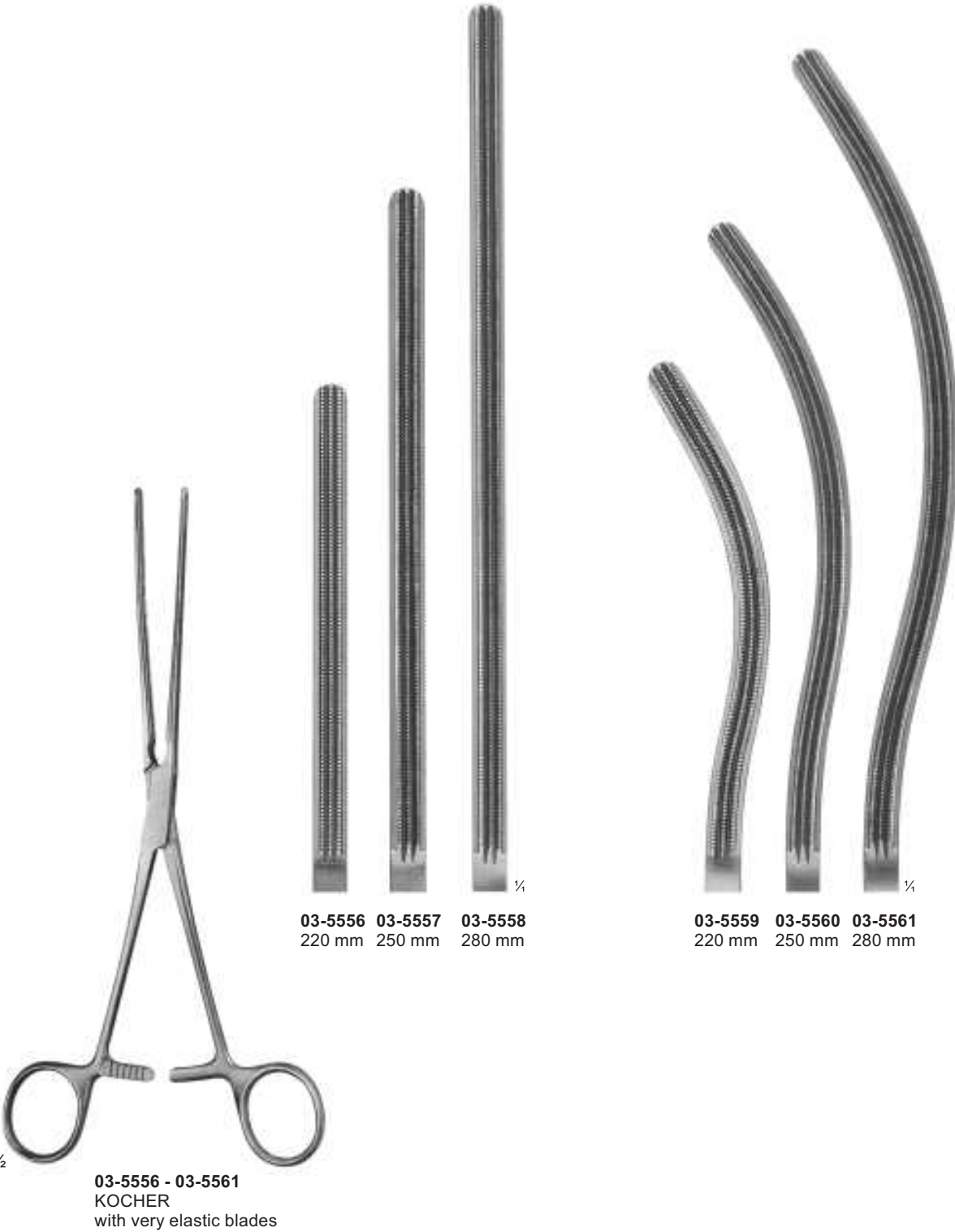

Intestinal Clamps

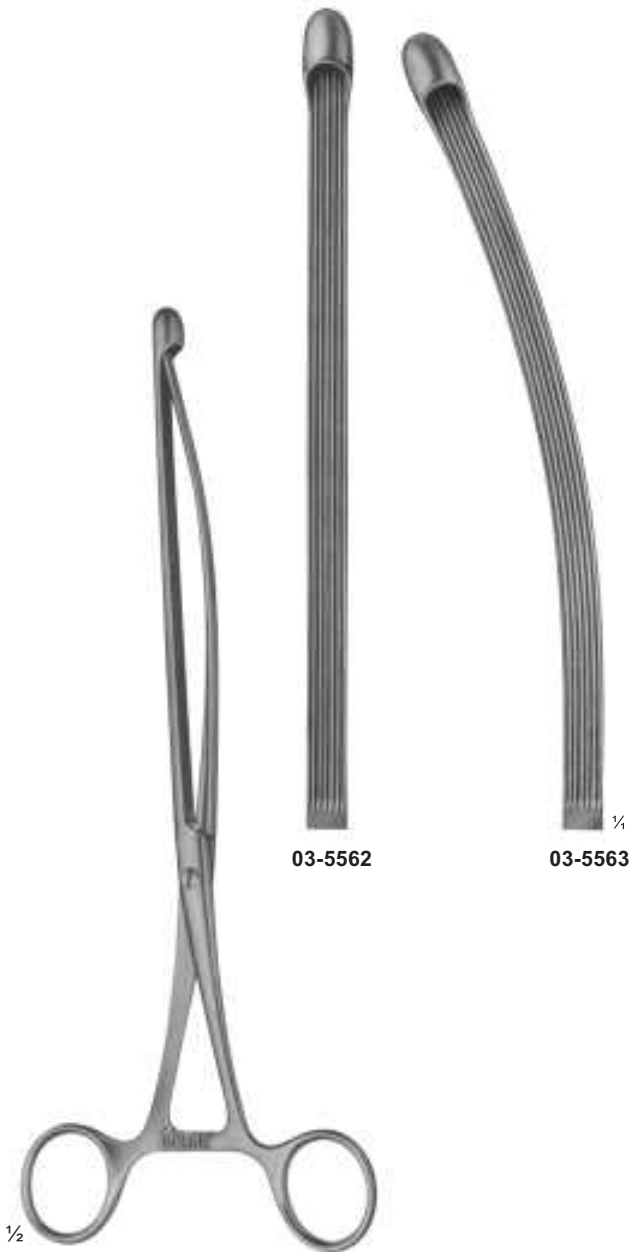

03-5562 - 03-5563
NUSSBAUM
with elastic blades
250 mm

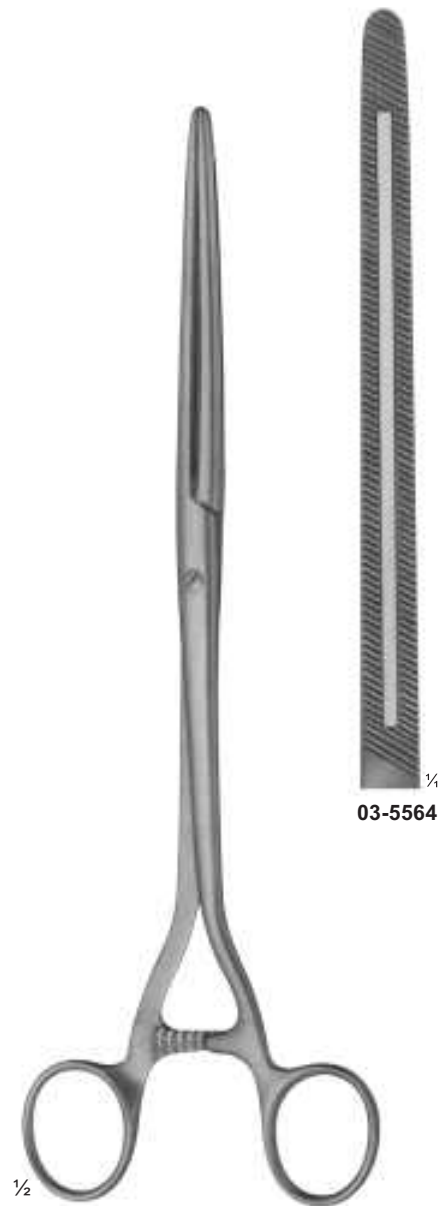

03-5564
MOYNIHAN
280 mm

Atraumata



03-5565

03-5566

1/2

03-5565 - 03-5566
MAYO-ROBSON
hard elastic
250 mm

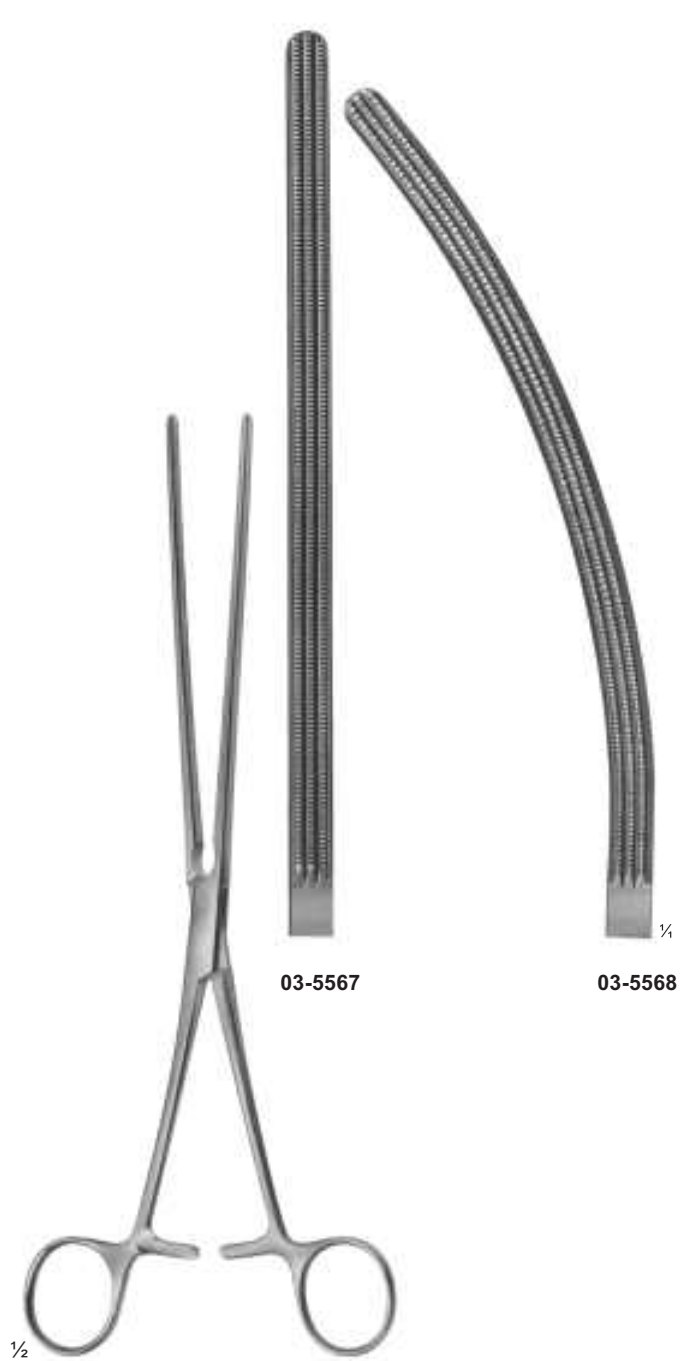

03-5567

03-5568

1/2

03-5567 - 03-5568
MAYO-ROBSON
250 mm

Gastro-Intestinal Forceps, twin



03-5569
LANE
300 mm

03-5570
LANE
300 mm

Stomach Clamps

Atraumata





1/2
03-5574
 PAYR
 Intestinal clamp
 light pattern,
 for children
 180 mm

1/2
03-5575
 PAYR
 200 mm

1/2
03-5576
 PAYR
 275 mm

1/2
03-5577
 PAYR
 Pylorus clamp
 315 mm

Anastomosis Forceps

Atraumata



03-5578
PARKER-KERR
anastomosis forceps
for colon resection
250 mm



03-5579 255 mm
03-5580 265 mm
03-5581 275 mm

03-5579 - 03-5581
DICK
pressure clamps

Sigmoid Anastomosis Forceps



Atraumata Sigmoid Anastomosis Forceps

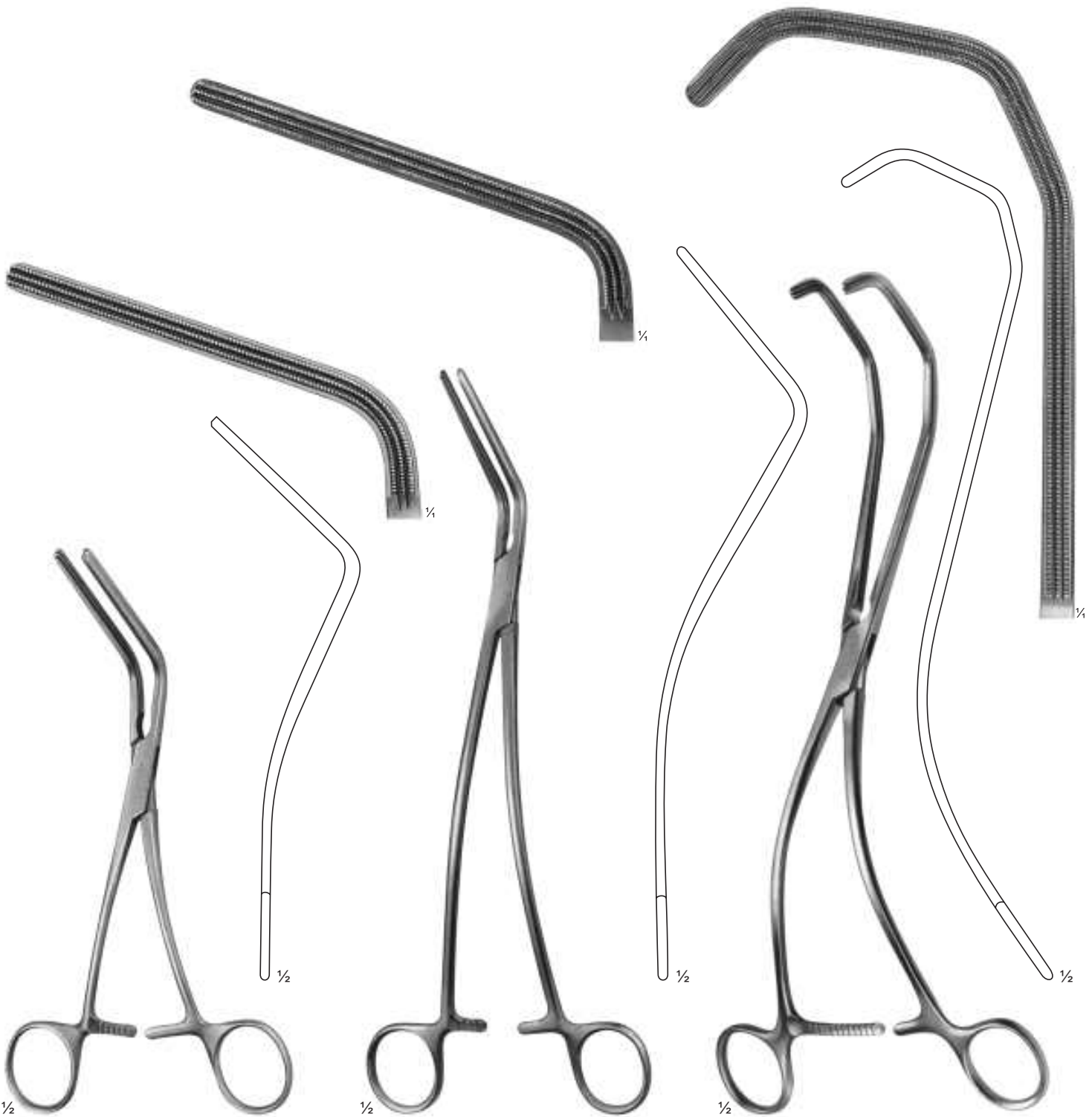

03-5585
MORRIS
175 mm

03-5586
DE BAKEY
(MORRIS modif.)
240 mm

03-5587
KERSTING
270 mm

Rectal Specula

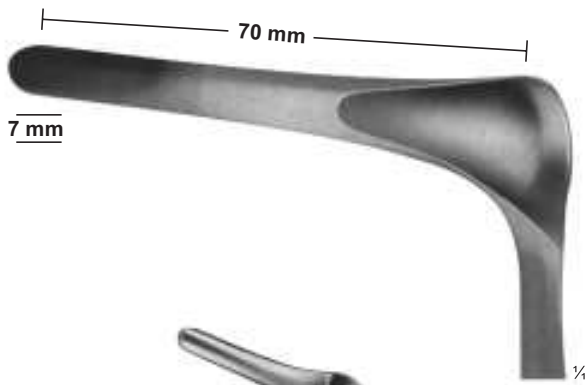

03-5588
KILLIAN
for children
145 mm



03-5589
SIMS
160 mm



03-5590
SIMS
160 mm

Rectal Specula



03-5591 - 03-5594

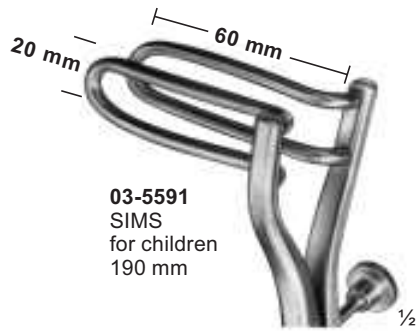

03-5591
SIMS
for children
190 mm

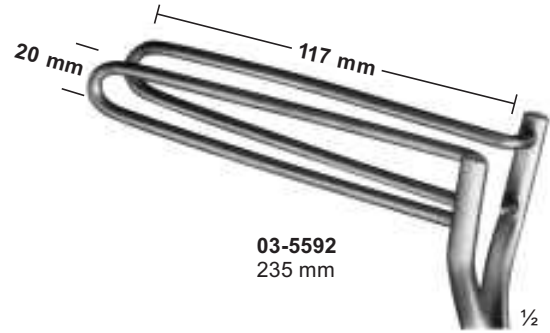

03-5592
235 mm

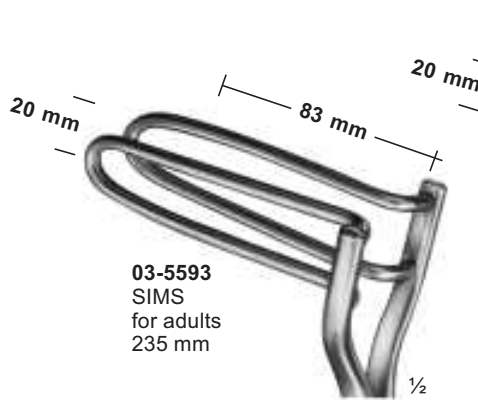

03-5593
SIMS
for adults
235 mm

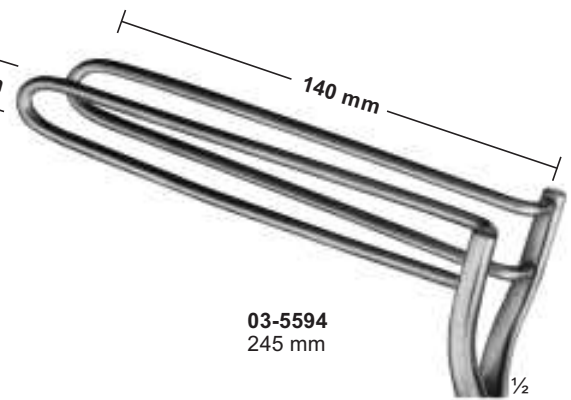

03-5594
245 mm



03-5595
PRATT
205 mm

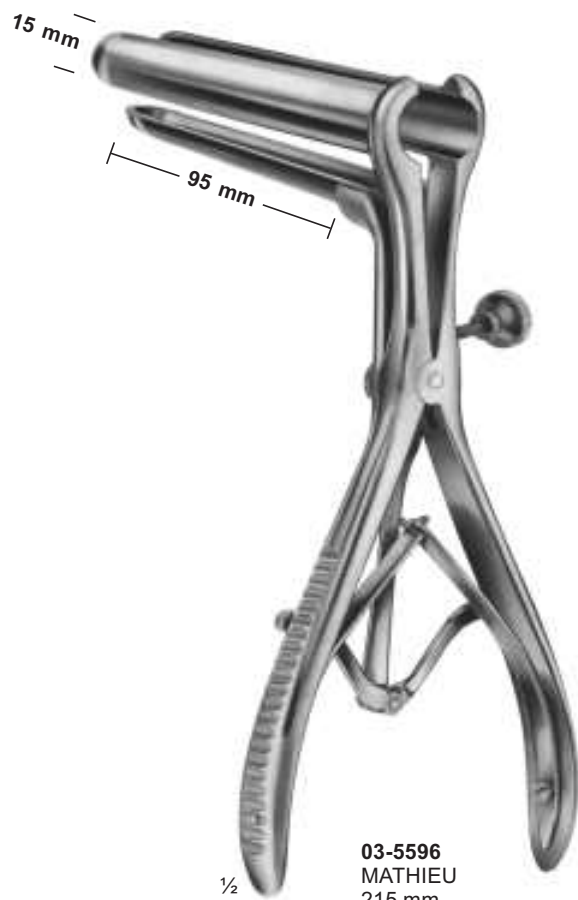

03-5596
MATHIEU
215 mm



1/2
03-5597
 IVES-FANSLER
 Anuscopy
 145 mm
 Ø 24mm



1/2
03-5598
 KELLY
 Sphincteroscope
 160 mm
 Ø 21mm



1/2
03-5599
 KELLY
 Sphincteroscope
 160 mm
 Ø 27mm

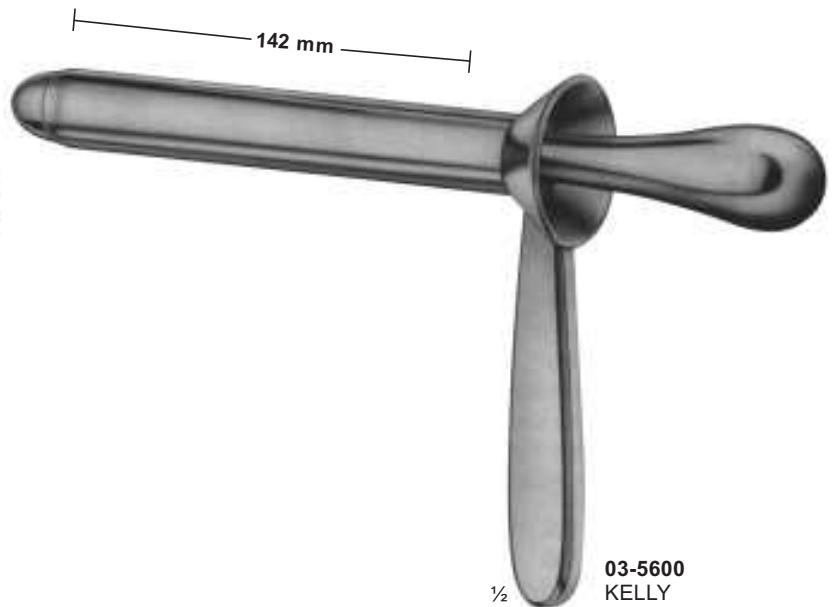

1/2
03-5600
 KELLY
 Proctoscope
 140 mm
 Ø 22mm

Biopsy forceps for rectum

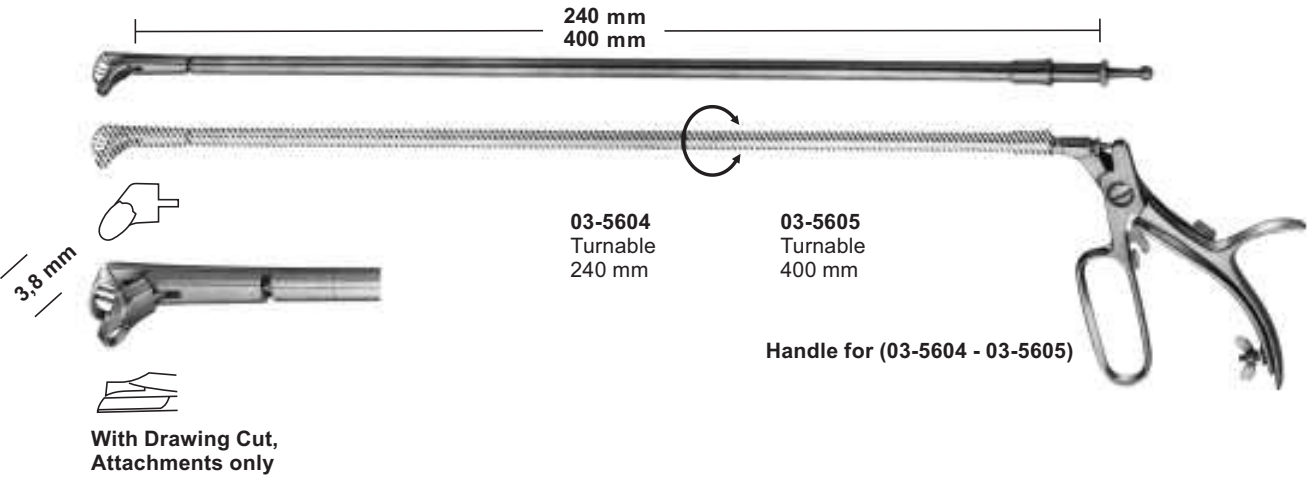
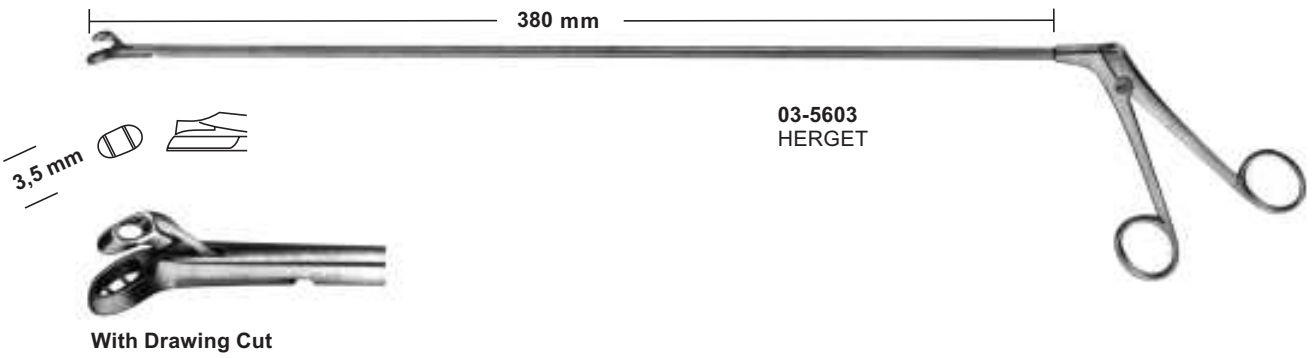
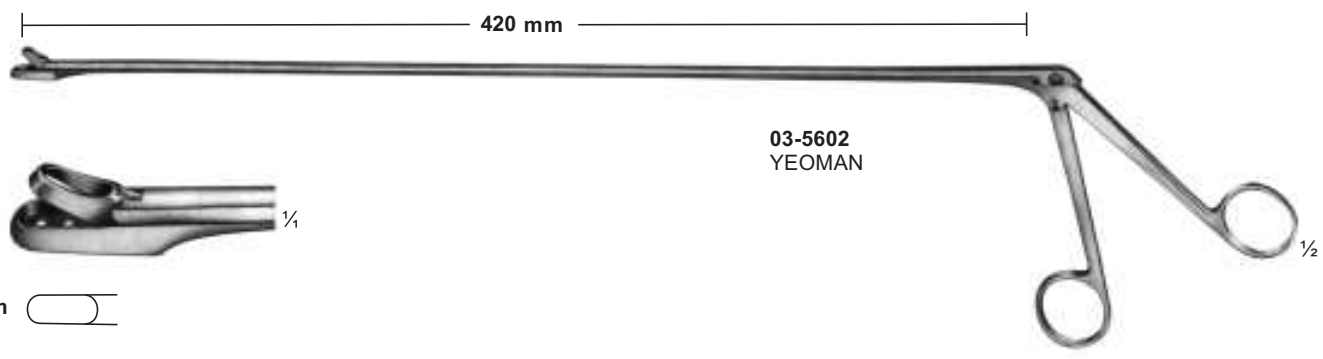
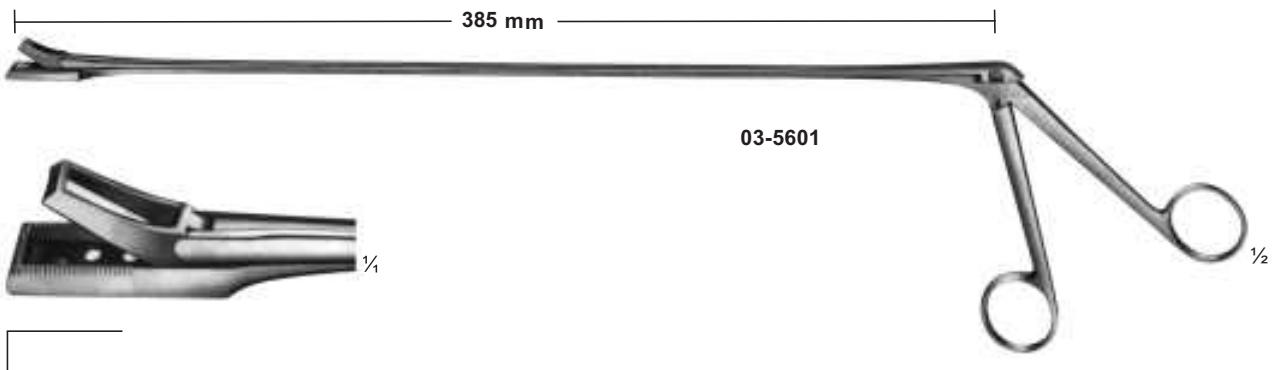

Biopsy Forceps & Swab Holders

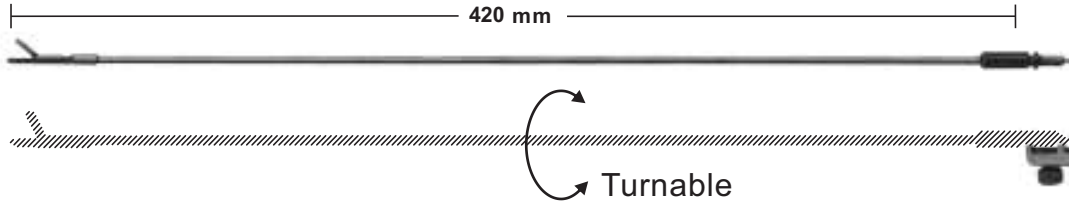

3,5 mm   ¼ 03-5606

3,5 mm   ¼ 03-5607

4,0 mm   ¼ 03-5608

4,0 mm   ¼ 03-5609

Biopsy Forceps

03-5606 - 03-5609
Handle for

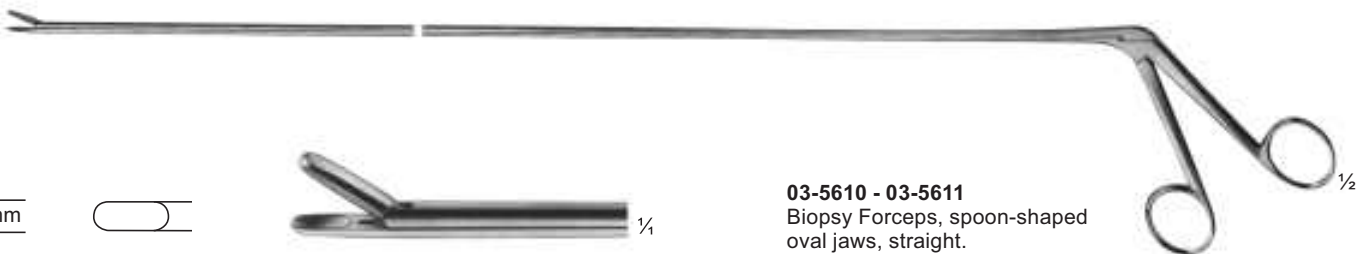

03-5610 - 03-5611
Biopsy Forceps, spoon-shaped
oval jaws, straight.
03-5610 350mm
03-5611 500mm

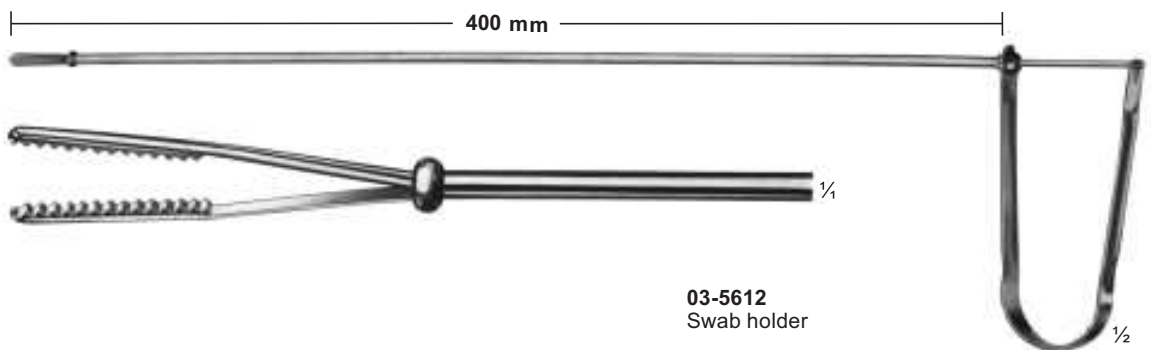

Haemorrhoidal Forceps



03-5613
220 mm

03-5614
245 mm

03-5613 - 03-5614
LUER



03-5615
HEYWOOD-SMITH
200 mm



03-5616
HEYWOOD-SMITH
modif
215 mm

Atraumata



03-5617
250 mm
03-5618
270 mm

Pressure Clamp

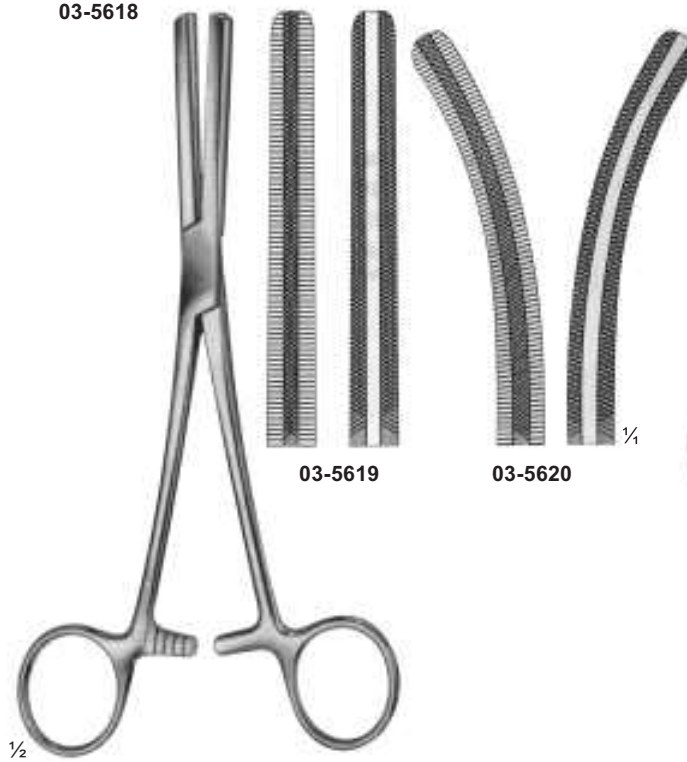

03-5619 - 03-5620
FERGUSSON
200 mm



03-5621
RUDD
Haemorrhoidal ligator
with loading
attachment and 100
ligature rubber rings
315 mm

Gall Duct Forceps



03-5622
LOWER
180 mm



03-5623
LAHEY (SWEET)
190 mm



03-5624
LAHEY
220 mm



03-5625
DESJARDINS
Gall duct-and cystic forceps
210 mm



03-5626
NISSEN
Gall duct-and cystic forceps
215 mm

Gall Duct Forceps and Choledochus Forceps

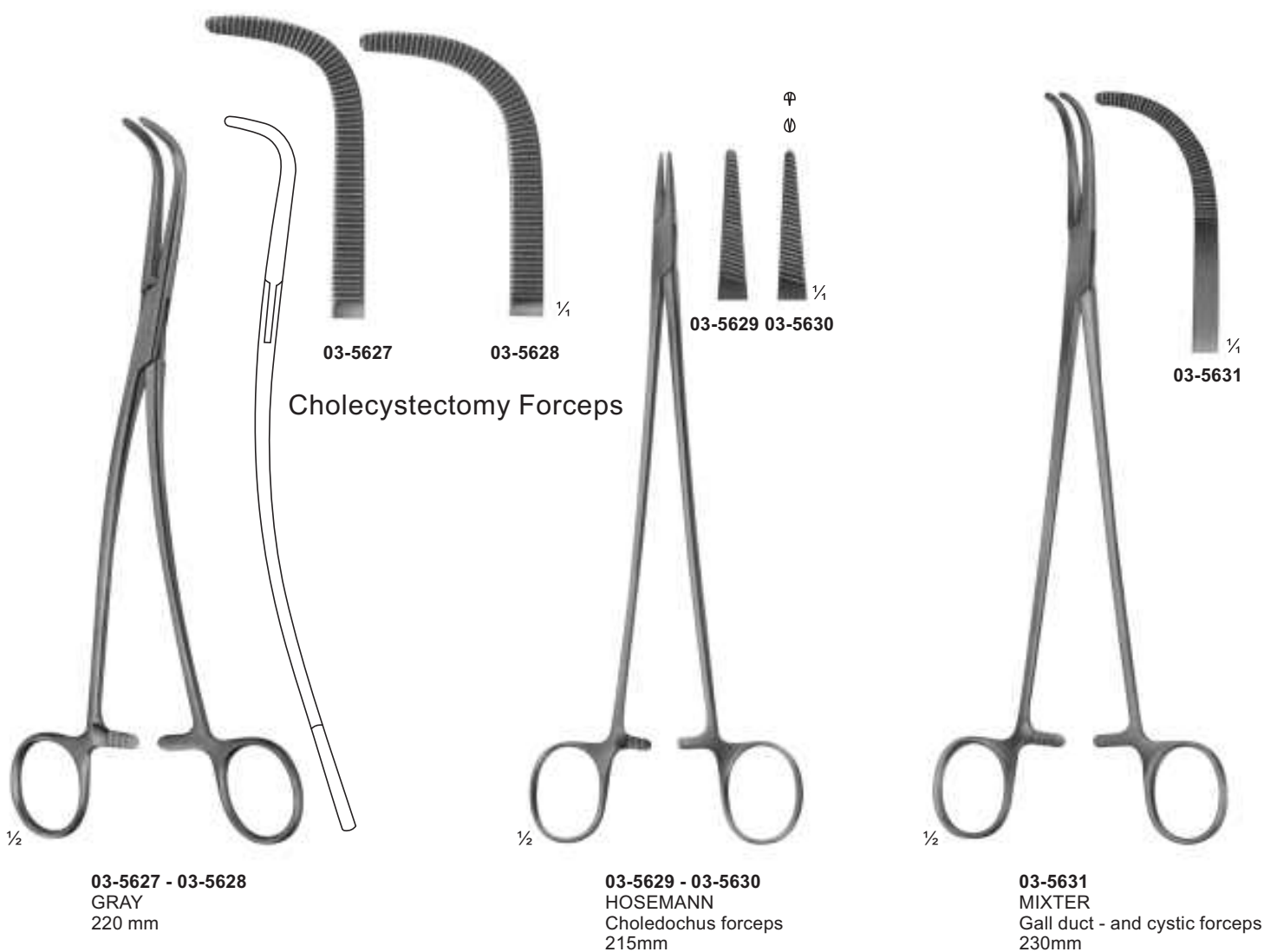

Cholecystectomy Forceps

03-5627 - 03-5628
GRAY
220 mm

03-5629 - 03-5630
HOSEMANN
Choledochus forceps
215mm

03-5631
MIXTER
Gall duct - and cystic forceps
230mm

Gall Bladder Forceps and Gall Duct Scissor

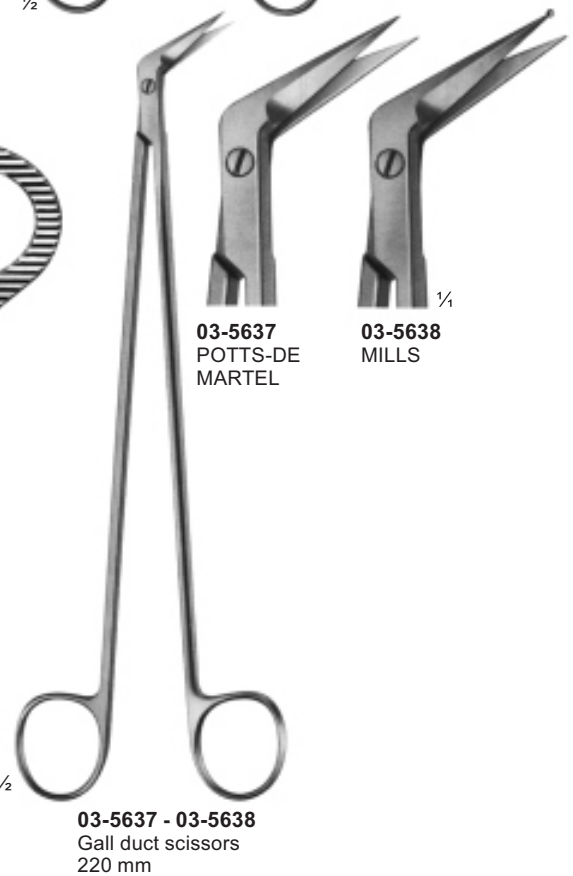
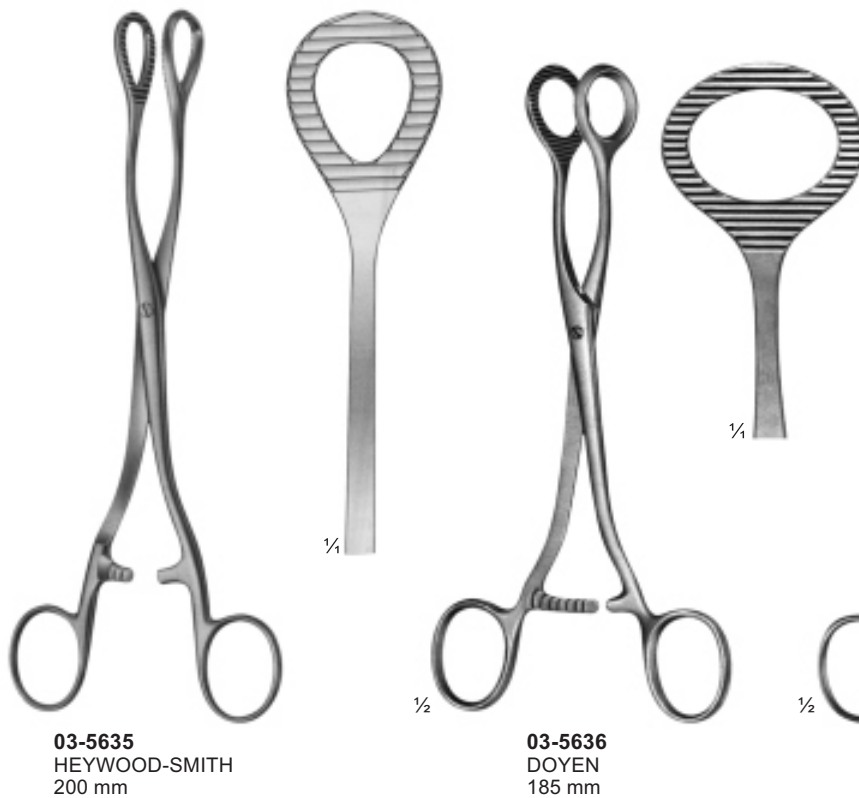
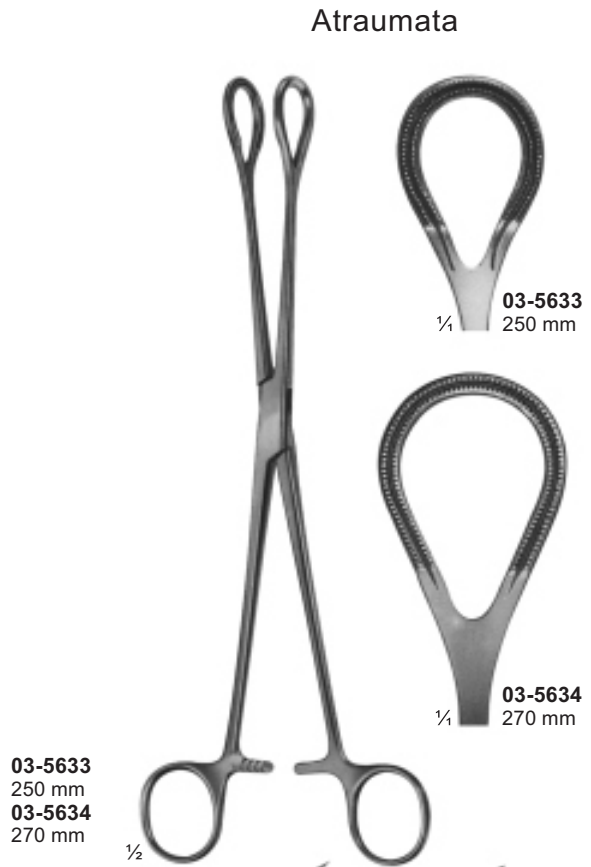
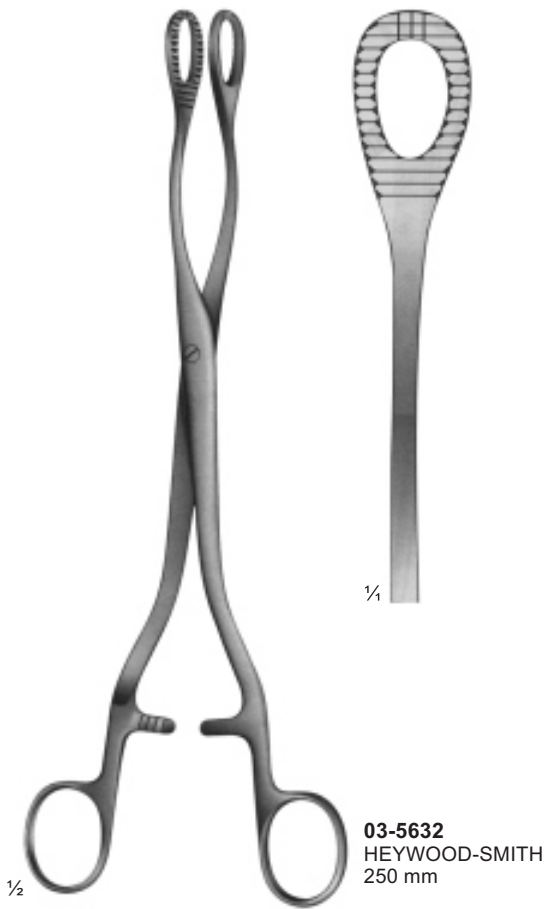

Gall Duct Probes

∅ 3.5 mm



03-5639
HAJEK
Irrigating cannula,
silver
165 mm

∅ 5 mm



03-5640
MOYNIHAN
Gall stone probe
and scoop of tin,
malleable.
365 mm

∅ 5 mm



03-5641
MAYO
Gall duct probes,
malleable
330 mm

∅ 3.5 mm

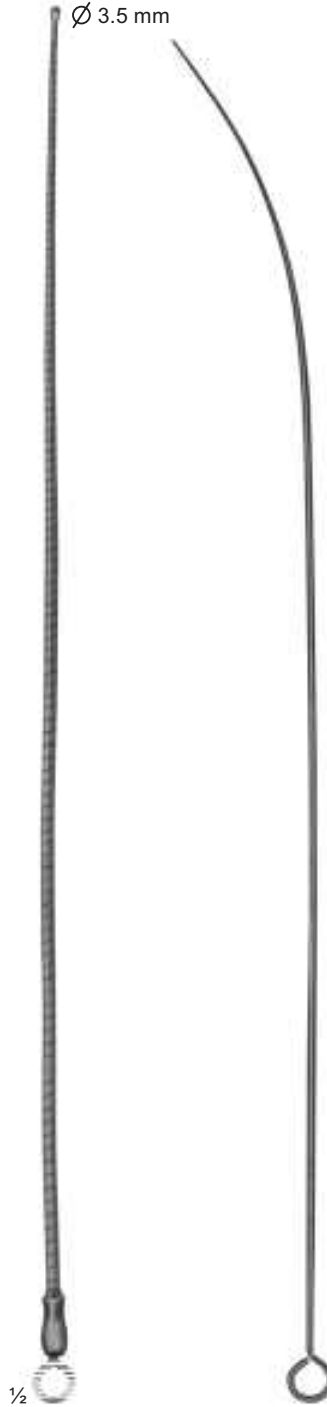

03-5642
OCHSNER
Gall duct probes, flexible
400 mm

∅ 3.8 mm



03-5643



03-5644
∅ 4.3mm



03-5645
∅ 6.8mm

03-5643 - 03-5645
DESJARDINS
Gall duct probes,
flexible
285 mm

Gall Duct Dilators & Gall Stone Scoops

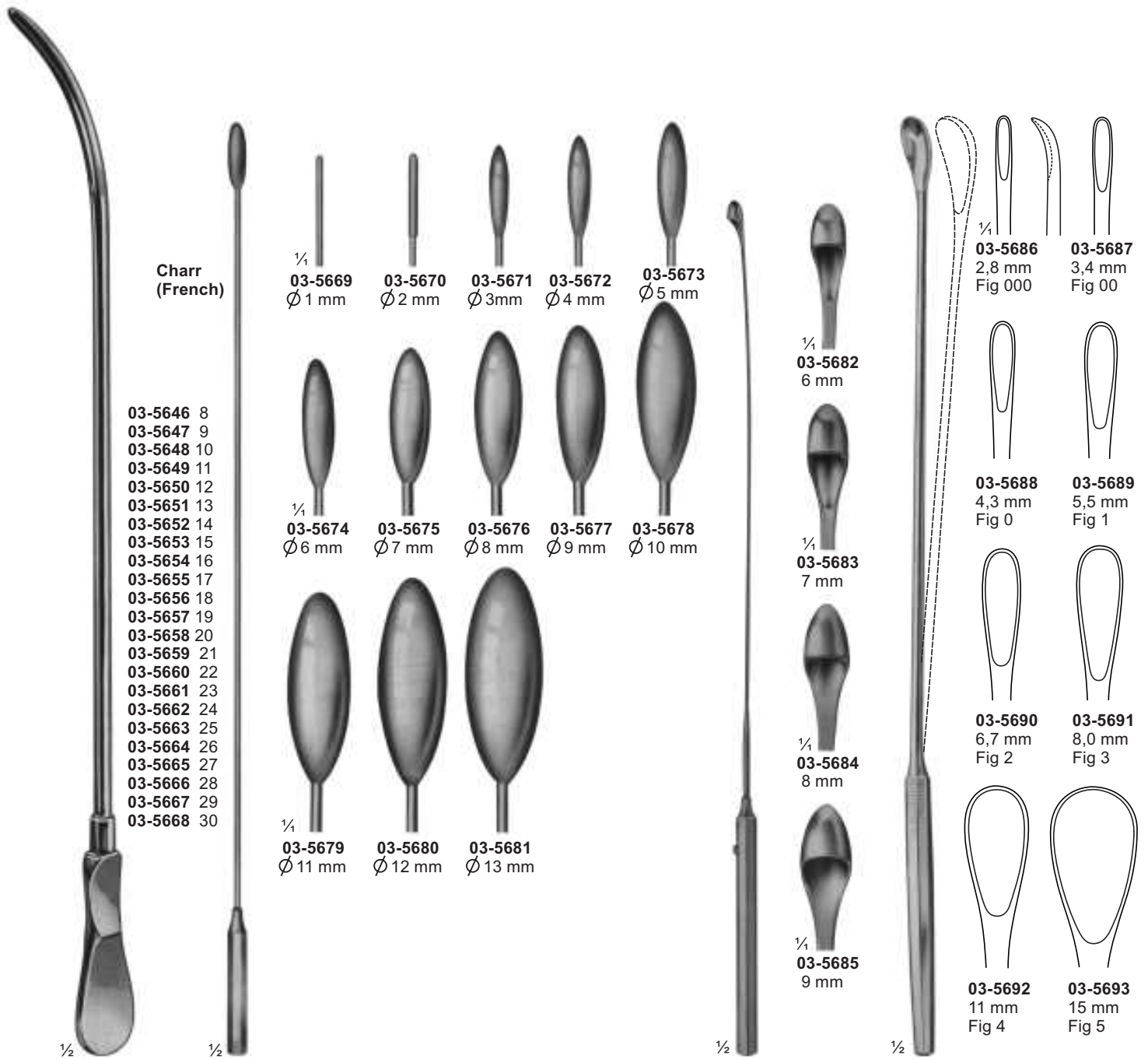

**Charr
(French)**

- 03-5646 8
- 03-5647 9
- 03-5648 10
- 03-5649 11
- 03-5650 12
- 03-5651 13
- 03-5652 14
- 03-5653 15
- 03-5654 16
- 03-5655 17
- 03-5656 18
- 03-5657 19
- 03-5658 20
- 03-5659 21
- 03-5660 22
- 03-5661 23
- 03-5662 24
- 03-5663 25
- 03-5664 26
- 03-5665 27
- 03-5666 28
- 03-5667 29
- 03-5668 30

- 1/4 03-5669 Ø 1 mm
- 03-5670 Ø 2 mm
- 03-5671 Ø 3 mm
- 03-5672 Ø 4 mm
- 03-5673 Ø 5 mm
- 1/4 03-5674 Ø 6 mm
- 03-5675 Ø 7 mm
- 03-5676 Ø 8 mm
- 03-5677 Ø 9 mm
- 03-5678 Ø 10 mm
- 1/4 03-5679 Ø 11 mm
- 03-5680 Ø 12 mm
- 03-5681 Ø 13 mm

- 1/4 03-5682 6 mm
- 1/4 03-5683 7 mm
- 1/4 03-5684 8 mm
- 1/4 03-5685 9 mm

- 1/4 03-5686 2,8 mm Fig 000
- 03-5687 3,4 mm Fig 00
- 03-5688 4,3 mm Fig 0
- 03-5689 5,5 mm Fig 1
- 03-5690 6,7 mm Fig 2
- 03-5691 8,0 mm Fig 3
- 03-5692 11 mm Fig 4
- 03-5693 15 mm Fig 5

03-5646 - 03-5668
DITTEL
Metal bougies and dilating sounds, stiff 345 mm

03-5669 - 03-5681
BAKES
Common bile duct dilators, malleable
03-5669-03-5673 315mm
03-5674-03-5681 320mm
Set of 9 pieces (03-5671-03-5679) in canvas roll

03-5682 - 03-5685
DESJARDINS
Probes and catch with flexible shaft 300 mm

03-5686 - 03-5693
LUER-KOERTE
modif with malleable shaft 310 mm

Gall Stone Forceps

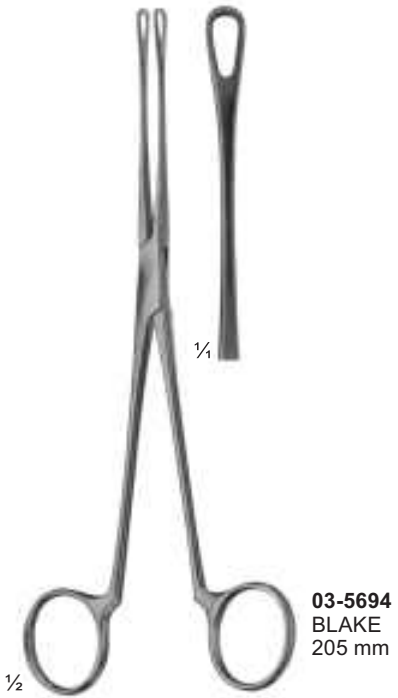

03-5694
BLAKE
205 mm



03-5695
BLAKE
205 mm

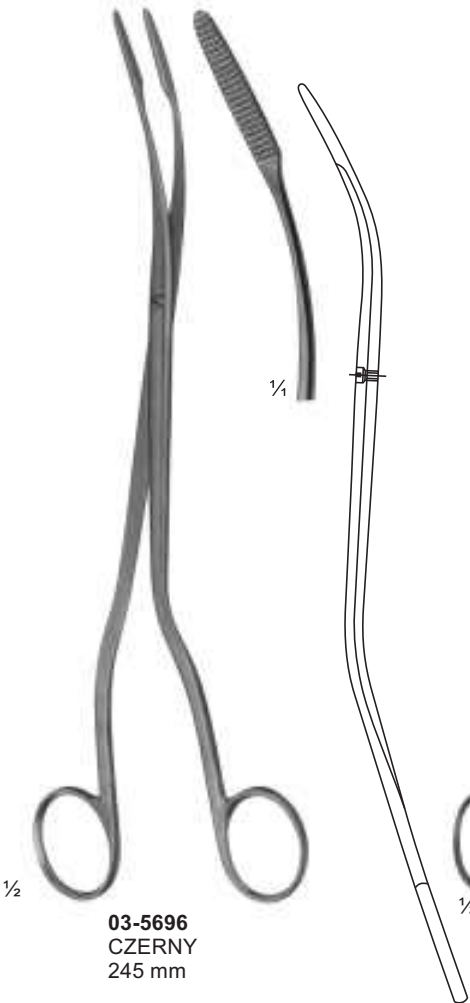

03-5696
CZERNY
245 mm

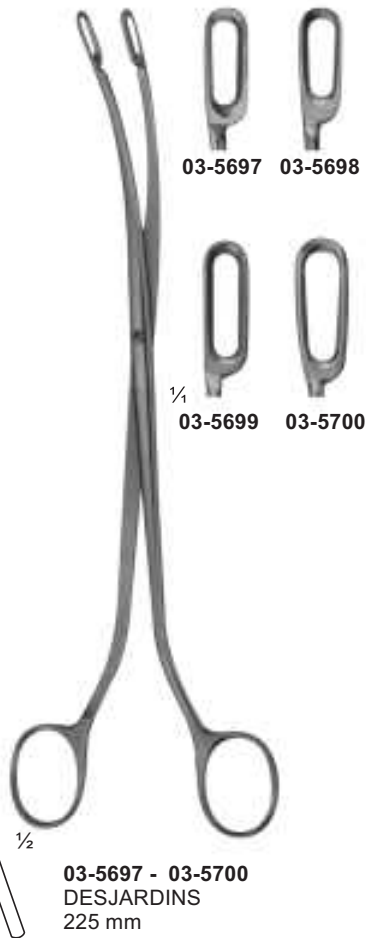

03-5697 - 03-5700
DESJARDINS
225 mm

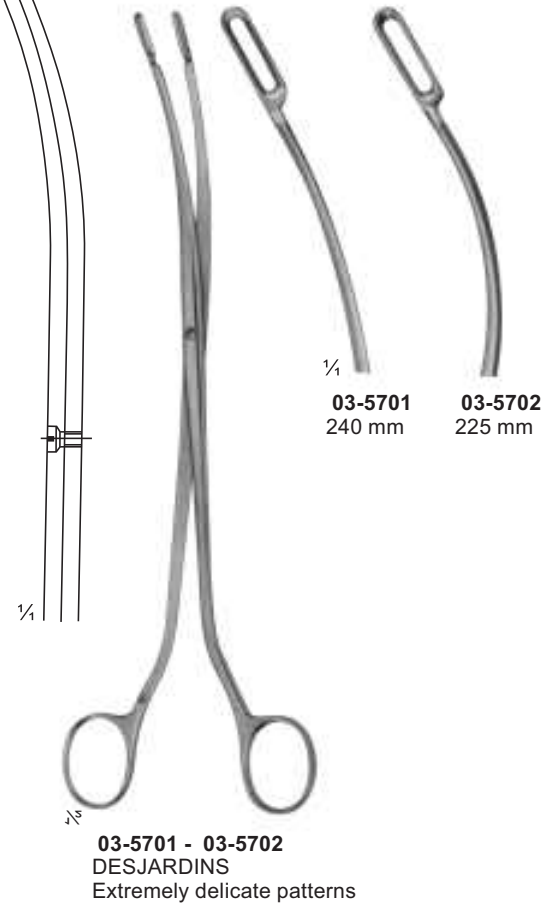

03-5701 - 03-5702
DESJARDINS
Extremely delicate patterns

Kidney Clamps

Atraumata

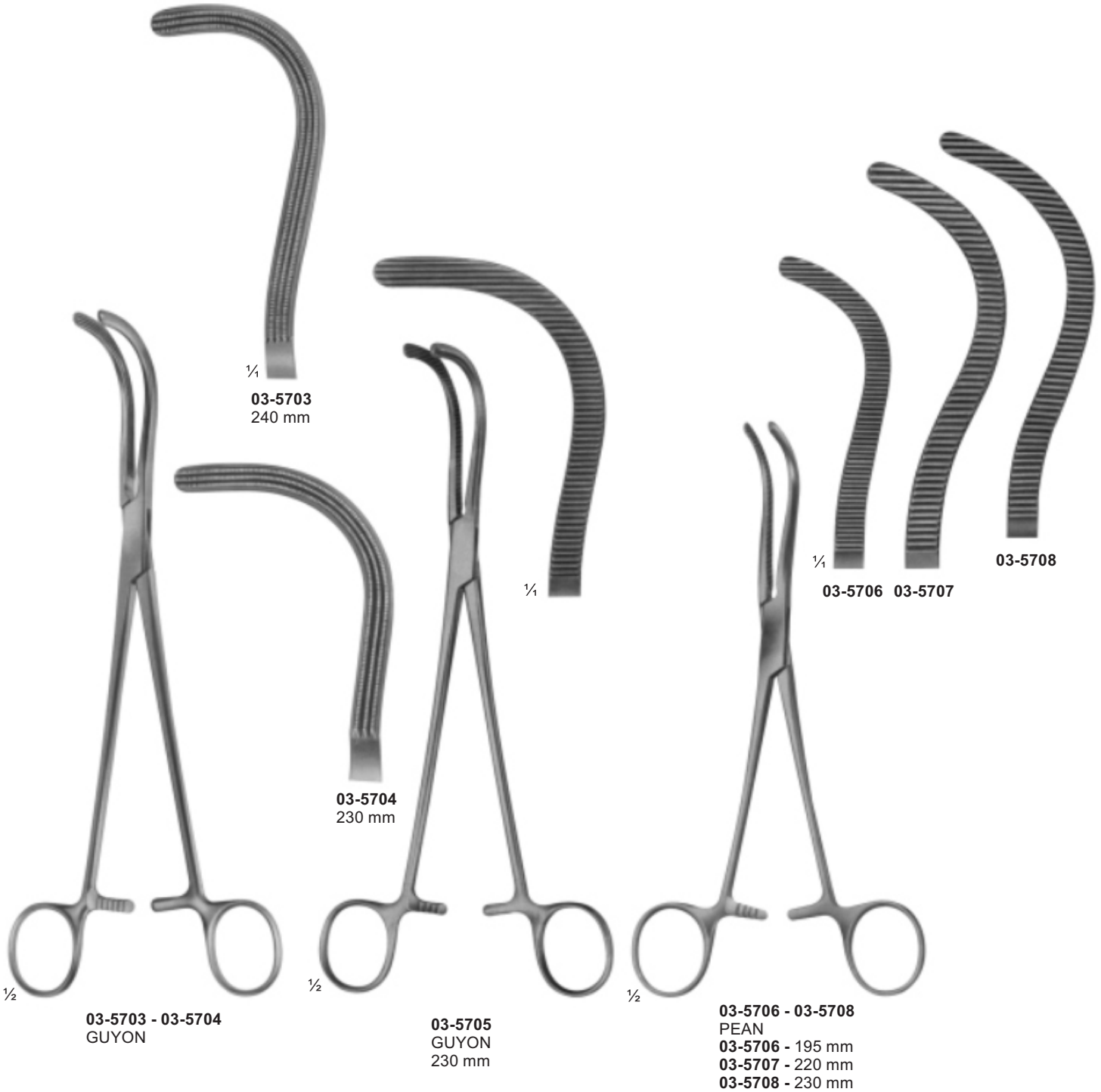

Kidney and Pedicle Clamps

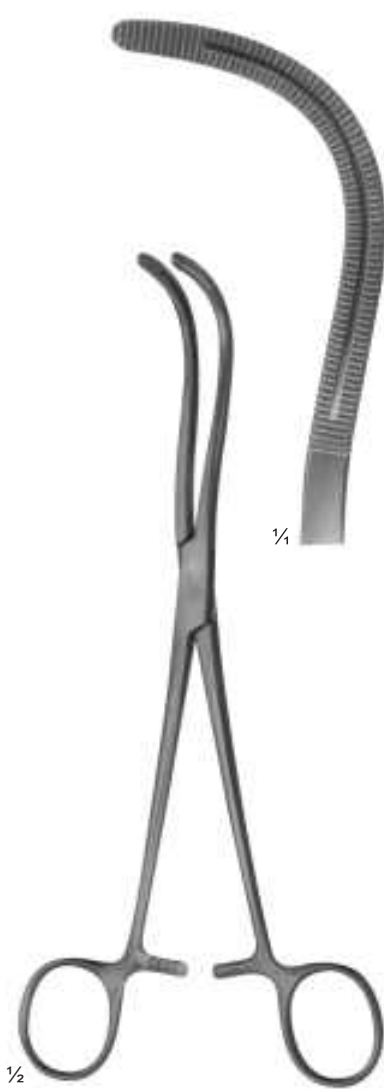

03-5709
STILLE
220 mm

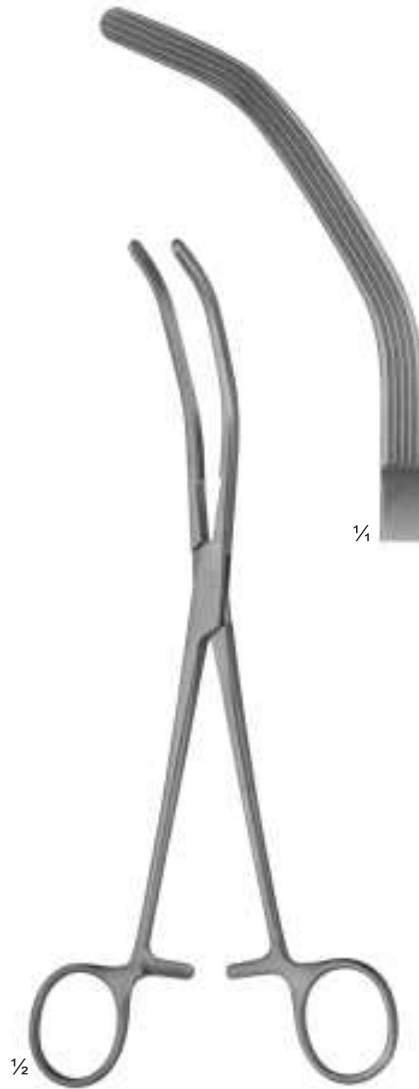

03-5710
HERRICK
225 mm



03-5711
WERTHEIM
225 mm

Kidney Elevating Forceps



1/2

03-5712
COLLIN
285 mm



1/2

03-5713
DARTIGUES
255 mm

Kidney Stone Forceps



03-5714



03-5715



03-5716



$\frac{1}{4}$
03-5717



03-5718



$\frac{1}{4}$

03-5719



$\frac{1}{2}$

03-5718 - 03-5719
RANDALL
190 mm



$\frac{1}{2}$

03-5714 - 03-5717
RANDALL
225 mm

Bladder Retractors

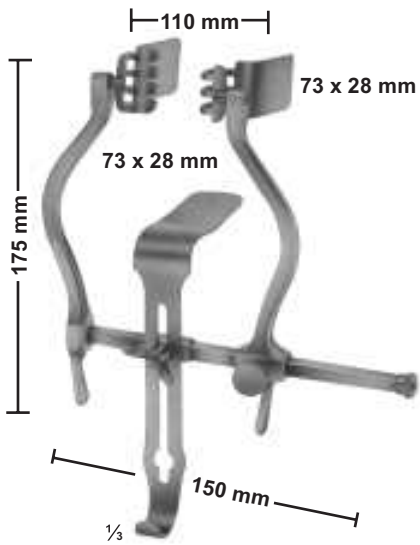

03-5720
JUDD-MASSON
 Bladder-and suprapubic retractor

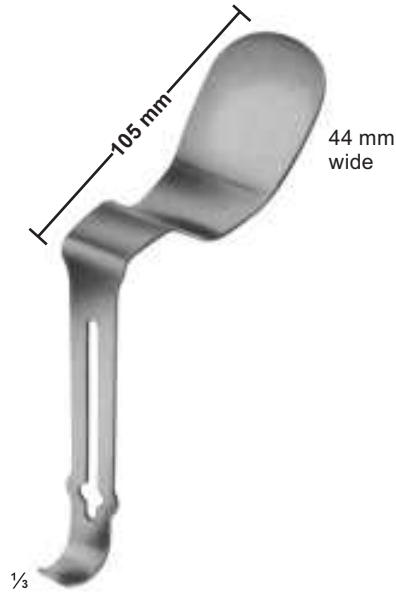

03-5721
MILLIN
 Center blade for (**05-6993**)
 retro pubic prostatectomy



03-5722
MILLIN
 Bladder retractor
03-5722 Spreader only
03-5723 Blades 57x25mm
03-5724 Blades 82x25mm
03-5725 Center blade 105x45mm



03-5726
LEGUEU
 Bladder retractor
 Center blade
 80 x 31 mm



03-5727
LEGUEU
 Bladder spatula
 260 mm

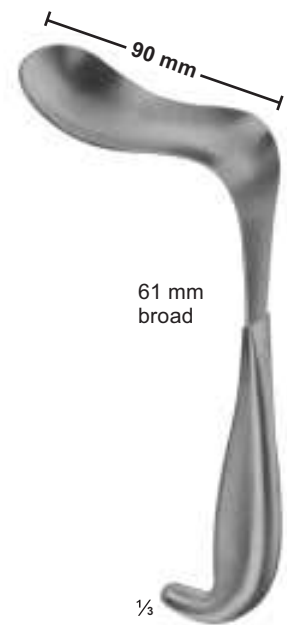

03-5728
KOCHER
 Bladder spatula
 235 mm



03-5729
MATHIEU
Foreign body forceps
Length of shaft
190 mm



03-5730
MILLIN
Lobe grasping
forceps
235 mm

Atraumata

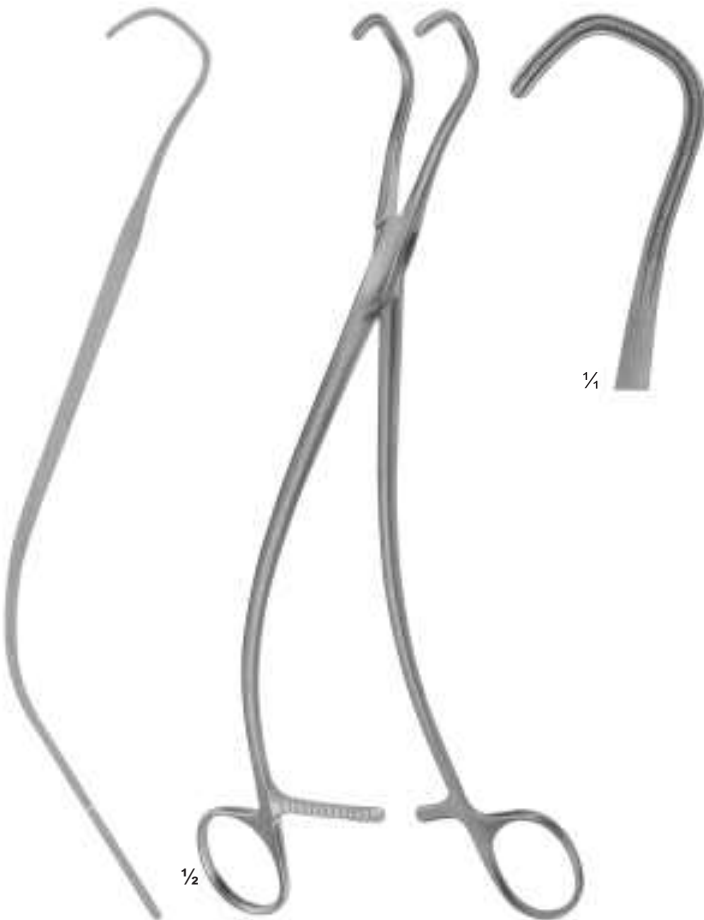

03-5731
Ureter forceps
240 mm

Atraumata

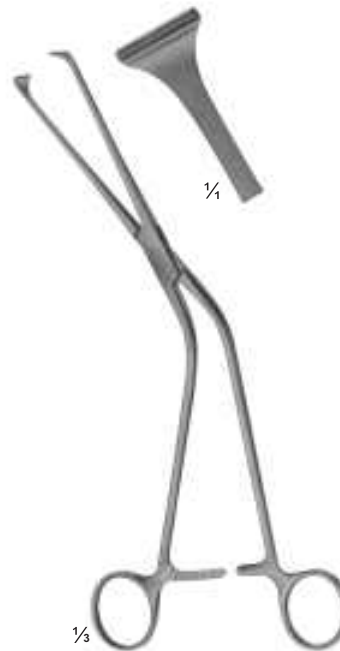

03-5732
MILLIN
Lobe grasping
forceps
245 mm



03-5733
MILLIN
Bladder neck spreader
285 mm



03-5734
GUYON
Catheter guide
(introducer)
365 mm

**Charr.
(French)**

- 03-5735 6
- 03-5736 7
- 03-5737 8
- 03-5738 9
- 03-5739 10
- 03-5740 11
- 03-5741 12
- 03-5742 13
- 03-5743 14
- 03-5744 15
- 03-5745 16
- 03-5746 18
- 03-5747 20

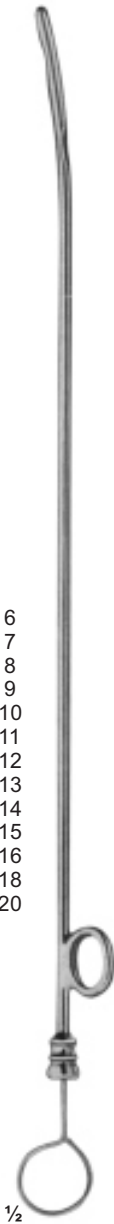

03-5735 - 03-5747
Female catheters,
metal
160 mm

**Charr.
(French)**

- 03-5748 8
- 03-5749 9
- 03-5750 10
- 03-5751 11
- 03-5752 12
- 03-5753 13
- 03-5754 14
- 03-5755 15
- 03-5756 16
- 03-5757 17
- 03-5758 18
- 03-5759 19
- 03-5760 20
- 03-5761 21
- 03-5762 22
- 03-5763 23
- 03-5764 24
- 03-5765 25
- 03-5766 26
- 03-5767 27
- 03-5768 28
- 03-5769 29
- 03-5770 30

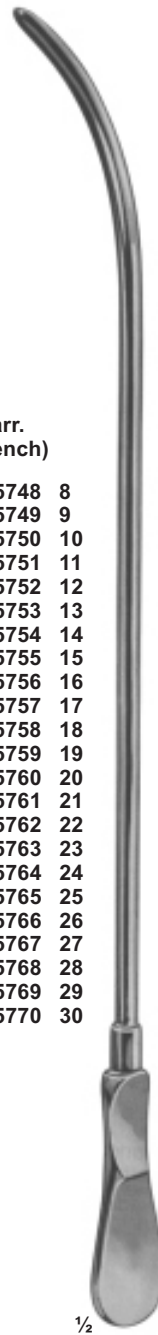

03-5748 - 03-5770
DITTEL
Urethral bougies
and dilating sounds
345 mm

- 03-5771 Ben. 24/Charr. 12
- 03-5772 Ben. 25
- 03-5773 Ben. 26/Charr. 13
- 03-5774 Ben. 27
- 03-5775 Ben. 28/Charr. 14
- 03-5776 Ben. 29
- 03-5777 Ben. 30/Charr. 15
- 03-5778 Ben. 31
- 03-5779 Ben. 32/Charr. 16
- 03-5780 Ben. 33
- 03-5781 Ben. 34/Charr. 17
- 03-5782 Ben. 35
- 03-5783 Ben. 36/Charr. 18
- 03-5784 Ben. 37
- 03-5785 Ben. 38/Charr. 19
- 03-5786 Ben. 39
- 03-5787 Ben. 40/Charr. 20
- 03-5788 Ben. 41
- 03-5789 Ben. 42/Charr. 21
- 03-5790 Ben. 43
- 03-5791 Ben. 44/Charr. 22
- 03-5792 Ben. 45
- 03-5793 Ben. 46/Charr. 23
- 03-5794 Ben. 47
- 03-5795 Ben. 48/Charr. 24
- 03-5796 Ben. 49
- 03-5797 Ben. 50/Charr. 25
- 03-5798 Ben. 51
- 03-5799 Ben. 52/Charr. 26
- 03-5800 Ben. 53
- 03-5801 Ben. 54/Charr. 27
- 03-5802 Ben. 55
- 03-5803 Ben. 56/Charr. 28
- 03-5804 Ben. 57
- 03-5805 Ben. 58/Charr. 29
- 03-5806 Ben. 59
- 03-5807 Ben. 60/Charr. 30

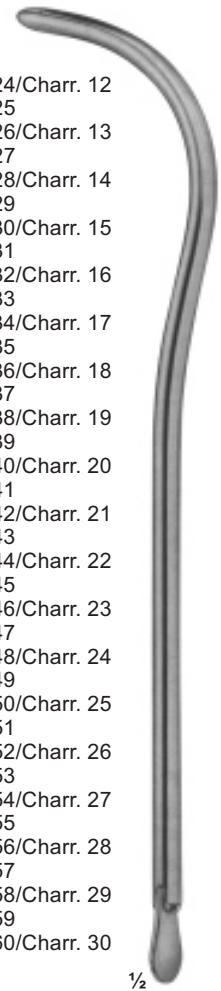

03-5771 - 03-5807
GUYON
Urethral bougies
and dilating sounds,
without filiform guides,
with thread in tip
255 mm

Genito-Urinary Instruments & Circumcision Clamps



03-5808
GUYON
Set of urethral bougies and dilating sounds, in metal case, with lift out rack and bottom rack, containing 21 urethral and dilating sounds, metal.



03-5809 - 03-5811
WINKELMANN
03-5809 ∅ 12mm
03-5810 ∅ 16mm
03-5811 ∅ 20mm

Circumcision Clamps

Assisted by two haemostats or ligatures the foreskin is pushed over the bellshaped protection - rod and the glans is placed into it. By now, the wing - nut is tightened as close as possible, so the foreskin in annular compressed. The foreskin is cut of with a scalpel, right nest to the compression ring. The circumcision clamp remains a few minutes to avoid bleeding. In case that any large vein, specially the frenular artery, is cut through, a ligature must be set. The advantage of the method described is the cosmeticy favourable scar which is left after rejection of the small necrotized portion.

Trocars



Luer Lock

03-5812
KLIMA ROSEGGER
35 X 1,8 mm
Sternal puncture needle

03-5813
Universal trocar
with 4 tips

ϕ 6,0 mm
 ϕ 4,5 mm
 ϕ 3,3 mm
 ϕ 1,9 mm

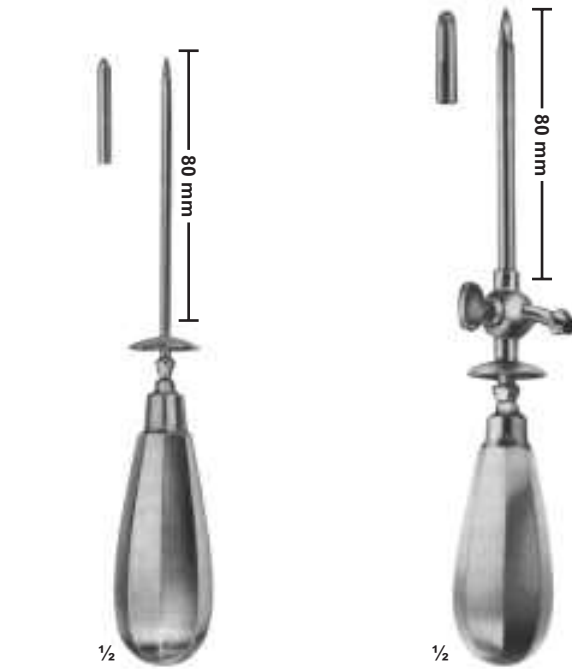

03-5814 - 03-5818
NELSON

	Inside diam	Outside diam
03-5814	2,2 mm	3,0 mm
03-5815	3,0 mm	4,0 mm
03-5816	4,0 mm	5,0 mm
03-5817	5,0 mm	6,0 mm
03-5818	5,5 mm	6,5 mm

for hydrocele and abdominal puncture

03-5819 - 03-5822

	Inside diam	Outside diam
03-5819	2,2 mm	3,0 mm
03-5820	3,0 mm	4,0 mm
03-5821	4,0 mm	5,0 mm
03-5822	5,0 mm	6,0 mm

for abdominal puncture, with stop-cock and lateral drain

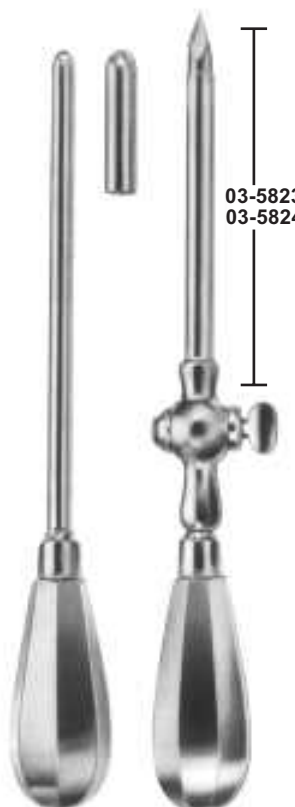

03-5823 100 mm
03-5824 110 mm

03-5823 - 03-5824
BUELAU

	Inside diam	Outside diam
03-5823	6,5 mm	8,0 mm
03-5824	9,0 mm	10,0 mm

Empyema trocar

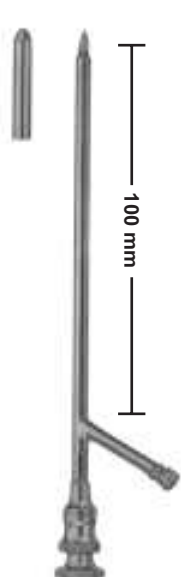

03-5825 - 03-5828
OCHSNER

	Inside diam.	Outside diam
03-5825	3,0 mm	4,0 mm
03-5826	3,6 mm	4,6 mm
03-5827	4,3 mm	5,3 mm
03-5828	5,0 mm	6,0 mm

Gall bladder trocars



Record Cone 1

03-5829
PIERCE
Antrum trocar
 ϕ 4,0 mm



Luer Lock Cone

03-5830
COAKLEY
Antrum trocar
 ϕ 3,0 mm

Vaginal specula

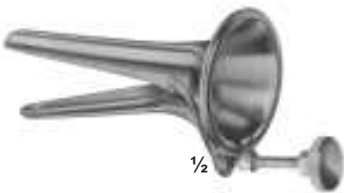

04-6001
COLLIN
for children
53 x 10 mm

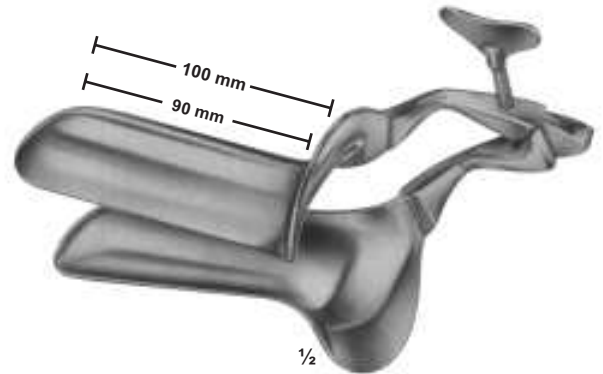

04-6002 - 04-6005
COLLIN

04-6002	100/90mm	28 mm
04-6003	100/90mm	32 mm
04-6004	105/95mm	35 mm
04-6005	115/105mm	40 mm

 Total length/working length width



04-6006
COLLIN
for virgins
95/85 x 18 mm

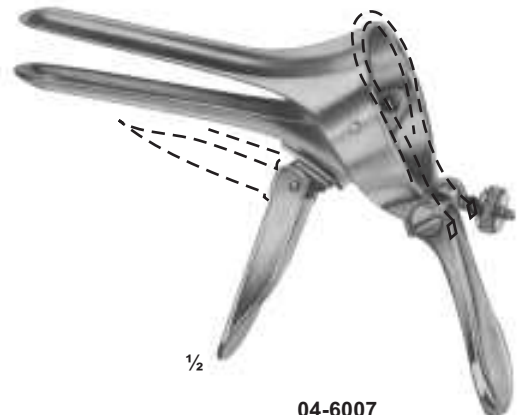

04-6007
CUSCO
for virgins
75 x 17 mm

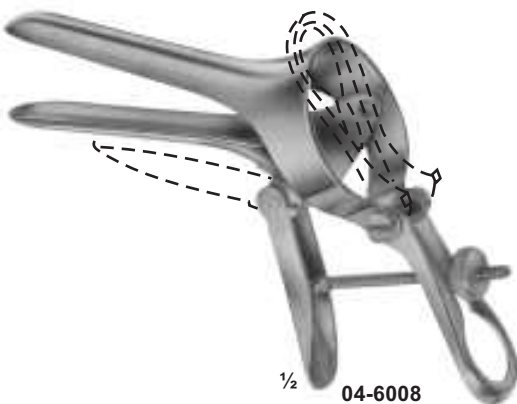

04-6008
CUSCO
for virgins
75 x 17 mm

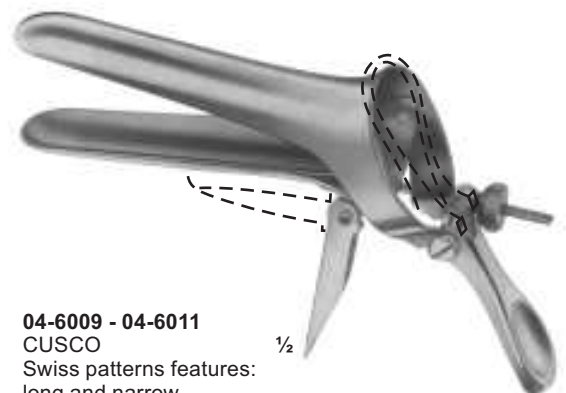

04-6009 - 04-6011
CUSCO
Swiss patterns features:
long and narrow
04-6009 92X23-25 mm
04-6010 100x25-27 mm
04-6011 110x27-30 mm

Vaginal Specula



04-6012 - 04-6015
CUSCO
STANDARD
04-6012 80X24 mm
04-6013 80X32 mm
04-6014 90X36 mm
04-6015 110X37 mm

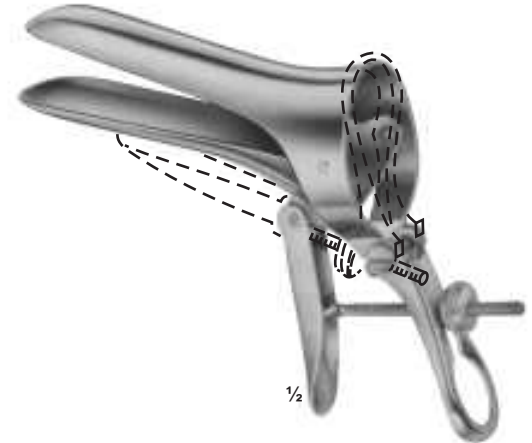

04-6016 - 04-6019
CUSCO
04-6016 80X24 mm
04-6017 80X32 mm
04-6018 90X36 mm
04-6019 110X37 mm

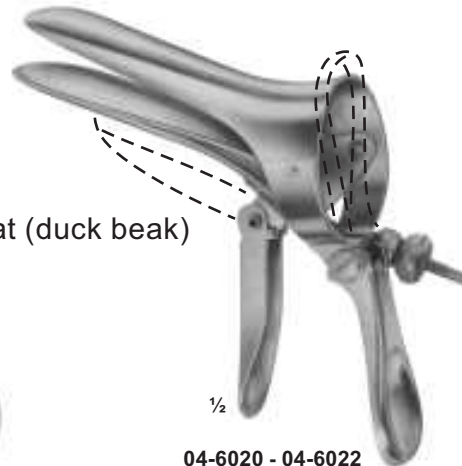

Flat (duck beak)

04-6020 - 04-6022
CUSCO
04-6020 80X32 mm
04-6021 90X37 mm
04-6022 115X37 mm



04-6023 - 04-6024
SEYFFERT
04-6023 100X17 mm
04-6024 110X33 mm
230 mm



With double ratchet, closing and opening of ratchet by pressure of thumb

04-6025
SEMM
for children and virgins
180 mm
90X14-18mm

Vaginal Specula, Sets, Upper & Lower Blade



04-6026 - 04-6028
GRAVE
04-6026 75X20 mm
04-6027 95X30 mm
04-6028 105X33 mm

1/2



04-6029 - 04-6030
PEDERSON
04-6029 100X22 mm
04-6030 120X25 mm

1/2



04-6031 - 04-6032
BRIESKY
04-6031 72X25 mm / 77X30 mm 140mm
04-6032 75X30 mm / 92X38 mm 170mm

1/2



04-6033 - 04-6035
SIMS
04-6033 70X26 mm / 75 X30 mm
125 mm
04-6034 75X30 mm / 80X35 mm
150 mm
04-6035 80X36 mm / 90X40mm
175mm

1/2



04-6036 - 04-6038
SEIDL
04-6036 80X8 mm
04-6037 80X10 mm
04-6038 90X14 mm
For children and infants
170 mm

1/2



04-6039
KRISTELLER
70X15 mm, (170 mm)
For children

1/2



1/2

04-6040 - 04-6042
KRISTELLER
04-6040 70X27 mm
04-6041 75X30 mm
04-6042 90X36 mm
175 mm

Vaginal Specula-Sets, upper and lower blade

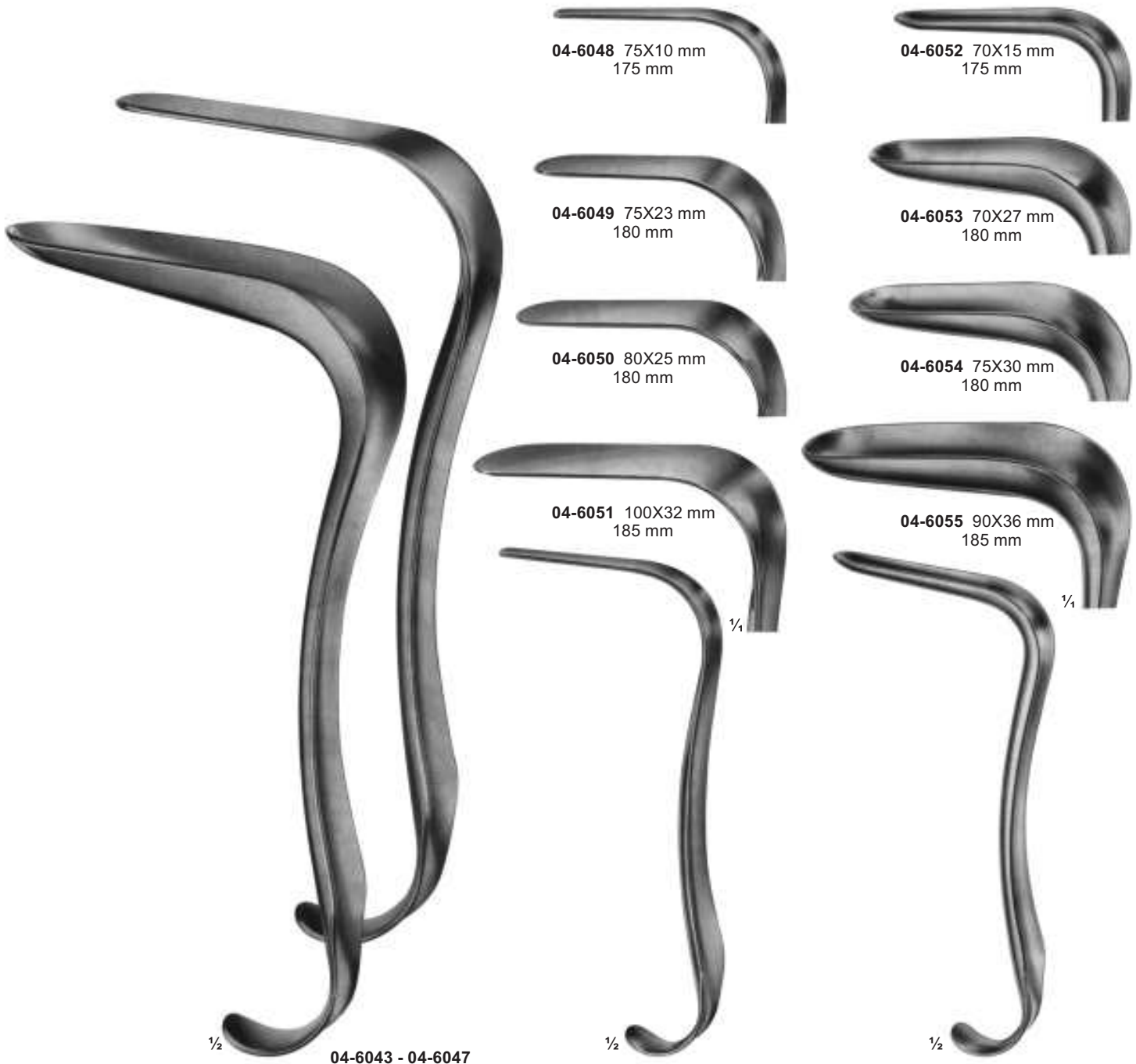

1/2
04-6043 - 04-6047
 KRISTELLER
04-6043 110X18 mm
04-6044 110X20 mm
04-6045 110X27 mm
04-6046 110X30 mm
04-6047 110X36 mm
 220 mm

1/2
04-6048 - 04-6051
 KRISTELLER
 Upper blades

1/2
04-6052 - 04-6055
 KRISTELLER
 Lower blades

Vaginal Specula-upper and lower blades

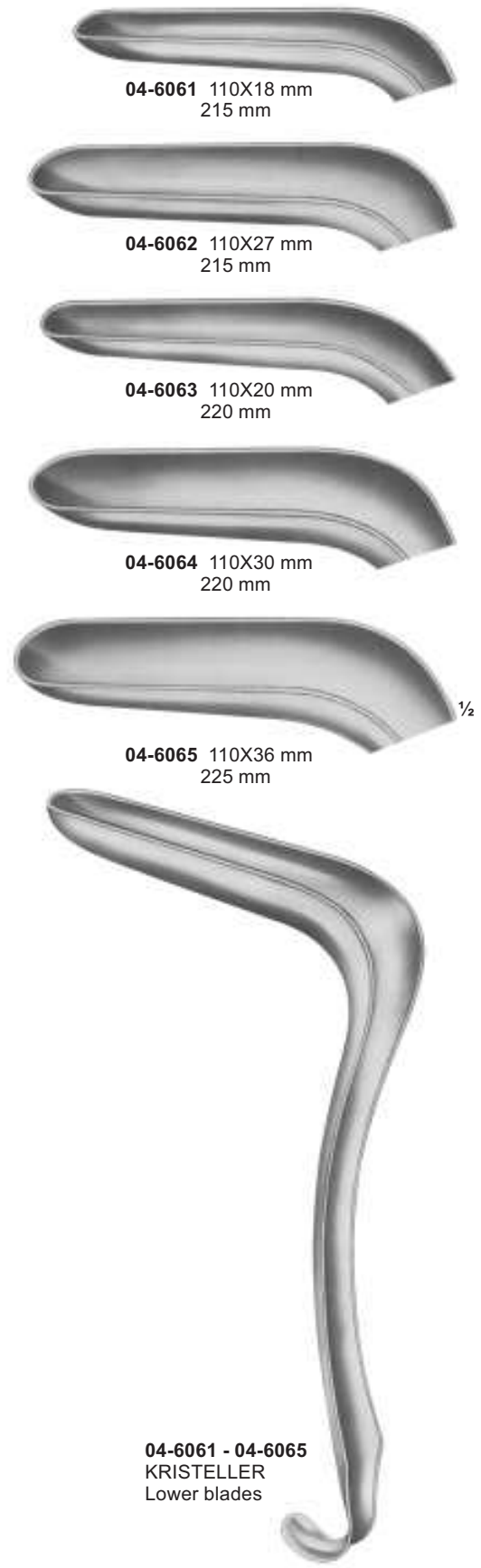
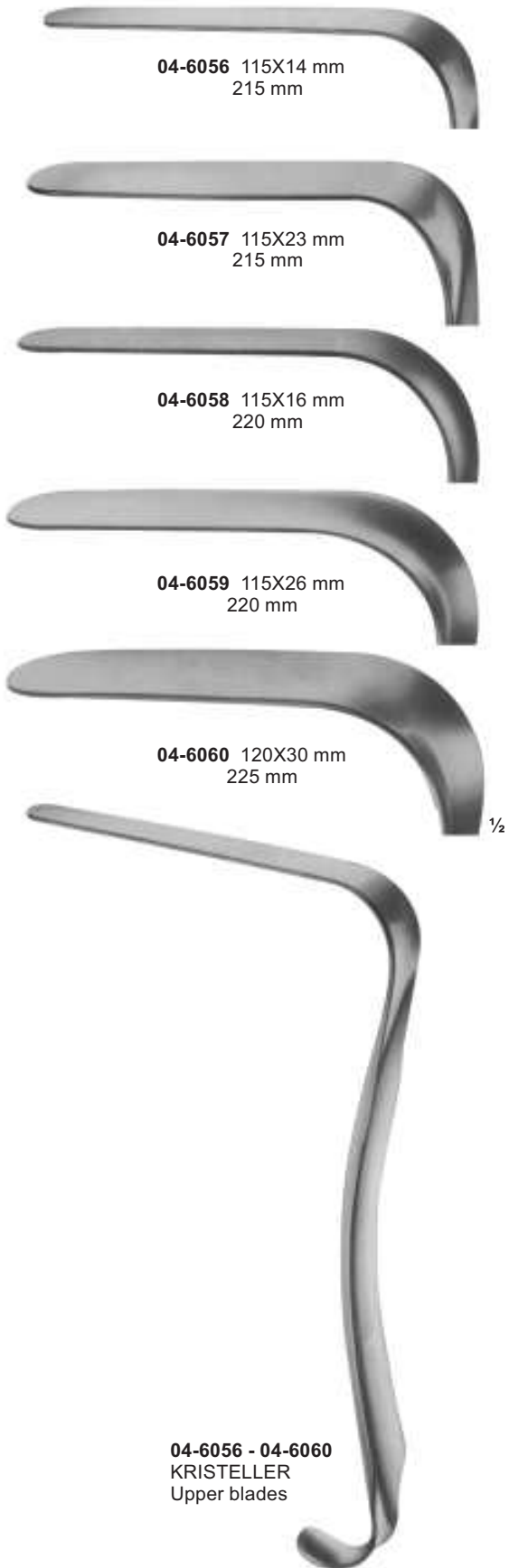

Vaginal Specula



04-6066 - 04-6068
KRISTELLER
205 mm



04-6069 - 04-6071
JACKSON
175 mm

Vaginal Specula-for children & virgins Vario Retractor

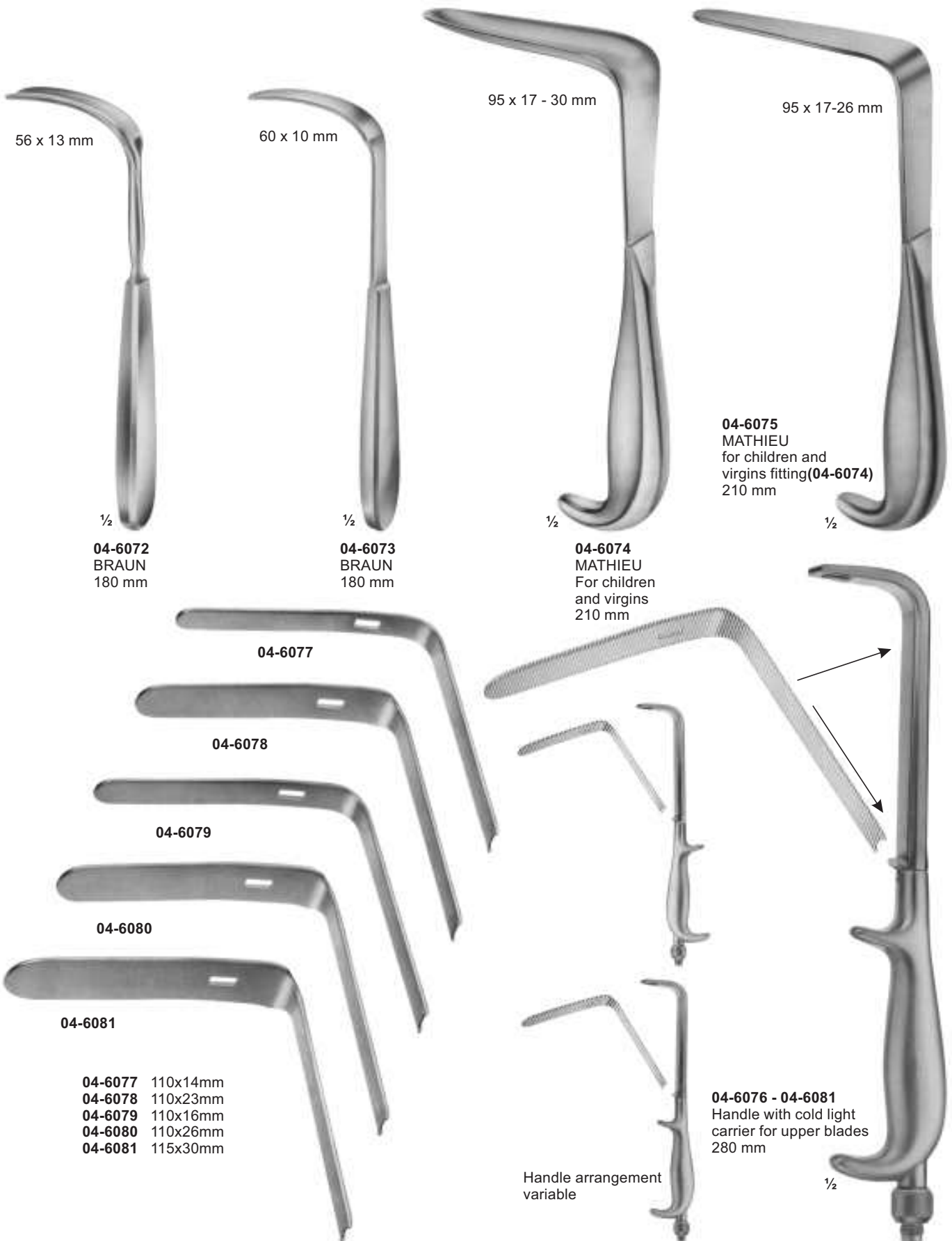

56 x 13 mm

1/2

04-6072
BRAUN
180 mm

60 x 10 mm

1/2

04-6073
BRAUN
180 mm

95 x 17 - 30 mm

1/2

04-6074
MATHIEU
For children
and virgins
210 mm

95 x 17-26 mm

1/2

04-6075
MATHIEU
for children and
virgins fitting(**04-6074**)
210 mm

04-6077

04-6078

04-6079

04-6080

04-6081

04-6077 110x14mm
04-6078 110x23mm
04-6079 110x16mm
04-6080 110x26mm
04-6081 115x30mm

Handle arrangement
variable

04-6076 - 04-6081
Handle with cold light
carrier for upper blades
280 mm

1/2

Vaginal Specula-for children and virgins



04-6082 - 04-6084
DOYEN
235 mm

Length of blades	Width of blades			DOYEN
	35 mm	45 mm	60 mm	
60 mm	04-6085	04-6088	04-6091	04-6085 - 04-6094 240mm
90 mm	04-6086	04-6089	04-6092	
120 mm	04-6087	04-6090	04-6093	
160 mm		04-6090A	04-6094	

Vaginal Specula / Retractors



04-6095 - 04-6099
BREISKY
WIENER MODELL/
VIENNA PATTERN
04-6095 100 X 20 mm
04-6096 100 X 25 mm
04-6097 100 X 30 mm
04-6098 100 X 35 mm
04-6099 100 X 40 mm
300 mm

04-6100 - 04-6104
BREISKY
WIENER MODELL/
VIENNA PATTERN
04-6100 130 X 20 mm
04-6101 130 X 25 mm
04-6102 130 X 30 mm
04-6103 130 X 35 mm
04-6104 130 X 40 mm
320 mm

04-6107
removable strainer only

04-6105 - 04-6106
WEISSBARTH
04-6105 80 X 28 mm
04-6106 85 X 42 mm
210 mm

04-6108
DOYEN
lateral speculum
80 x 30 mm
250 mm

Vaginal & Wound Retractor / Vaginal Specula



04-6109 - 04-6110
SIMON
115 X 22 mm
275 mm



04-6112 - 04-6113
AUVARD
04-6112 75 X 42-40 mm
04-6113 105 X 43-40 mm
1,470 kg = 3 lbs
with detachable weight
230 mm

04-6111
AUVARD
65 X 38 mm - 28 mm
1,530 kg = 3 lbs
with fixed weight
230 mm



04-6114 - 04-6117
MARTIN
with hook shaped
handle for hanging
in weights
270 mm

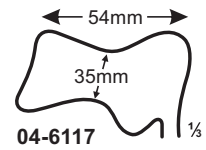
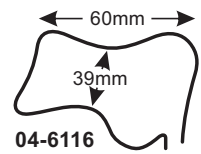
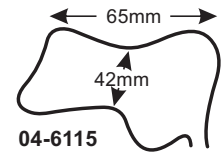
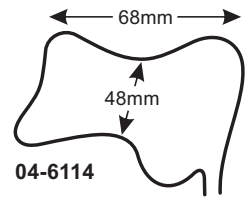

04-6110
115 X 26 mm
275 mm

Vaginal Speculas

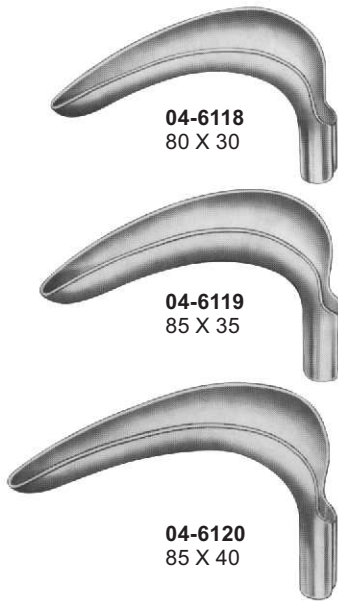

04-6118
80 X 30

04-6119
85 X 35

04-6120
85 X 40

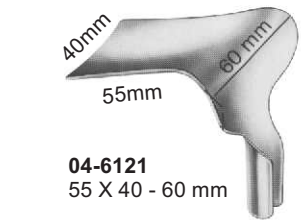

04-6121
55 X 40 - 60 mm



04-6122
70 X 45 - 70 mm



04-6123

04-6124

The mentioned blades (**04-6118 - 04-6122** and **04-6125 - 04-6132**) can be exchanged. They fit handle (**04-6123**), as well as handles (**04-6133** and **04-6134**).

04-6118 - 04-6124
SCHERBACK
Set consisting of:
handle **04-6123**
weight **04-6124**
4 blades **04-6118 - 04-6121**



04-6125
80 X 30 mm

04-6129
65 X 30 mm

04-6126
85 X 33 mm

04-6130
75 X 35 mm

04-6127
100 X 38 mm

04-6131
85 X 35 mm

04-6128
110 X 42 mm

04-6132
95 X 35 mm

04-6133
BOZEMANN
Set consisting of:
2 handle (**04-6133 - 04-6134**)
8 blades (**04-6125 - 04-6132**)

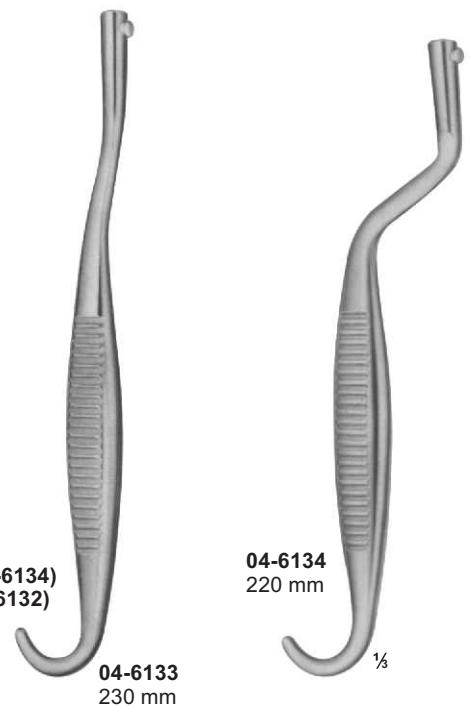

04-6133
230 mm

04-6134
220 mm

Vaginal Retractors



1/2
04-6135
JOLL (FRIEDMAN)
155 mm



1/2
04-6136
RICHTER
170 mm



1/2
04-6137
GELPI
135 mm



1/2
04-6138
GELPI
175 mm

Uterine Dilators



1/2

04-6139 - 04-6181
HEGAR
with very conical point
185 mm

04-6139	1	mm	04-6161	23	mm
04-6140	2	mm	04-6162	24	mm
04-6141	3	mm	04-6163	25	mm
04-6142	4	mm	04-6164	26	mm
04-6143	5	mm	04-6165	1	1/2mm
04-6144	6	mm	04-6166	2	1/2mm
04-6145	7	mm	04-6167	3	1/2mm
04-6146	8	mm	04-6168	4	1/2mm
04-6147	9	mm	04-6169	5	1/2mm
04-6148	10	mm	04-6170	6	1/2mm
04-6149	11	mm	04-6171	7	1/2mm
04-6150	12	mm	04-6172	8	1/2mm
04-6151	13	mm	04-6173	9	1/2mm
04-6152	14	mm	04-6174	10	1/2mm
04-6153	15	mm	04-6175	11	1/2mm
04-6154	16	mm	04-6176	12	1/2mm
04-6155	17	mm	04-6177	13	1/2mm
04-6156	18	mm	04-6178	14	1/2mm
04-6157	19	mm	04-6179	15	1/2mm
04-6158	20	mm	04-6180	16	1/2mm
04-6159	21	mm	04-6181	17	1/2mm
04-6160	22	mm			



1/2

04-6182 - 04-6190
HEGAR
205 mm

04-6182	1+2	mm
04-6183	3+4	mm
04-6184	5+6	mm
04-6185	7+8	mm
04-6186	9+10	mm
04-6187	11+12	mm
04-6188	13+14	mm
04-6189	15+16	mm
04-6190	17+18	mm

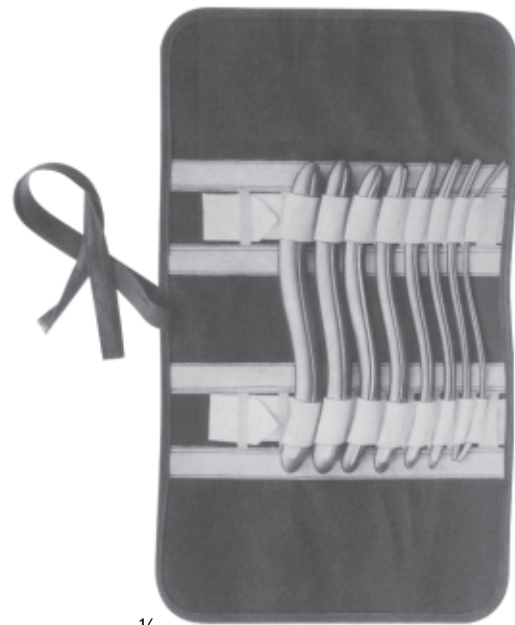

1/4

04-6191
HEGAR
Uterine dilator set, in canvas roll
with 8 dilators.

Uterine Dilators - Complete Sets



04-6192
HEGAR
Dilator set consisting of:
14 Dilators,
(04-6193) 1 Rack for dilators (4 - 12 mm)
(04-6194) 1 Rack for Dilators (13 - 17 mm)
(04-6195) 1 Metal case only,
with hinged lid, stainless 200 X 100 X 35 mm

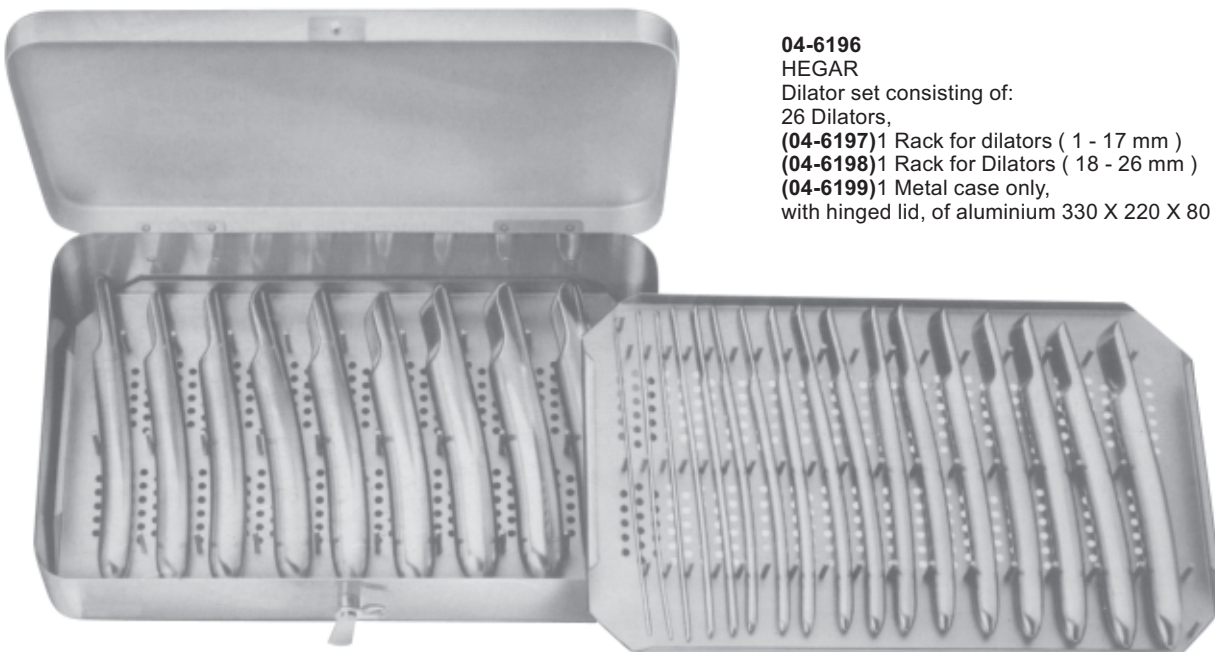

04-6196
HEGAR
Dilator set consisting of:
26 Dilators,
(04-6197) 1 Rack for dilators (1 - 17 mm)
(04-6198) 1 Rack for Dilators (18 - 26 mm)
(04-6199) 1 Metal case only,
with hinged lid, of aluminium 330 X 220 X 80 mm

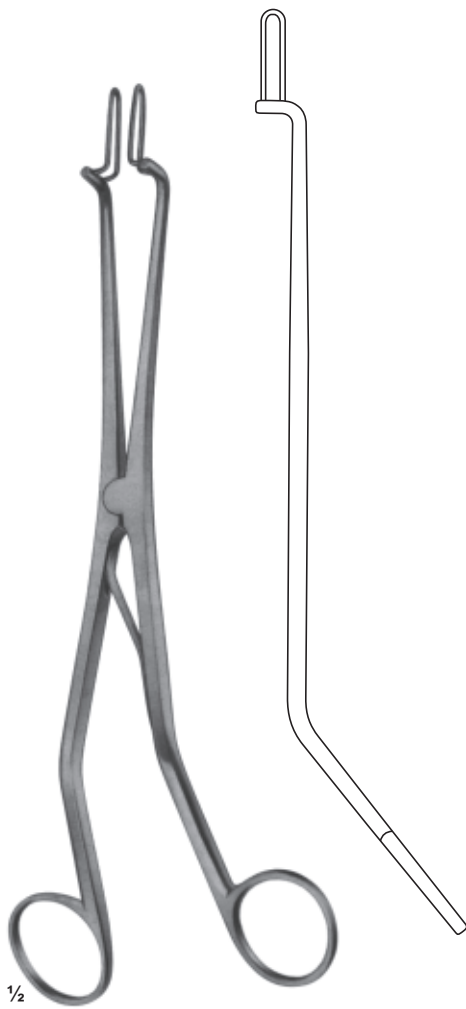

04-6200
KOGAN
Endospecula for cervix
and urethra, without ratchet
240 mm



04-6201
KOGAN
Endospecula for cervix
and urethra, with
scale-ratchet and fixing screws
240 mm

Uterine Probes

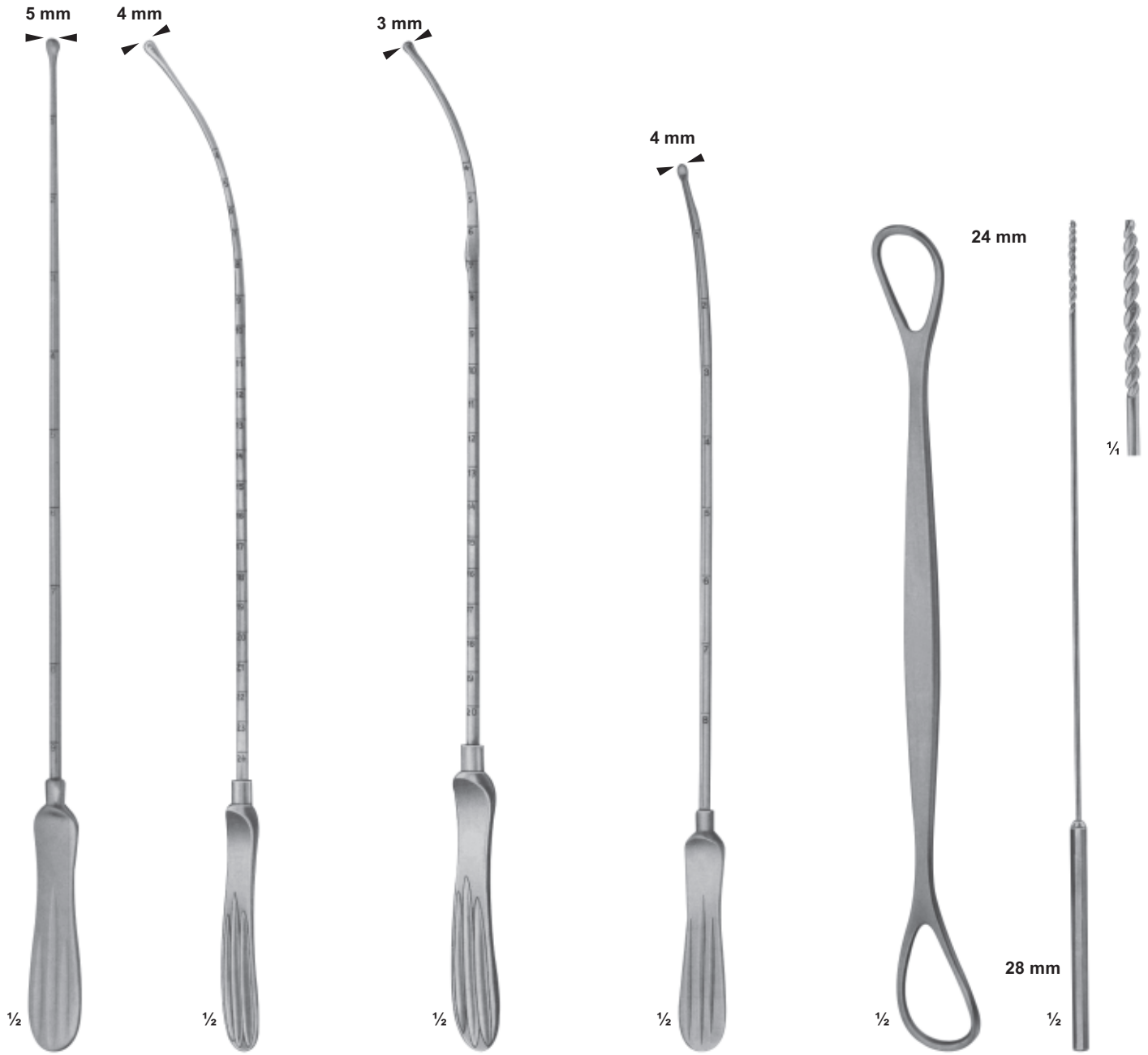

04-6202
MAYO
malleable
330 mm

04-6203
SIMS
malleable
330 mm
04-6204
SIMS
330mm

04-6205
MARTIN
330 mm

04-6206
SIMPSON
malleable
silver-plated
290 mm

04-6207
BRAUN
Uterine
depressor
270 mm

04-6208
Cotton
applicator
270 mm

Uterine Dressing Forceps

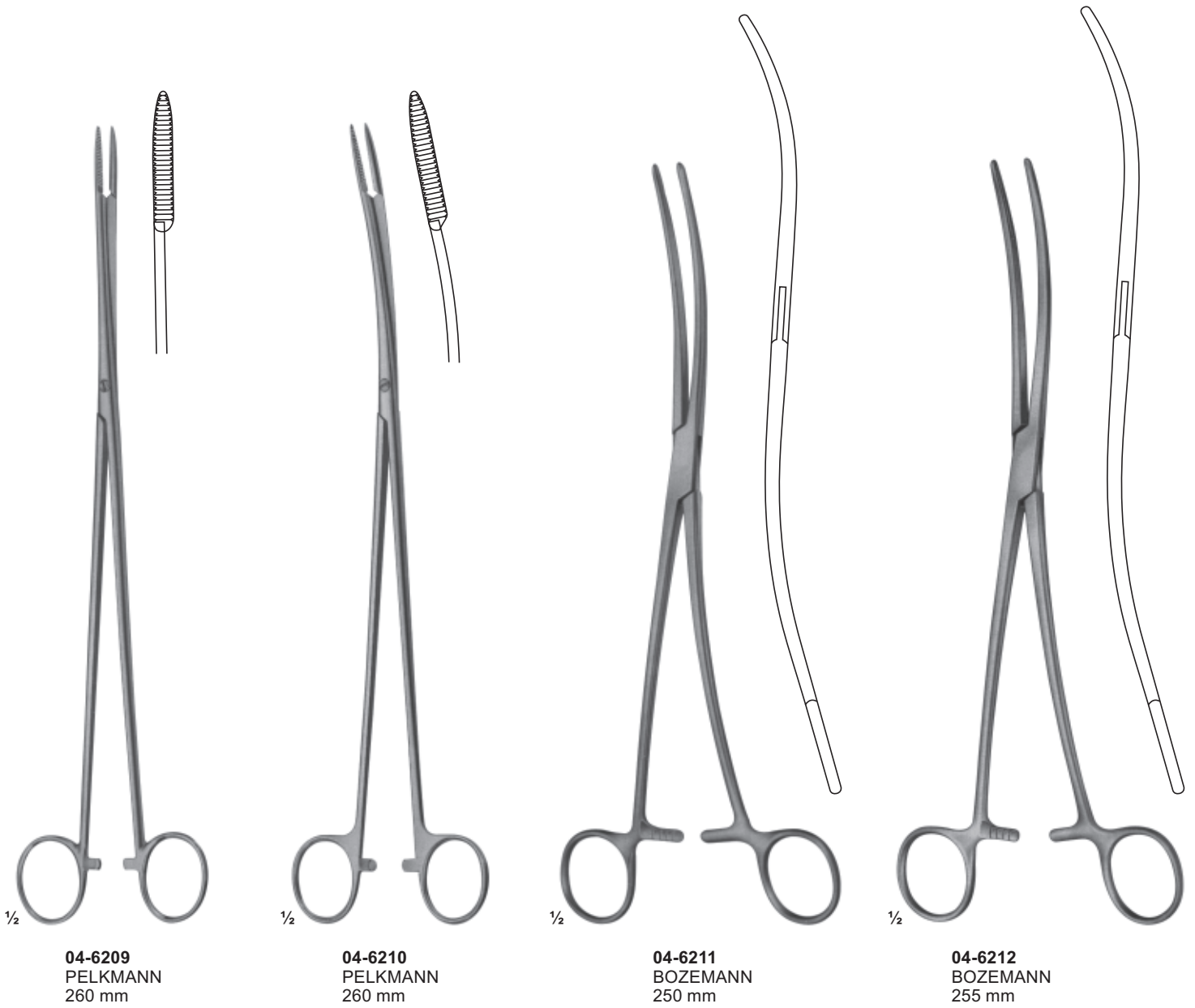

Jaws with longitudinal groove

Uterine Dressing Forceps

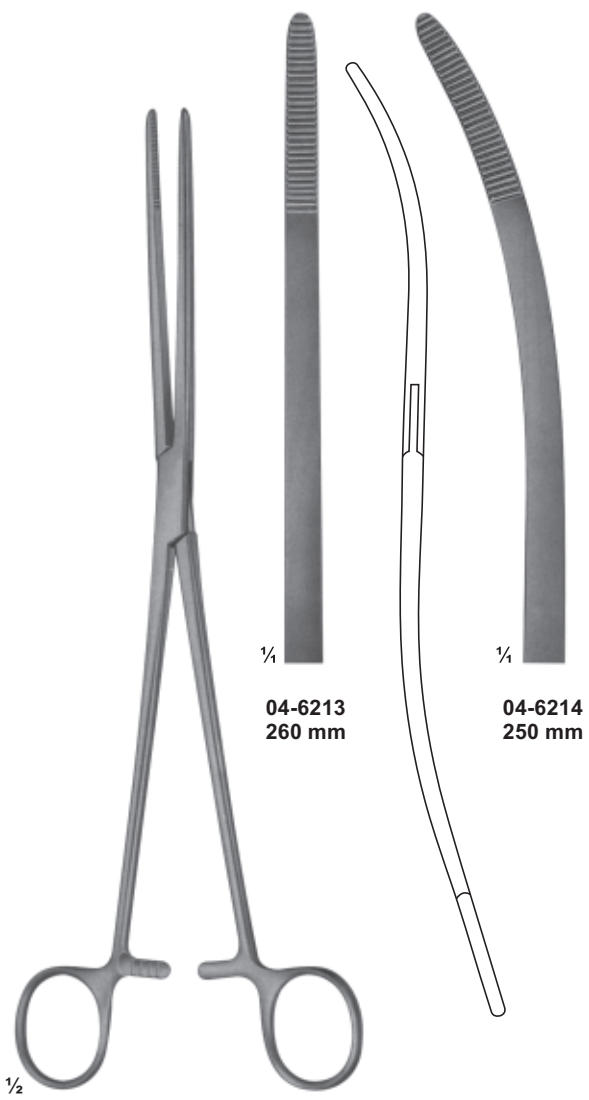

04-6213 - 04-6214
BOZEMANN



04-6215
BOZEMANN-DOUGLAS
260 mm

Uterine Tenaculum Forceps

Standard



04-6216
BRAUN
slender type
250 mm



04-6217
SCHROEDER
250 mm



04-6218
POZZI
heavy type
255 mm

Uterine Tenaculum Forceps

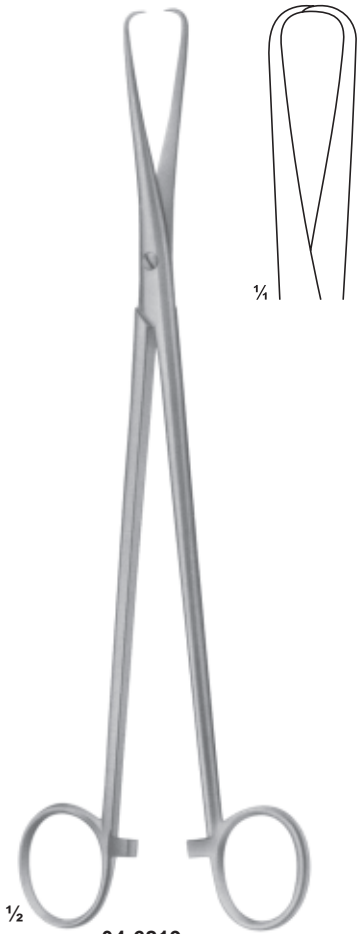

**04-6219
MARTIN**
265 mm

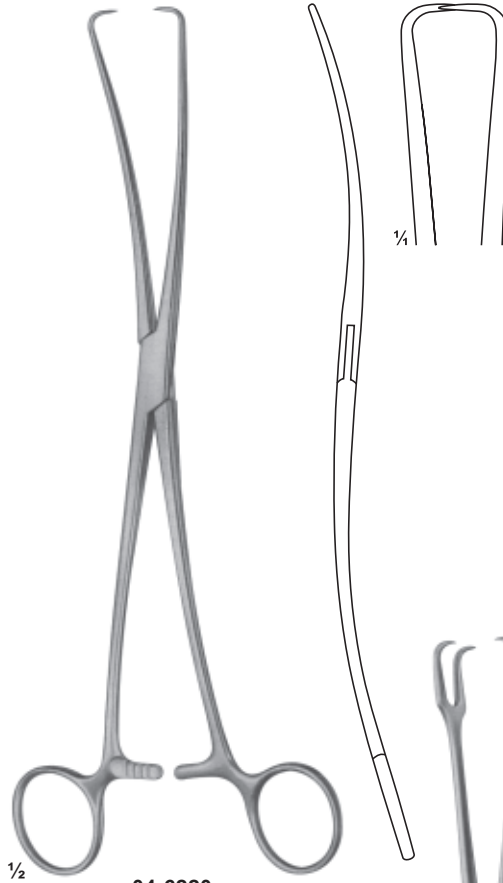

**04-6220
DUPLAY**
250 mm

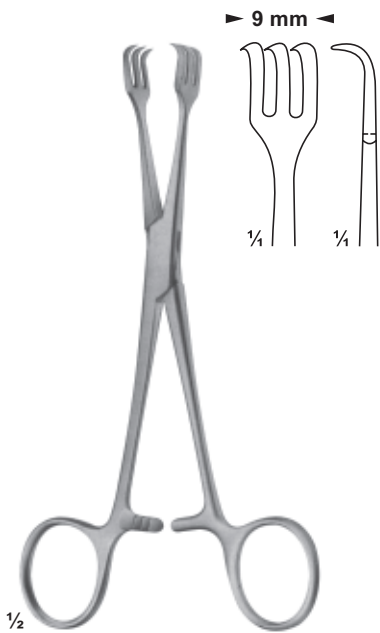
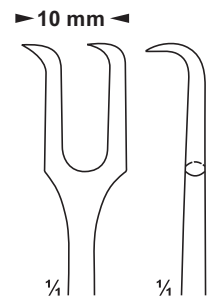

**04-6221
LAHEY**
155 mm

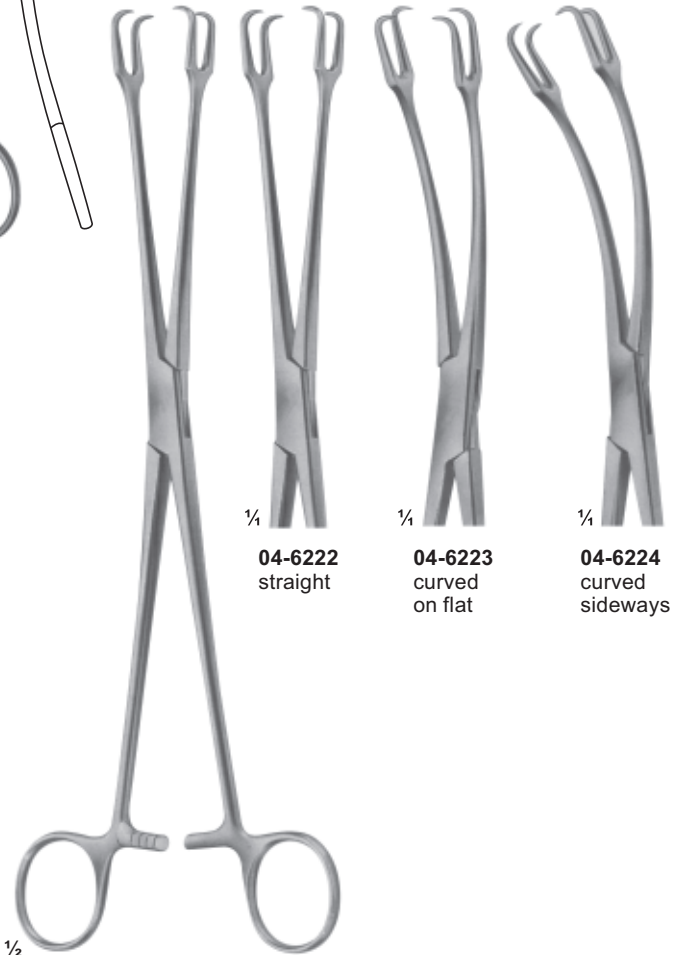

04-6222
straight

04-6223
curved
on flat

04-6224
curved
sideways

**04-6222 - 04-6224
SCHROEDER**
250 mm

Uterine Tenaculum Forceps

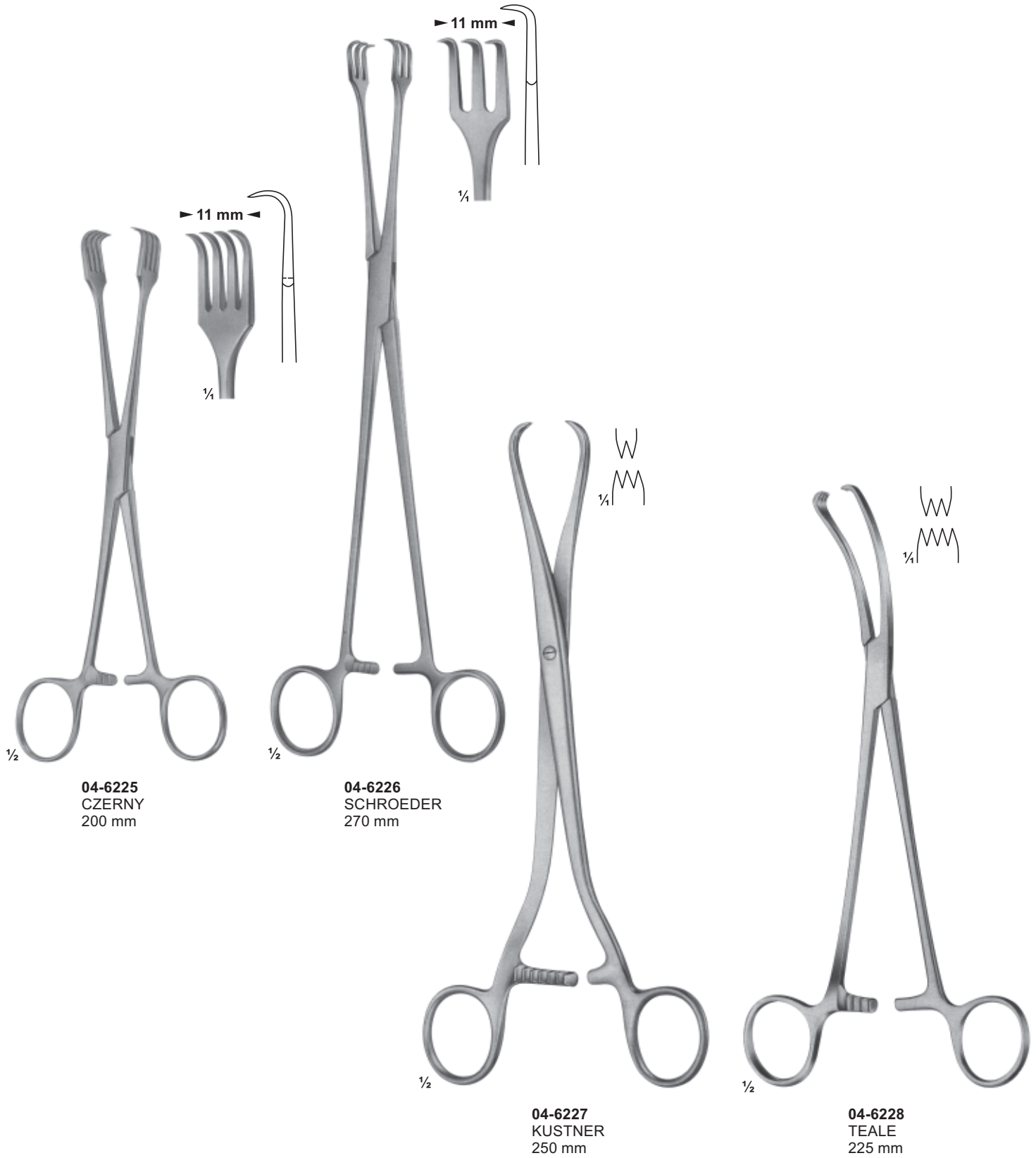

Uterine Tenaculum Forceps

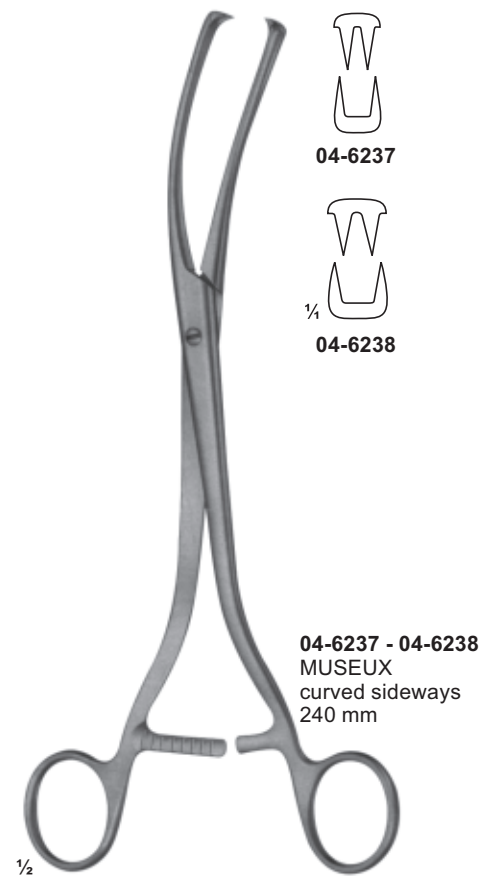
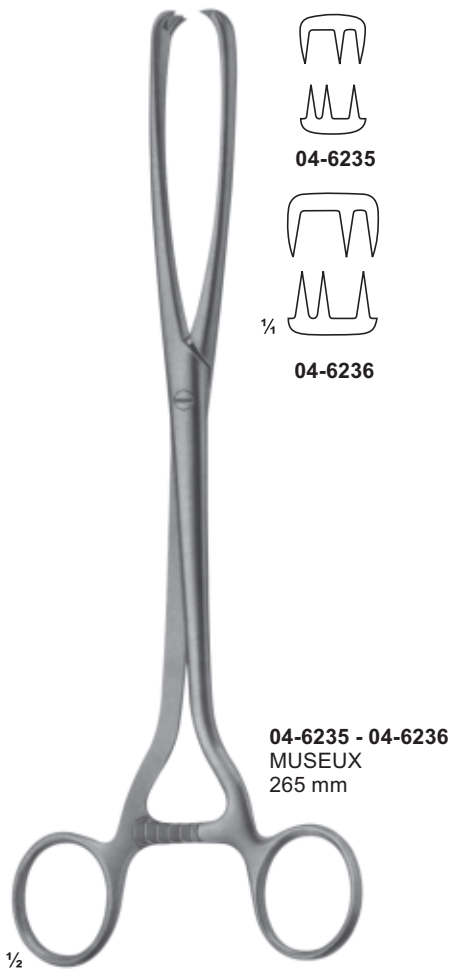
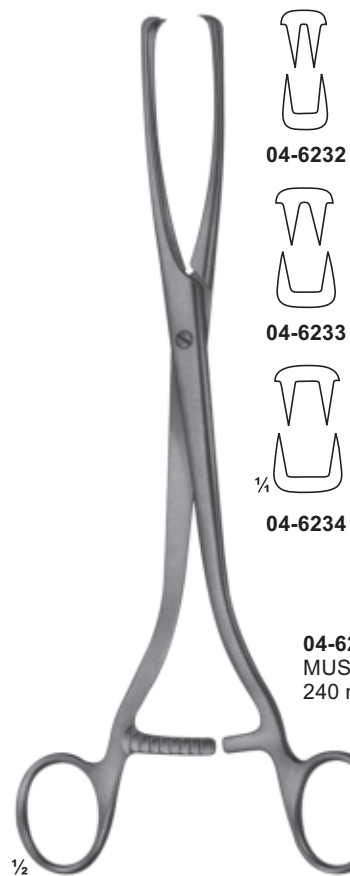

Polypus-and Ovum Forceps

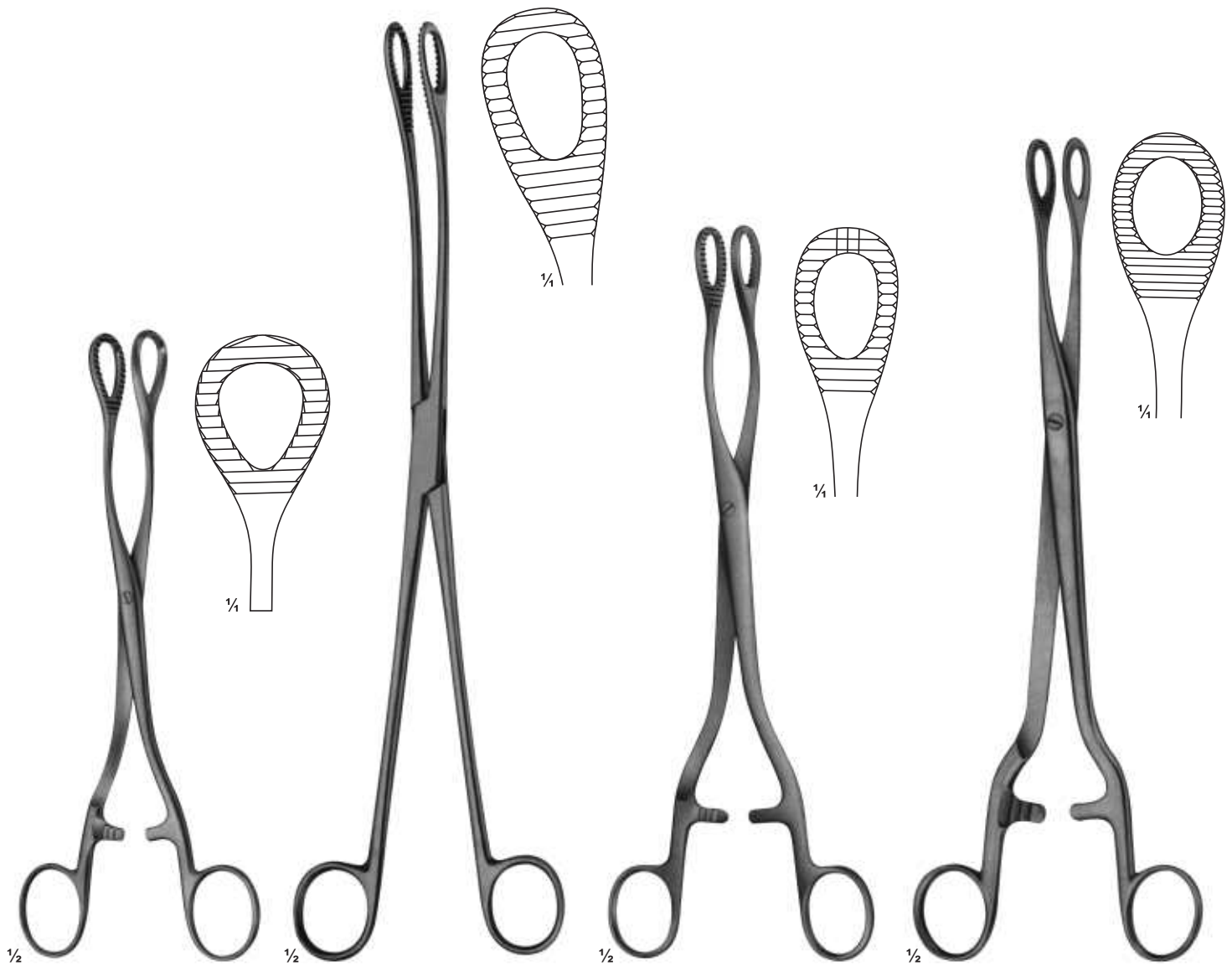

04-6239
HEYWOOD-SMITH
200 mm

04-6240
KELLY
320 mm

04-6241
HEYWOOD-SMITH
250 mm

04-6242
NOTO
280 mm

Atraumata



¼



¼



¼



¼

04-6244
250mm

04-6245
270mm



½

04-6243
DOYEN
185 mm



½

04-6244 - 04-6245



½

04-6246
BUMM
280 mm

Uterine Elevating Forceps

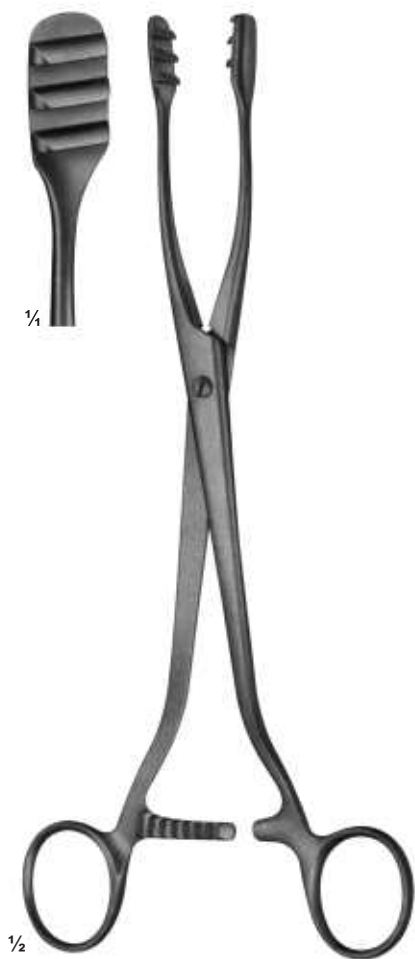

04-6247
COLLIN
250 mm



04-6248
COLLIN
285 mm



04-6249
DARTIGUES
255 mm

Uterine Elevating Forceps



04-6250
SOMER
235 mm



04-6251
STRASSMANN
265 mm

Uterine Elevating Forceps

With movable jaws



04-6252
COLLIN
265 mm

With movable jaws



04-6253
APPREX
approx. 260 mm

Myoma Instruments, Instruments For Micro Tubal Operations



04-6254
SEGOND
Myomatome
270 mm



04-6255
DOYEN
Myoma screw
150 mm



04-6256
DOYEN
Myoma screw
190 mm



04-6257 **04-6258** **04-6259**
Ø 6mm Ø 8mm Ø 10mm

04-6257 - 04-6259
NEUBUSER
Tubal seizing forceps
200 mm

145 X 100 X 1.5 mm



04-6263
Silicon operating pad
pre-cut



04-6260
Splint guide
with thread



04-6261
Splint guide with
round handle
180 mm



04-6262
Angled glass rods
Set . 3 pieces



04-6264
Polyaethylen splint material
soft-sterile
0.45 mm

Malleable



04-6266
Uterine
Secretion scoop
270 mm

Malleable

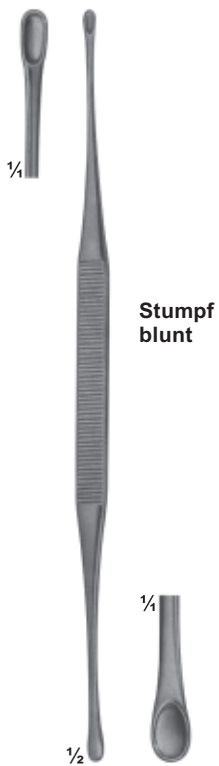

04-6265
ASCH
Uterine
Secretion scoop
200 mm



04-6267
NOVAK-SCHOECKAERT
Endometrial biopsy
curette
240 mm



04-6268
RANDALL
Endometrial
biopsy curette
240 mm

Biopsy Forceps

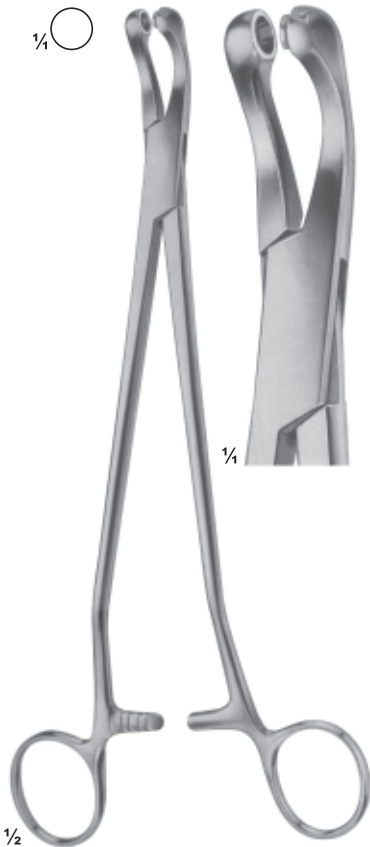

Biopsy Forceps

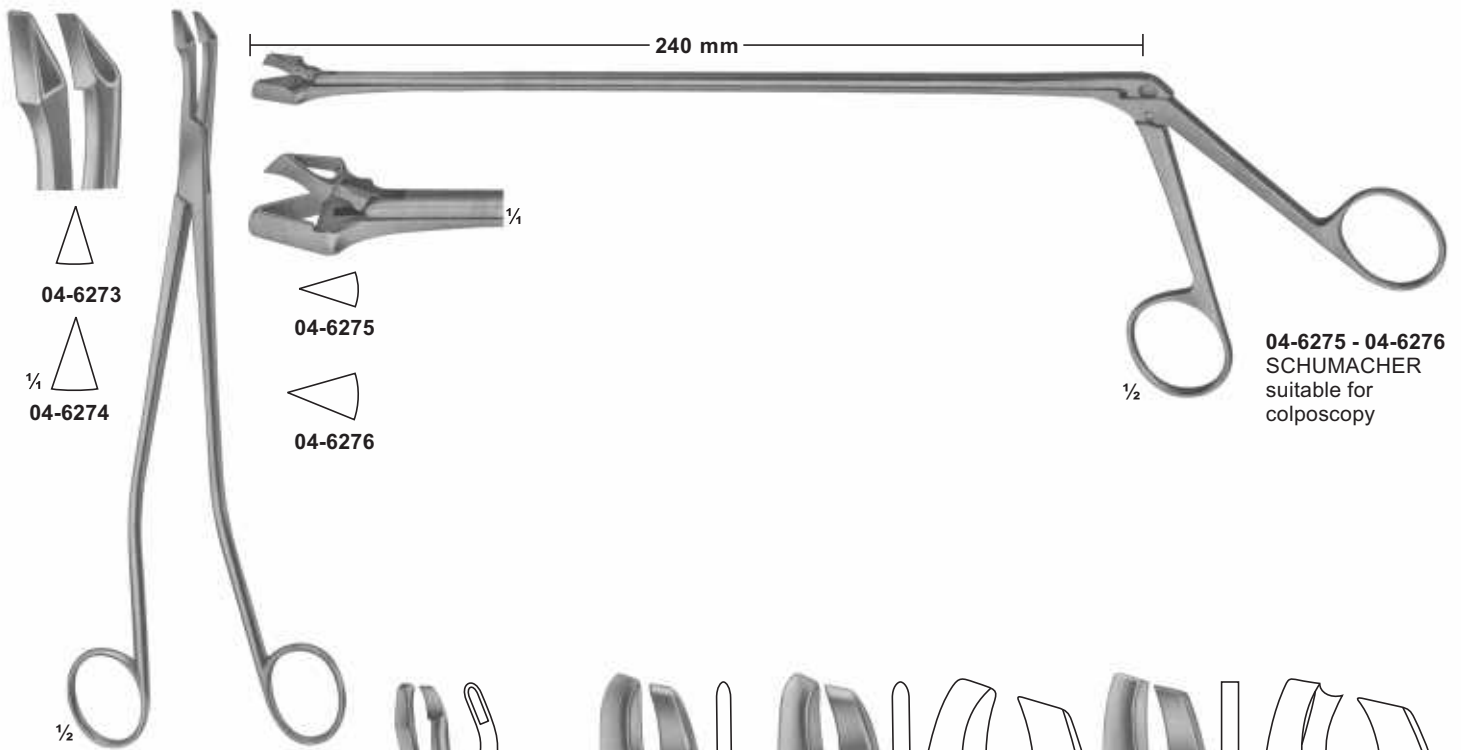

04-6273
04-6274

04-6275
04-6276

04-6275 - 04-6276
SCHUMACHER
suitable for
colposcopy

04-6273 - 04-6274
SCHUMACHER
240mm

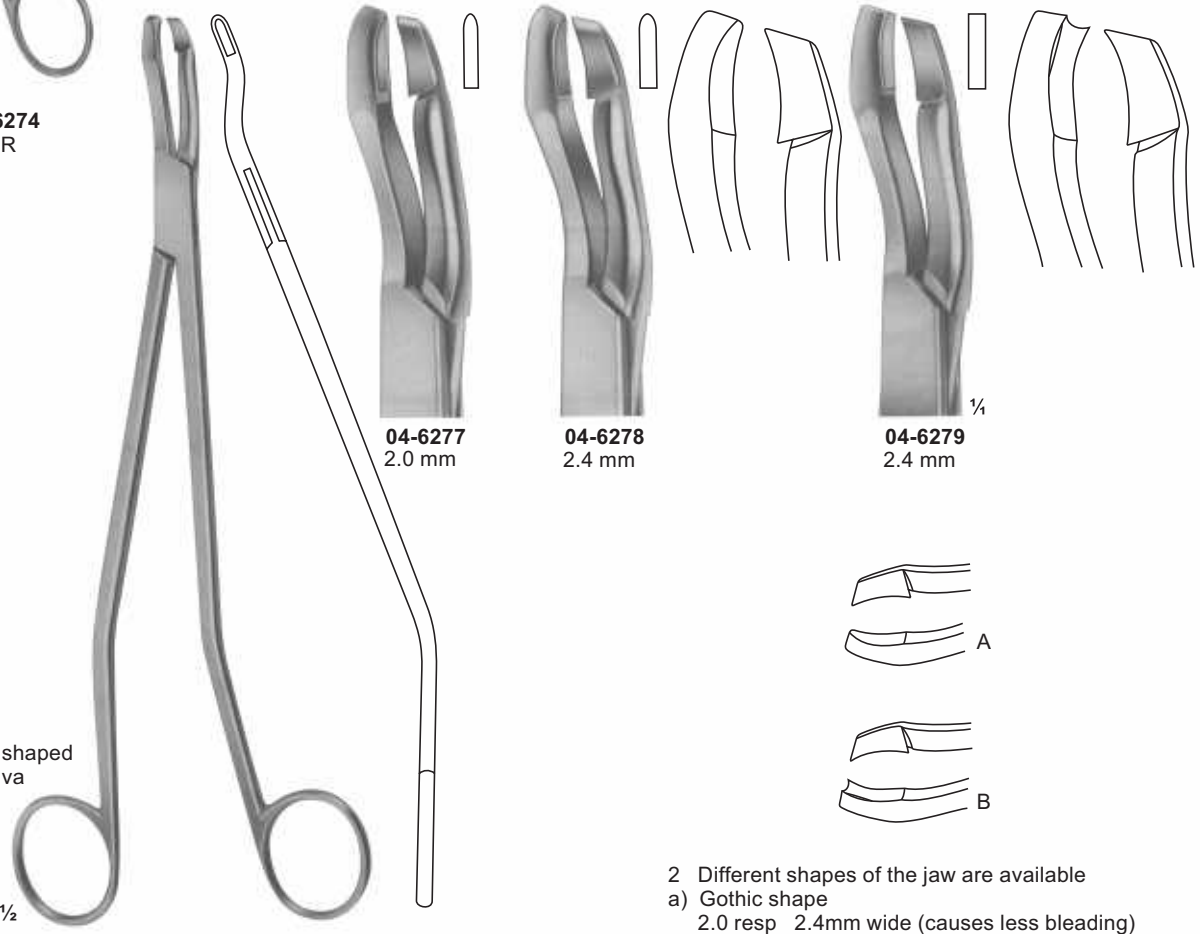

04-6277
2.0 mm

04-6278
2.4 mm

04-6279
2.4 mm

04-6277 - 04-6279
SEIDL DBP
Biopsy forceps, bayonet shaped
for portio, vagina and vulva
240mm

- 2 Different shapes of the jaw are available
- a) Gothic shape
2.0 resp 2.4mm wide (causes less bleeding)
- b) Rectangular shape, 2.4mm wide

Biopsy Forceps

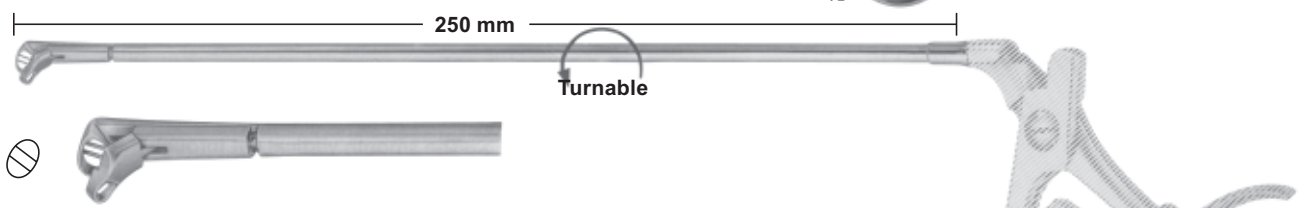
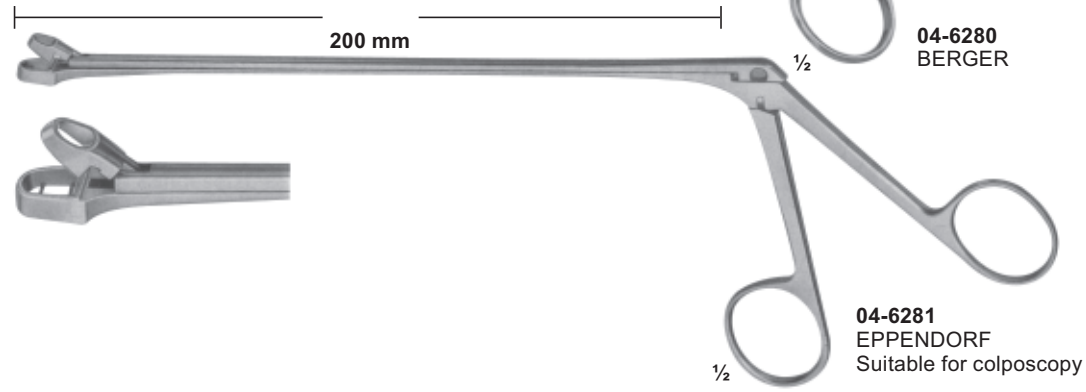
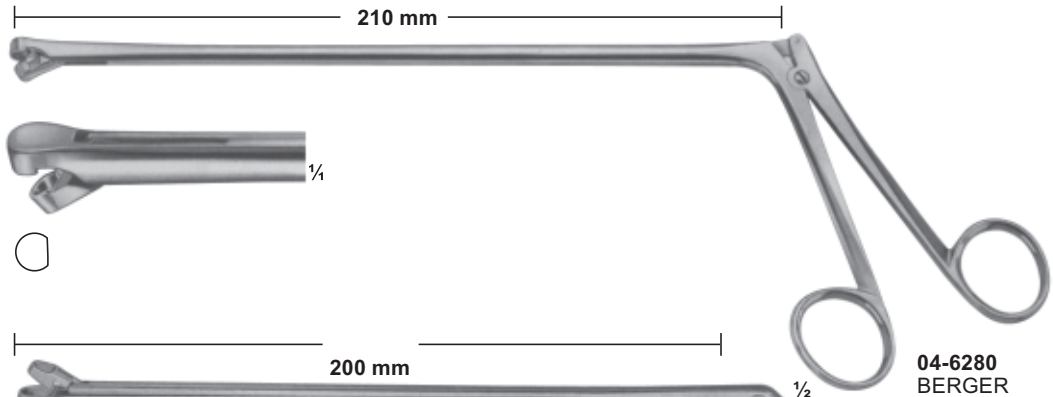

universal handle with drawing cut, beginning from the top 04-6283 attachment only 04-6282 for handle

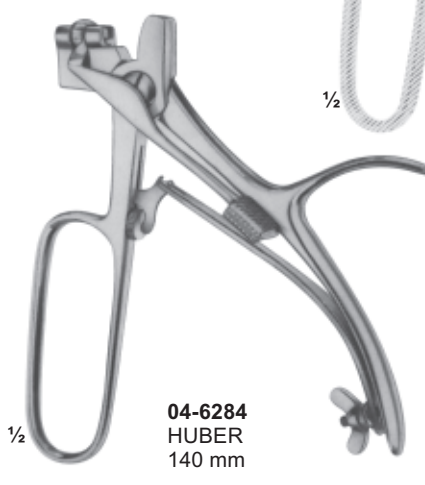

04-6282

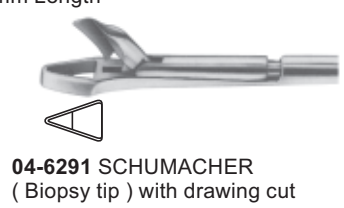
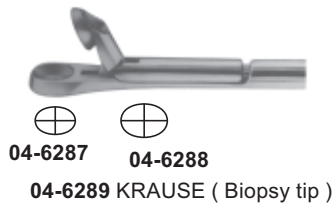

Uterine Scoops

Table of Recamier		Sharp		Blunt
Fig	Width	Rigid	Malleable	Rigid
00	4.5mm	04-6294		
0	7.5mm	04-6295		04-6306
1	8.5mm	04-6296	04-6317	04-6307
2	10.5mm	04-6297	04-6318	04-6308
3	12.0mm	04-6298	04-6319	04-6309
4	14.0mm	04-6299	04-6320	04-6310
5	15.0mm	04-6300	04-6321	04-6311
6	16.5mm	04-6301	04-6322	04-6312
7	18.0mm	04-6302	04-6323	04-6313
8	19.5mm	04-6303	04-6324	04-6314
9	21.5mm	04-6304		04-6315
10	23.5mm	04-6305		04-6316
04-6294 - 04-6305		Sharp - Rigid		
04-6317 - 04-6324		Sharp - Malleable		
04-6306 - 04-6316		Blunt - Rigid		

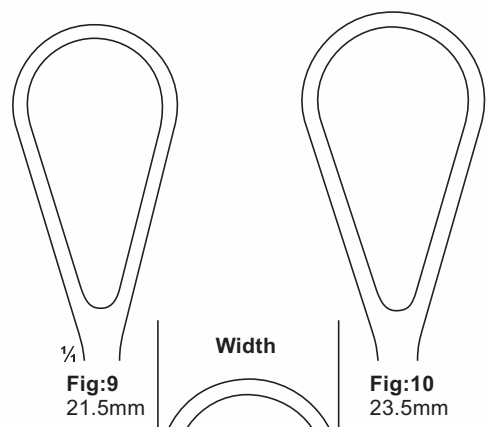
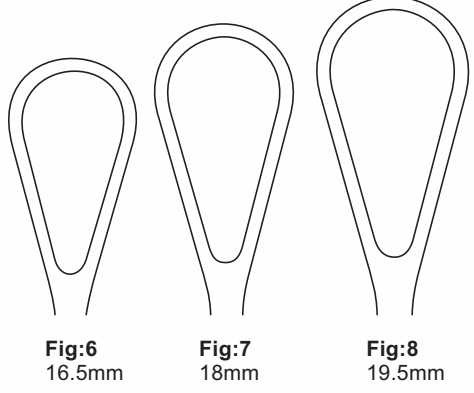
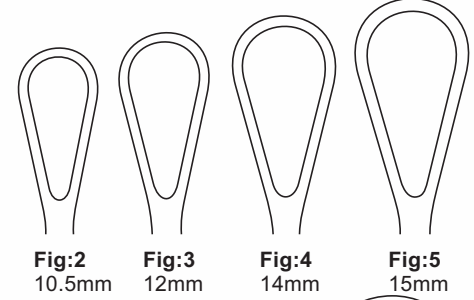
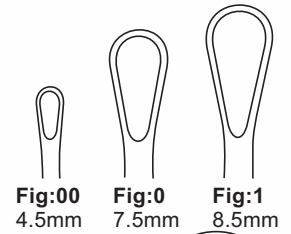

04-6292
SIMON
max.240 mm

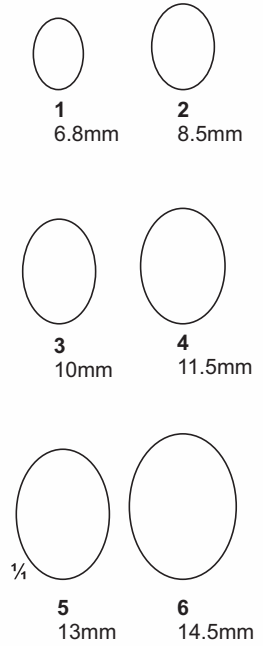

04-6293
SCHRODER
max.310 mm

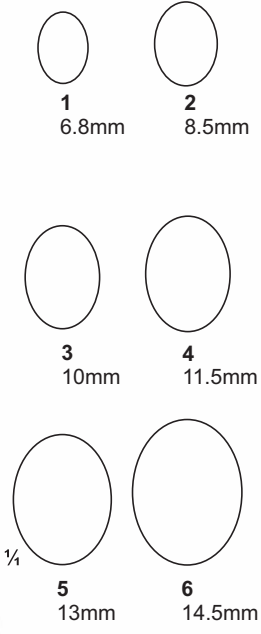

04-6294
RECAMIER
max.300 mm

Uterine Curettes

Fig	Width	Sharp		Blunt	
		Rigid	Malleable	Rigid	Malleable
1	7.5mm	04-6325	04-6331	04-6337	
2	8.5mm	04-6326	04-6332	04-6338	
3	10.5mm	04-6327	04-6333	04-6339	
4	12.0mm	04-6328	04-6334	04-6340	
5	14.0mm	04-6329	04-6335	04-6341	
6	15.0mm	04-6330	04-6336	04-6342	

04-6325 - 04-6330 Sharp - Rigid
 04-6331 - 04-6336 Sharp - Malleable
 04-6337 - 04-6342 Blunt - Rigid

Fig	Width	Blunt - Malleable
0	16.5mm	04-6343
1	18.5mm	04-6344
2	19.5mm	04-6345
3	21.5mm	04-6346
4	23.5mm	04-6347
5	26.0mm	04-6348
6	28.5mm	04-6349

BUMM

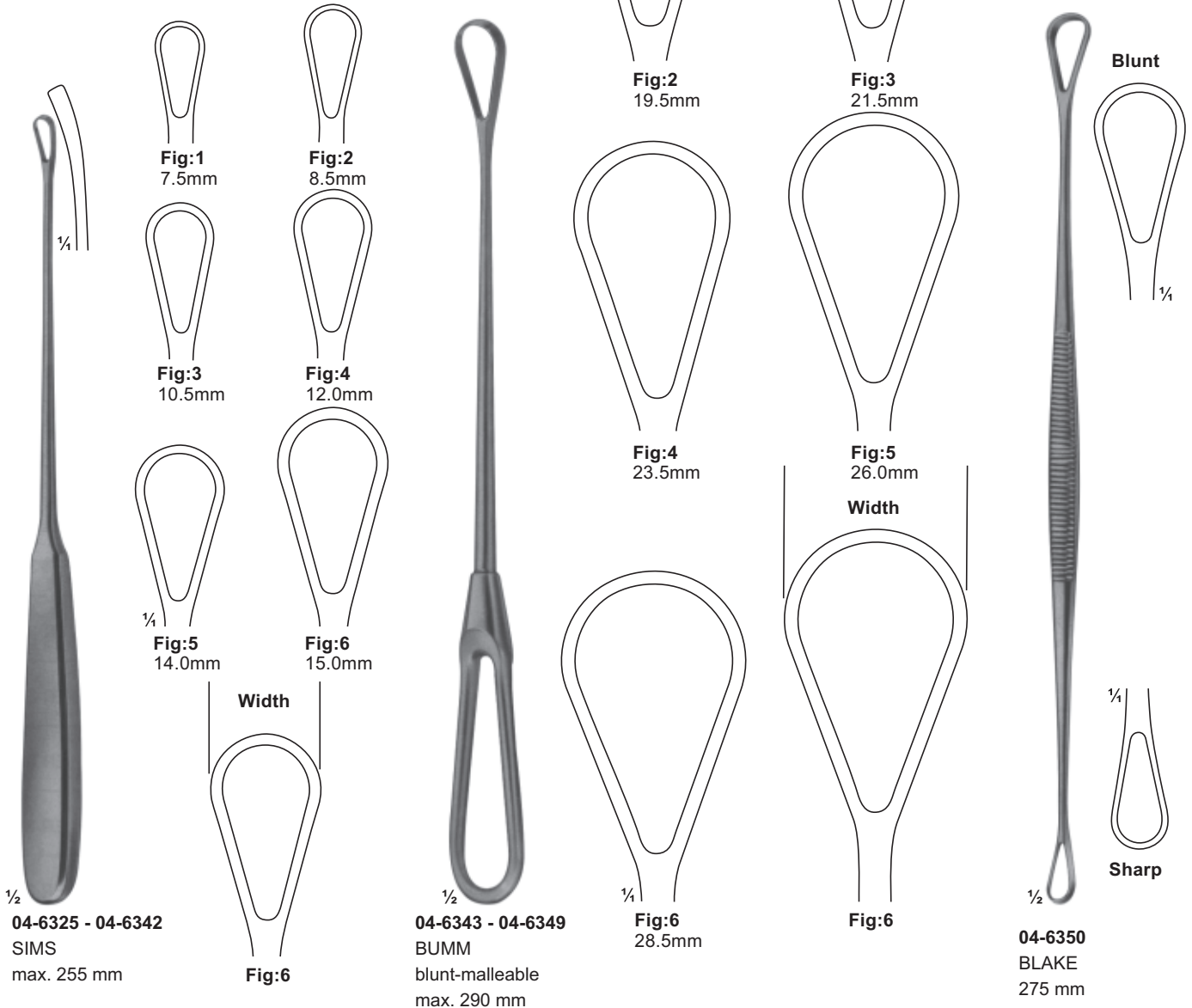

Placenta-and Ovum Curettes

Fig	Width	Sharp Malleable	Blunt Malleable
1	23.5mm	04-6354	04-6356
2	26.0mm		04-6357
3	28.5mm	04-6355	04-6358



04-6351
COLLIN
300 mm

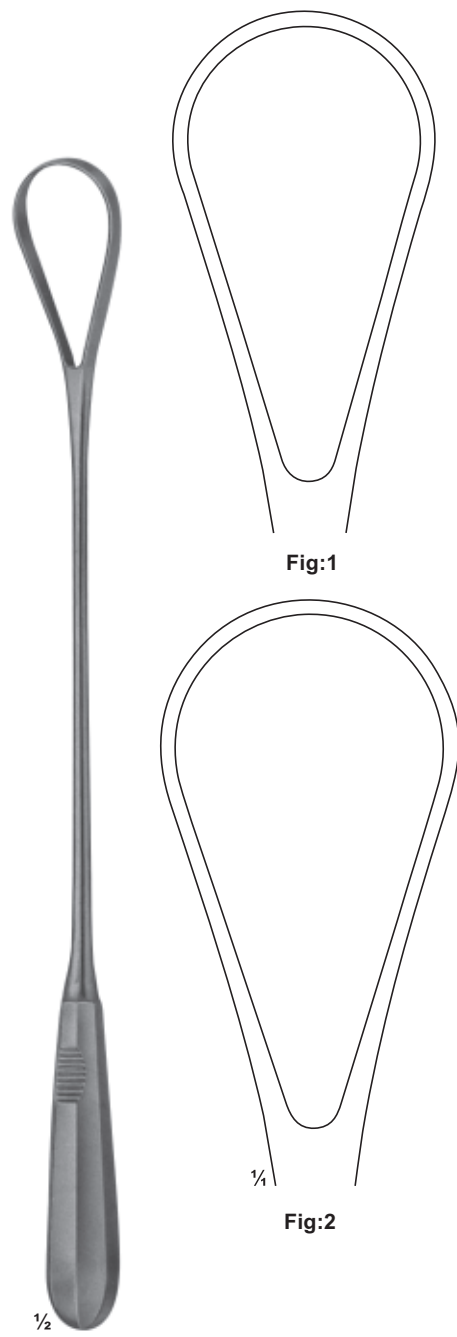

04-6352 - 04-6353
RECAMIER
blunt-rigid
max. 360 mm

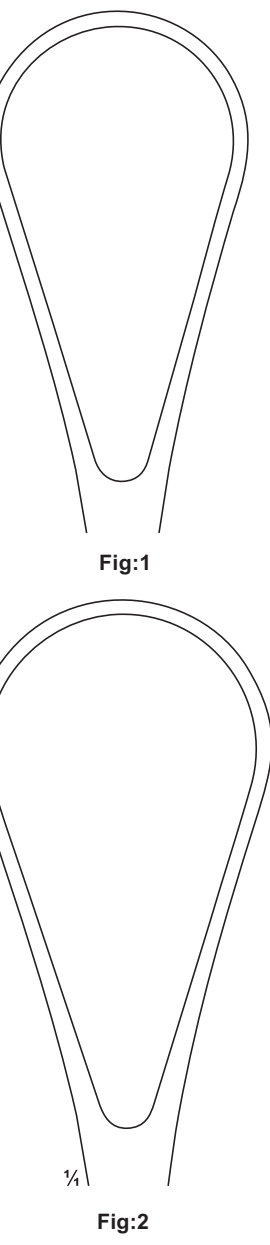
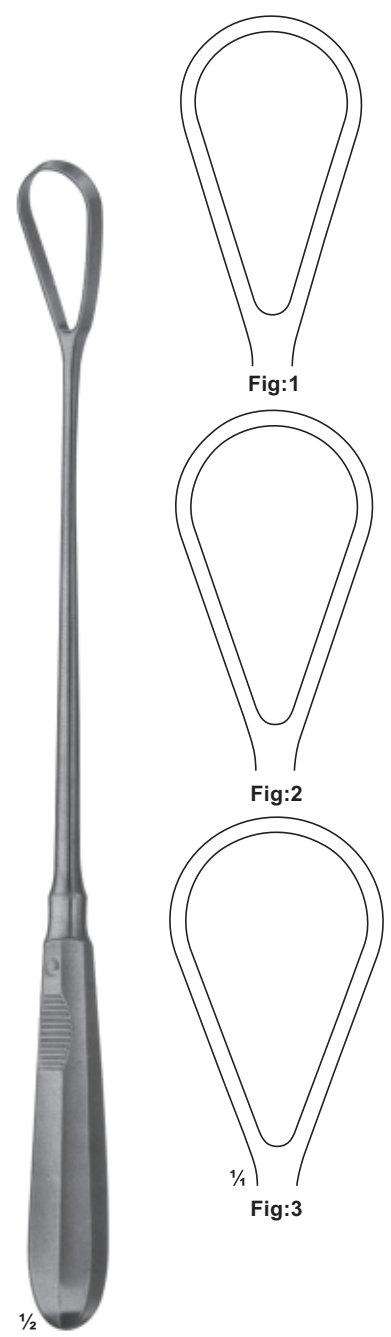

Fig	Width	Blunt Rigid
1	34.5mm	04-6352
2	39.5mm	04-6353



04-6354 - 04-6358
BUMM
max. 310 mm
04-6354 - 04-6355 sharp-malleable
04-6356 - 04-6358 blunt-malleable

Vacuum Currettes

04-6359 - 04-6364

Suction currettes, stainless steel, fitting hose connection.

Working tips are smoothly rounded off, therefore no danger of perforation.

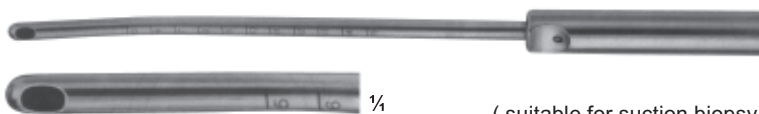

(suitable for suction biopsy)

04-6359: diam 4 mm

04-6360: diam 6 mm

04-6361: diam 8 mm

04-6362: diam 10 mm

04-6363: diam 12 mm

04-6364: diam 14 mm

04-6365

Hose connection inside diam. 11 mm, curved, stainless steel.

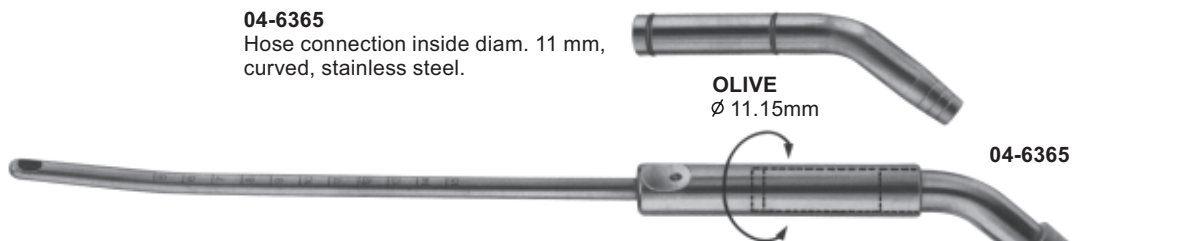

OLIVE
Ø 11.15mm

04-6365

04-6366

The new connection between suction curette and hose connection, **(04-6365)** Guarantees quick changing and free turning of the suction currettes on the hose connection.

04-6366

Transparent suction hose 1.8 mm long, inside diam 11 mm, outside diam 16.5 mm can be sterilized in an autoclave at 1 bar overpressure (120° C)

04-6367

Strainer for tissues, plastic, for single use only, to be used for histopathological examination.



04-6367



04-6368 diam 8 mm
04-6369 diam 10 mm
 BOZEMANN-FRITSCH
 Uterine Flushing Tube
 350 mm

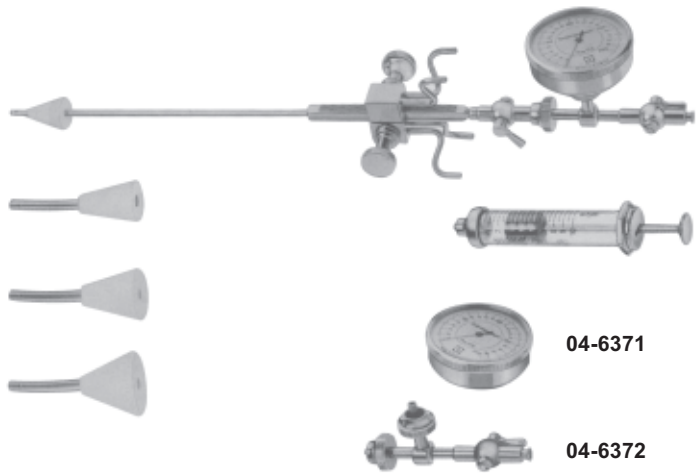

04-6371

04-6372

- 04-6370**
SCHULZE
Salpingograph, for utero-salpingography
in wooden case, consisting of:
- 04-6371** Manometer only
- 04-6372** Connection only, without manometer
- 04-6373** Uterine cannula with tape without cone
- 04-6374** Cone only, small
- 04-6375** Cone only, medium
- 04-6376** Cone only, large
- 04-6377** Record syringe, 10CC, luer-lock mount.

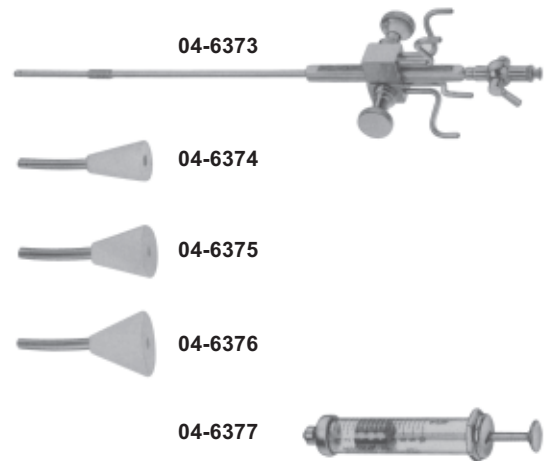

04-6373

04-6374

04-6375

04-6376

04-6377

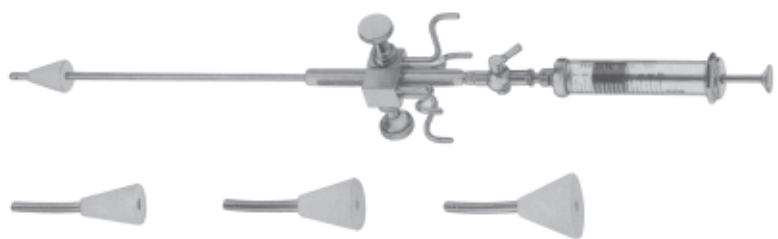

04-6378
SCHULZE
Salpingograph, equipment like(04-6370)
but without manometer.



04-6379
THOLE
 for internal and external measurements, graduated in centimeters

1/3



1/2

04-6380
DE LEE
 graduated in centimeters and inches



1/3

04-6381
COLLIN
 graduated in centimeters



1/3

04-6382
MARTIN
 graduated in centimeters



1/3



for internal measurements between symphysis and promontory

04-6383
SCHNEIDER
 graduated in centimeters

The additional straight arm can be replaced. The pelvimeter with straight arm is used for localisation of the portio vaginalis uteri and of vaginal metastasis.



1/3

04-6384
BREISKY
 graduated in centimeters

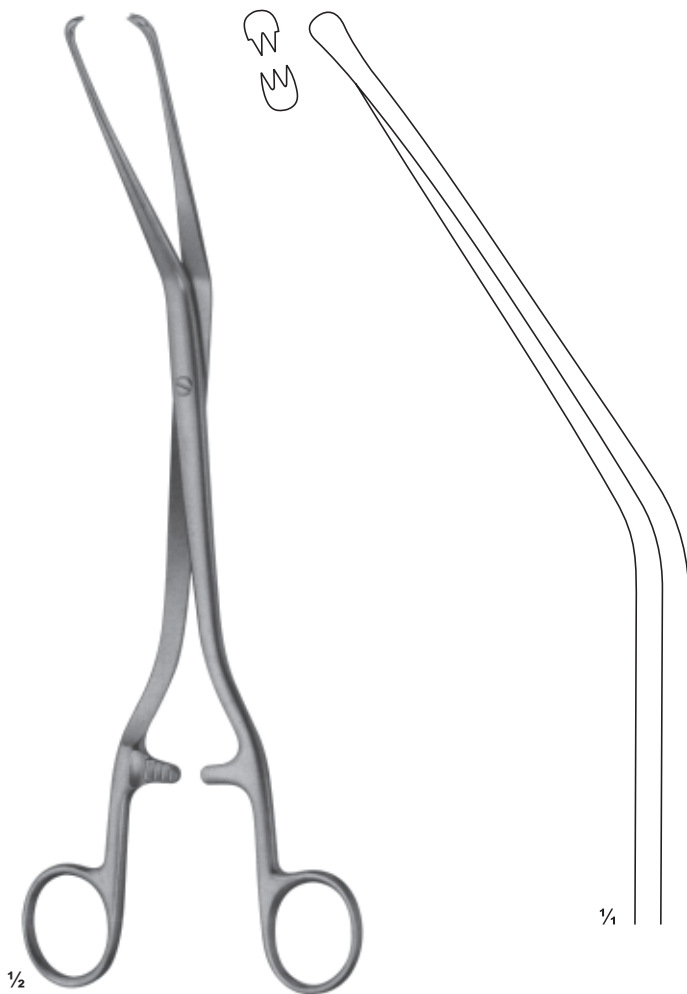

04-6385
HERFF
membrane puncturing
forceps
255 mm



04-6386
IOWA
membrane puncturing
forceps
260 mm



04-6387
SCHUMACHER
Umbilical cord
scissors
155 mm



04-6388
Umbilical cord
scissors
105 mm

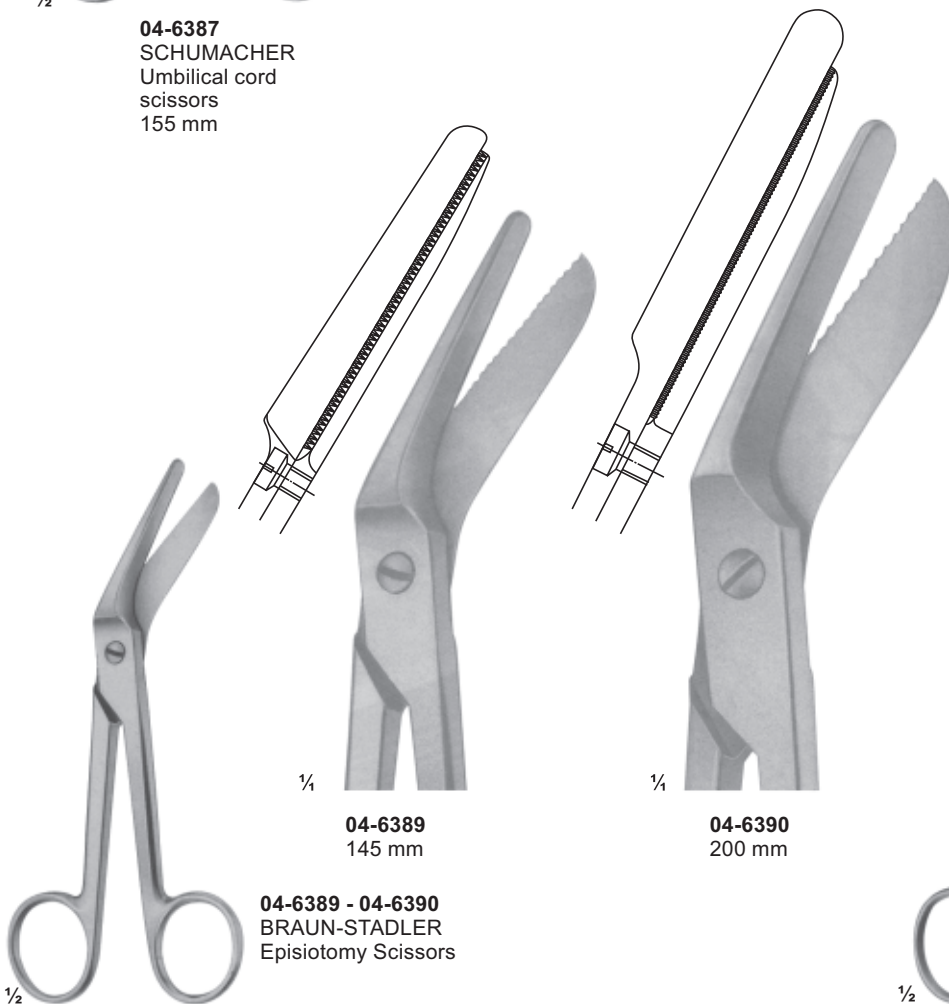

04-6389
145 mm

04-6390
200 mm

04-6389 - 04-6390
BRAUN-STADLER
Episiotomy Scissors

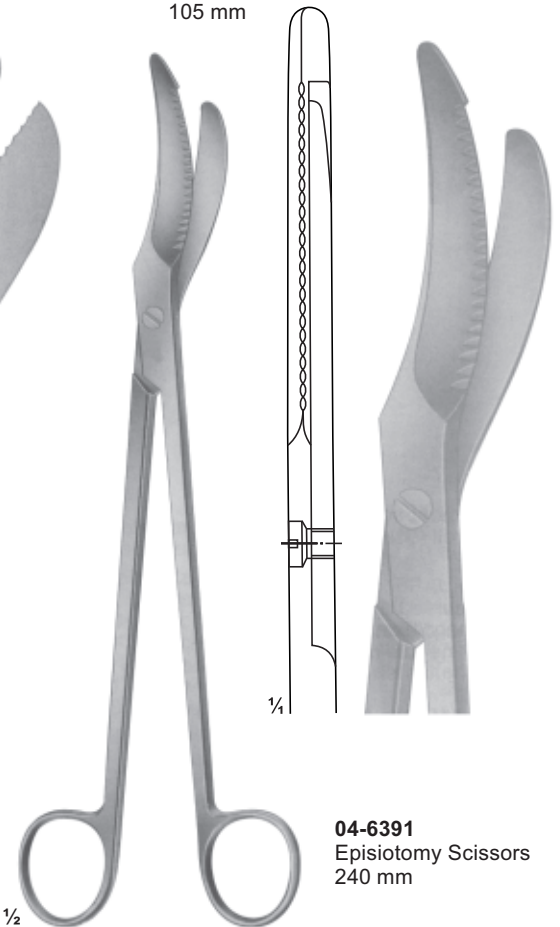

04-6391
Episiotomy Scissors
240 mm



04-6392
NAEGELE
355 mm



04-6393
NAEGELE
400 mm



04-6394
SIMPSON-BRAUN
305mm



1/3

04-6395
SIMPSON-BRAUN
350mm

For caesarean section



1/3

04-6396
SIMPSON
235mm

For caesarean section

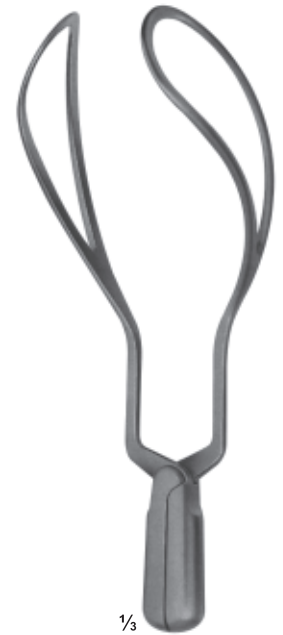

1/3

04-6397
WRIGLEY
250 mm

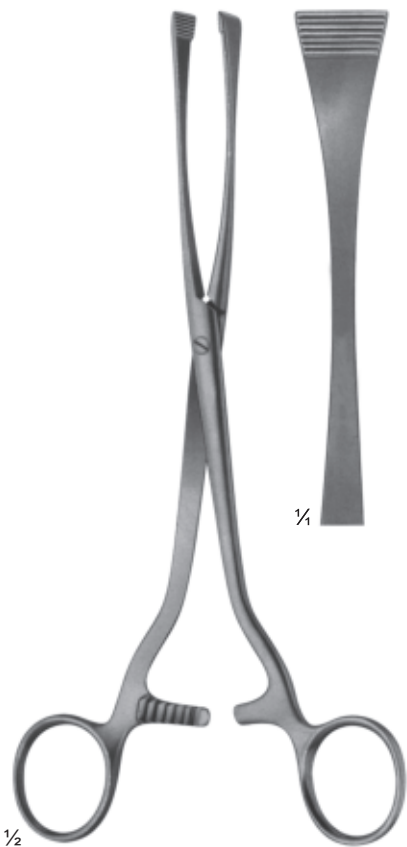

04-6398
GREEN-ARMYTAGE
 Caesarean section haemostatic
 forceps, for edges of the transverse
 incision in the lower segment
 220 mm

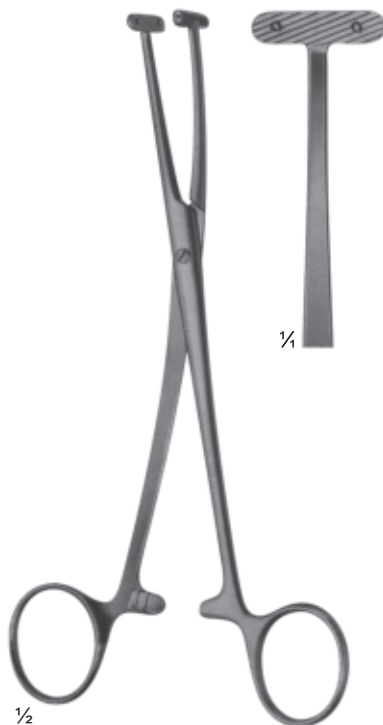

04-6399
WILLETT
 Scalp Flap forceps
 185 mm



04-6400
GAUSS
 Scalp Flap forceps
 260 mm

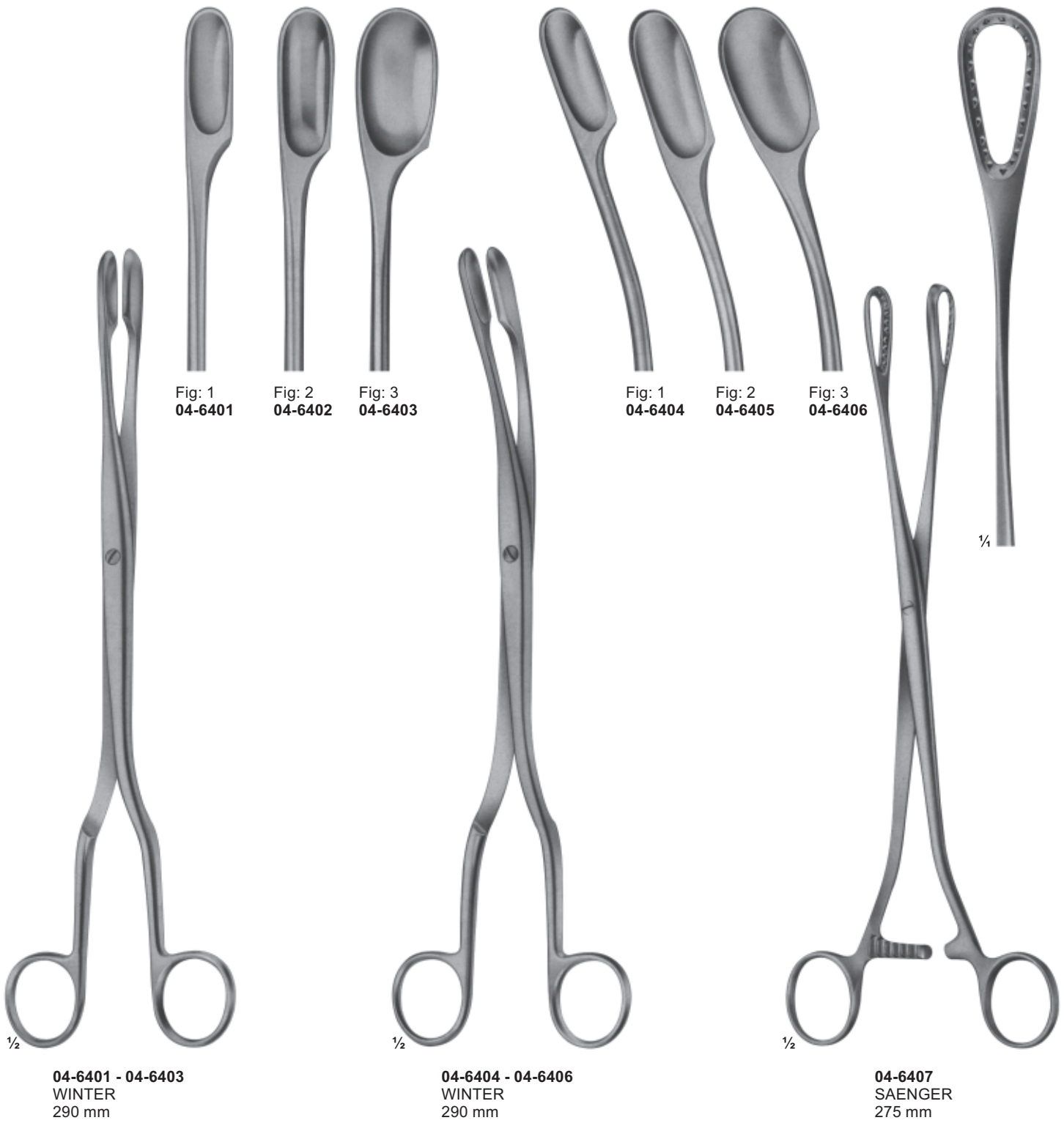

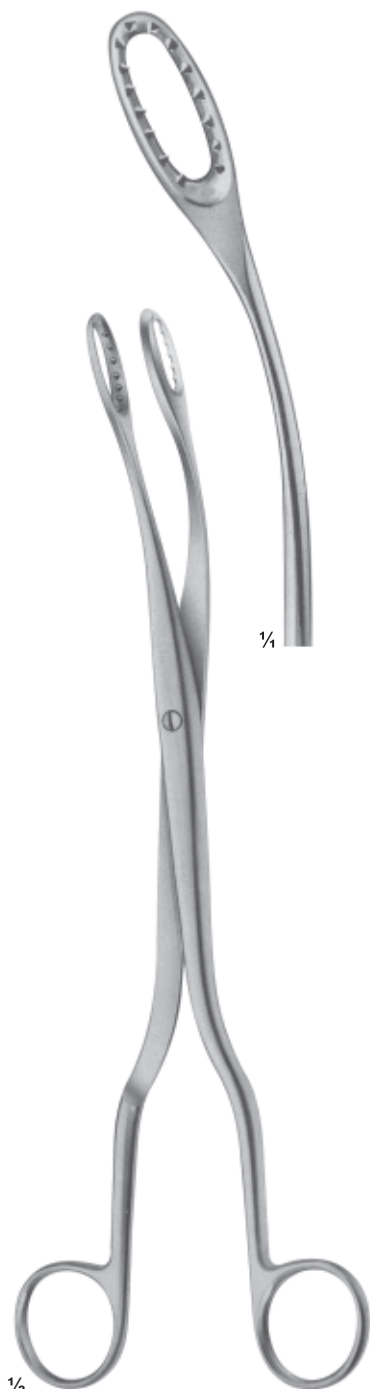

04-6408
SAENGER
285 mm

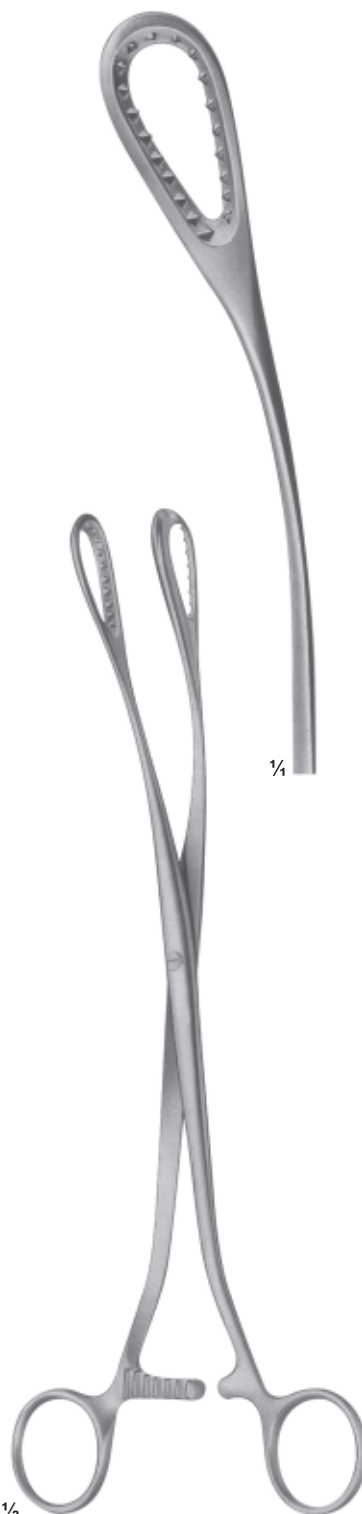

04-6409
SAENGER
265 mm



$\frac{1}{4}$
04-6410

04-6411



$\frac{1}{2}$
04-6410 - 04-6411
LEWKOWITZ
245 mm

Obstetrics-Placenta and Ovum Forceps,
Perforator, Cranioclast

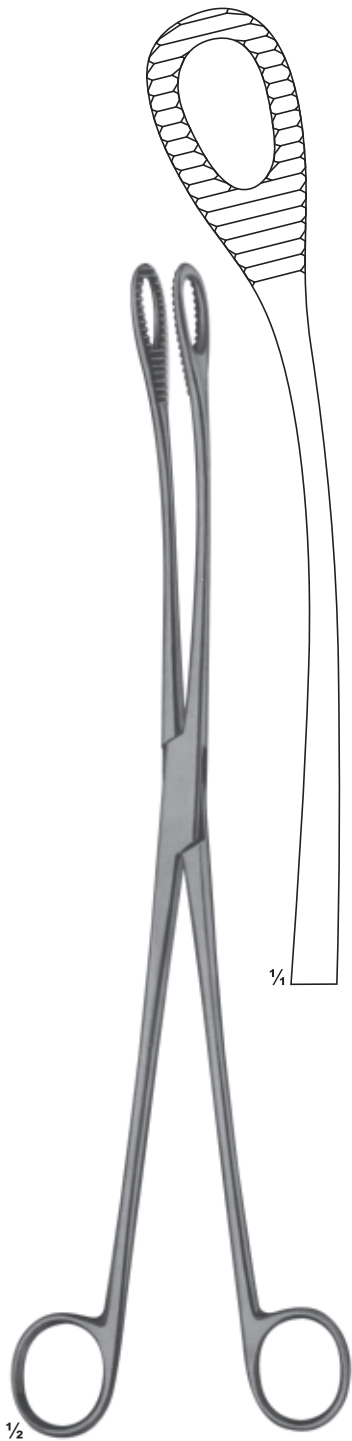

04-6412
KELLY
320mm













04-6413
SMELLIE
Perforator
270mm

1 jaws fenestrated



04-6414
BRAUN
Cranioclast
420mm

Tracheal Tubes with inner tubes

Fig.	0	1	2	3	4	5	6	7	8	9	10
											
∅ mm	4	5	6	7	8	9	10	11	12	13	14
Charr./Fr.	12	15	18	21	24	27	30	33	36	39	42



½

05-7001
UECKERMANN-DENKER
Cryothyrotomy trocar
with silver cannula
130mm

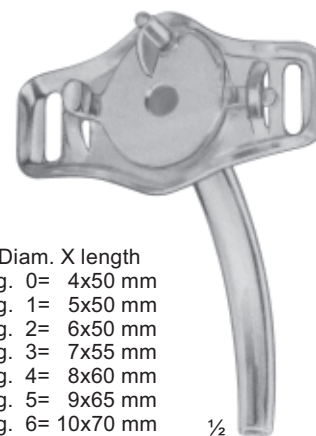

½

Diam. X length
05-7002 Fig. 0= 4x50 mm
05-7003 Fig. 1= 5x50 mm
05-7004 Fig. 2= 6x50 mm
05-7005 Fig. 3= 7x55 mm
05-7006 Fig. 4= 8x60 mm
05-7007 Fig. 5= 9x65 mm
05-7008 Fig. 6= 10x70 mm
05-7009 Fig. 7= 11x80 mm
05-7010 Fig. 8= 12x85 mm
05-7011 Fig. 9= 13x90 mm
05-7012 Fig. 10=14x90 mm

05-7002 - 05-7012
LUER
German silver



½

05-7013 - 05-7022
JACKSON
German Silver

Diam. X length
05-7013 Fig. 0= 4x50 mm
05-7014 Fig. 1= 5x48 mm
05-7015 Fig. 2= 6x58 mm
05-7016 Fig. 3= 7x70 mm
05-7017 Fig. 4= 8x78 mm
05-7018 Fig. 5= 9x84 mm
05-7019 Fig. 6= 10x84 mm
05-7020 Fig. 7= 11x86 mm
05-7021 Fig. 8= 12x88 mm
05-7022 Fig. 9= 13x90 mm



½

Diam. X length **05-7023 - 05-7032**
05-7023 Fig. 1= 5x48 mm JACKSON
05-7024 Fig. 2= 6x58 mm Stainless Steel
05-7025 Fig. 3= 7x70 mm
05-7026 Fig. 4= 8x78 mm
05-7027 Fig. 5= 9x84 mm
05-7028 Fig. 6= 10x84 mm
05-7029 Fig. 7= 11x86 mm
05-7030 Fig. 8= 12x88 mm
05-7031 Fig. 9= 13x90 mm
05-7032 Fig.10= 14x90 mm

Wound-and Tracheal Hooks and Dilators

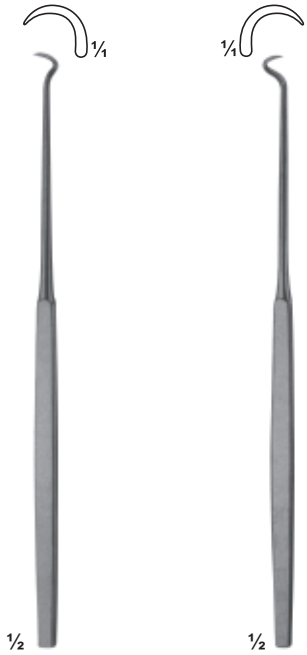

05-7033
BOSE
165 mm

05-7034
BOSE
165 mm

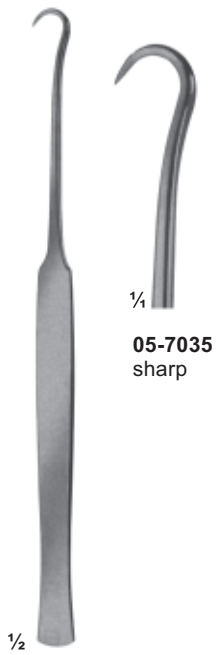

05-7035 - 05-7037
180 mm

05-7035
sharp



05-7036
blunt

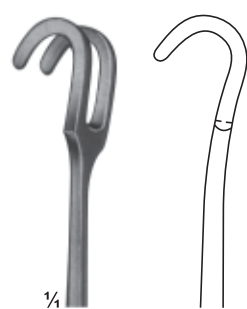

05-7037
blunt



05-7038
FINSEN
50 mm

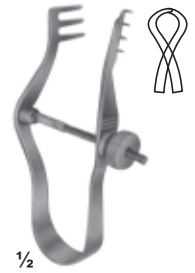

05-7039
FINSEN
70 mm



05-7040
TROUSSEAU
120 mm



05-7041
LABORDE
125 mm



05-7042
LABORDE
strong pattren
135 mm



05-7043
Cleaning Brush
for tracheal tubes
285 mm

Irrigating Cannulae, Embolus Grasping Forceps, Dilators

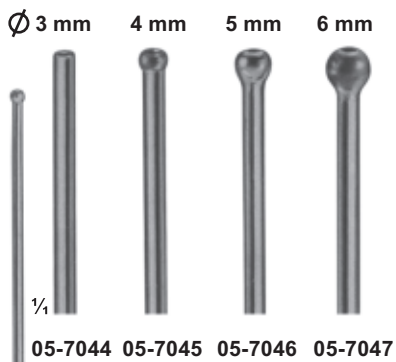

05-7044 - 05-7047
SCHMID
 Vessel irrigating cannulae,
 malleable, silver plated
 150 mm

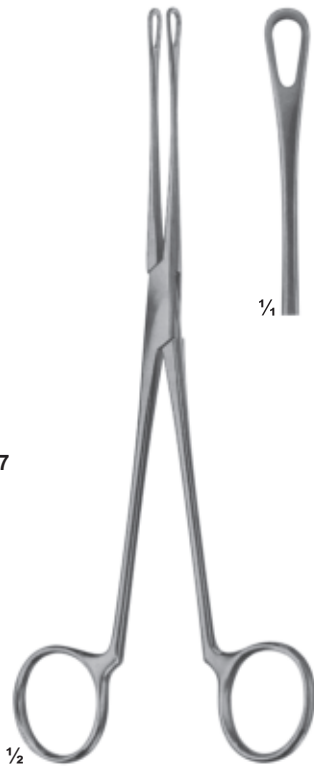

05-7048
BLAKE
 Embolus grasping
 forceps
 205 mm

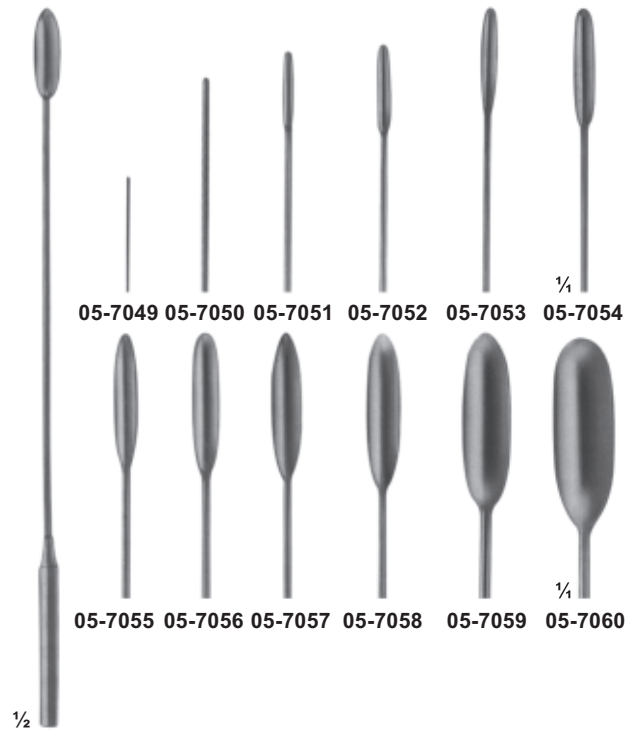

05-7049 - 05-7060
DE BAKEY
 Vascular dilators,
 malleable
 190 mm

05-7049 0,5 mm Ø	05-7055 3,5 mm Ø
05-7050 1,0 mm Ø	05-7056 4,0 mm Ø
05-7051 1,5 mm Ø	05-7057 4,5 mm Ø
05-7052 2,0 mm Ø	05-7058 5,0 mm Ø
05-7053 2,5 mm Ø	05-7059 7,0 mm Ø
05-7054 3,0 mm Ø	05-7060 9,0 mm Ø

Vascular Spatulas

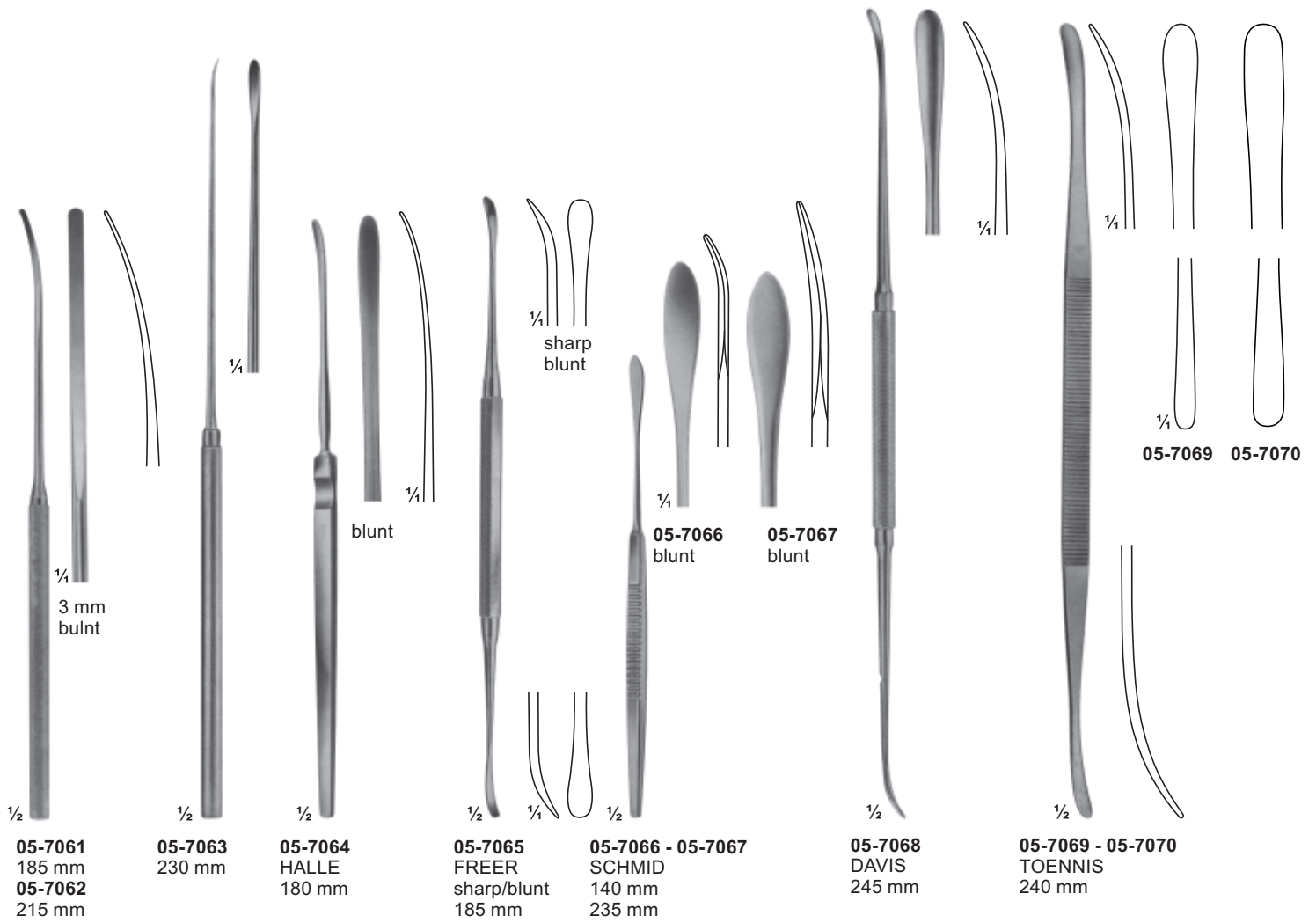

Endarterectomy Strippers, Tourniquets

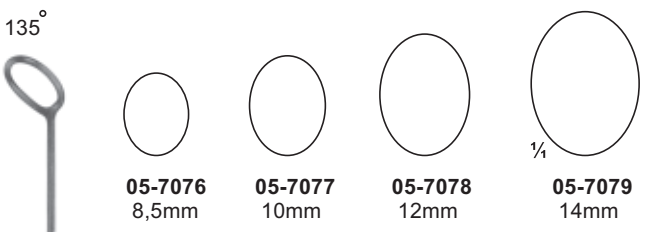
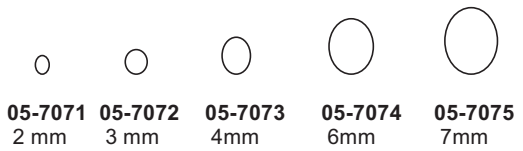

1/2
 05-7071 - 05-7079
 Endarterectomy strippers
 550 mm



1/2
 05-7080
 Handle for
 110 mm



1/2
 05-7081 - 05-7082
 RUMEL-BELMONT
 325 mm
 05-7081 - 4,0 mm Ø
 05-7082 - 6,4 mm Ø



1/4
 05-7083 05-7084
 Guide only

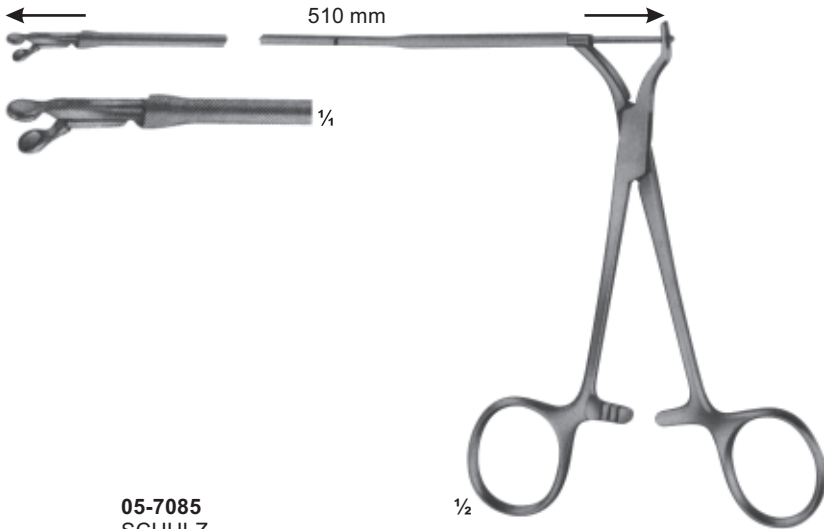

**05-7085
SCHULZ**
Bioptome, with flexible Shaft, 510 mm long,
with round jaws 3 mm diam.

Biopsy forceps, for biopsy from the right atrium
through cava jugularis, prior to heart implantations.

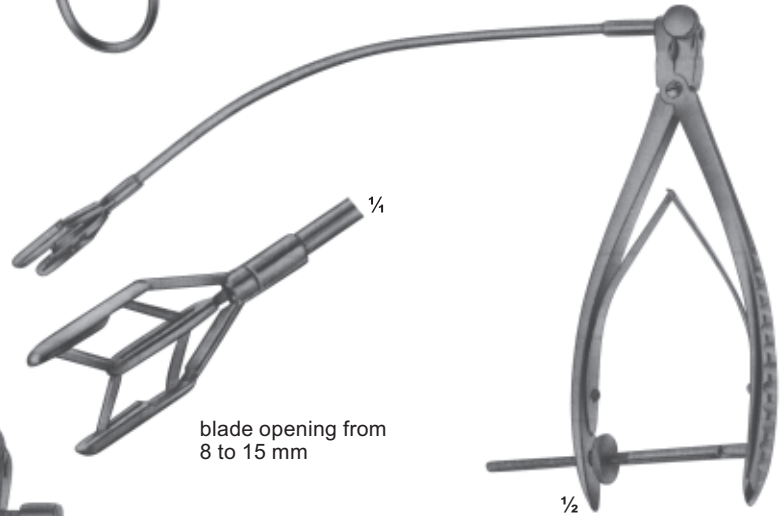

**05-7087
COOLEY**
Dilator for
mitral valve
for children

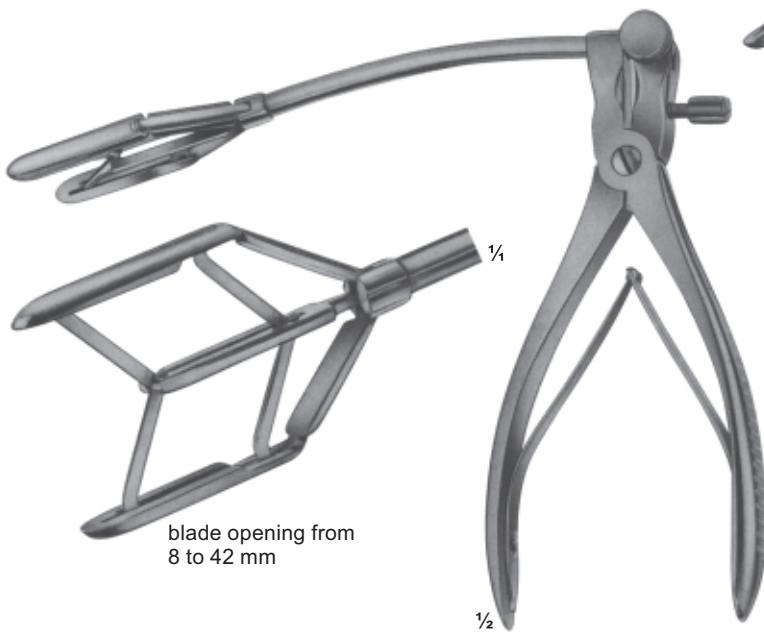

**05-7086
TUBBS**
Dilator for
mitral valve

JENKER Instrument Set For Tunnelling And Pulling-Through Vascular Grafts Toothings

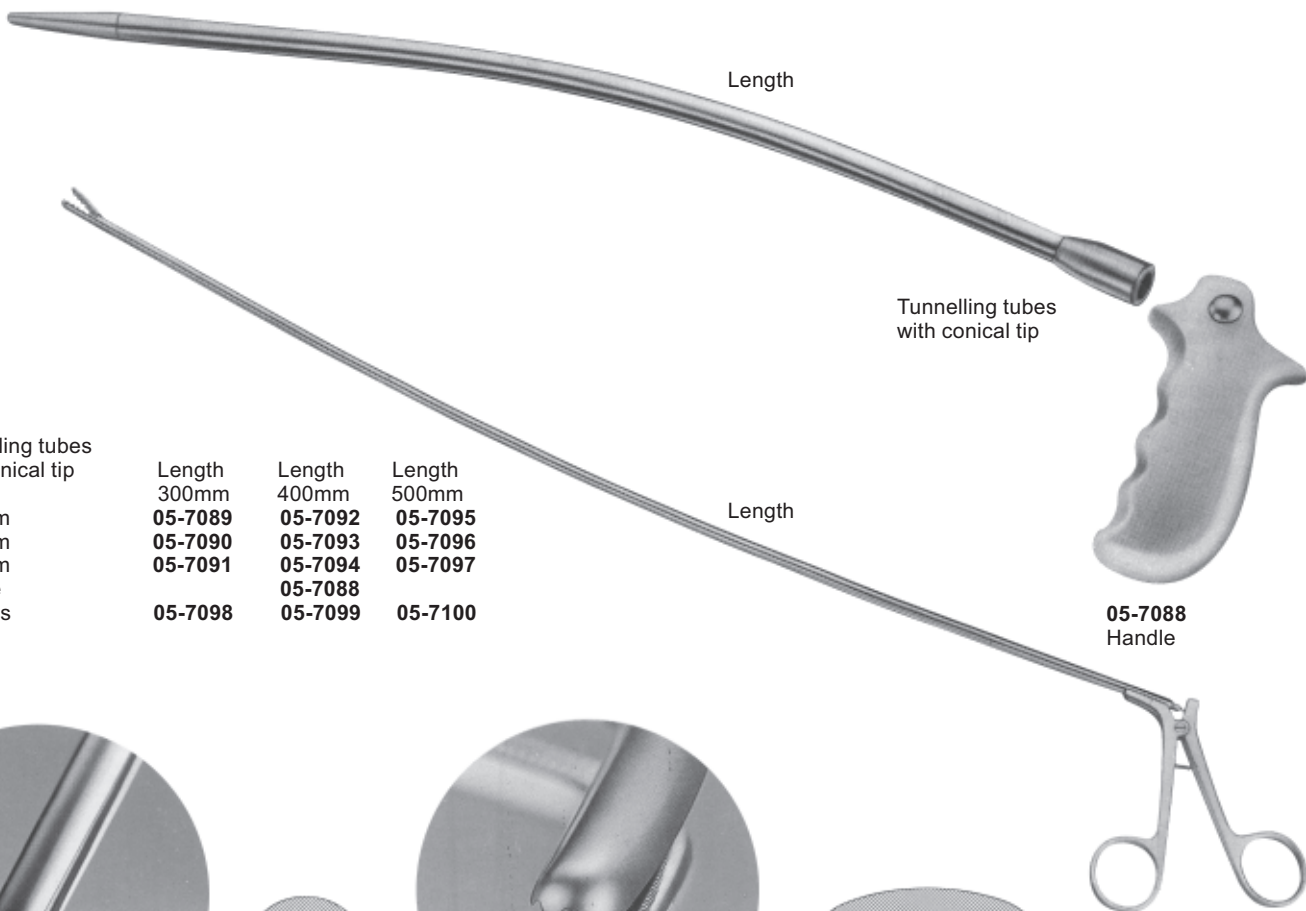

Tunnelling tubes with conical tip

	Length 300mm	Length 400mm	Length 500mm
∅ 12mm	05-7089	05-7092	05-7095
∅ 14mm	05-7090	05-7093	05-7096
∅ 17mm	05-7091	05-7094	05-7097
Handle	05-7098	05-7088	05-7100

Tunnelling tubes with conical tip

05-7088
Handle

05-7098
Forceps

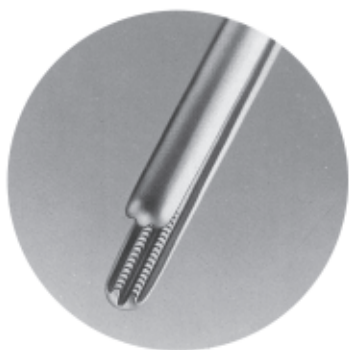

DE BAKEY
05-7101
1 : 2 rows of teeth

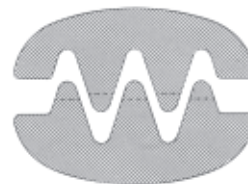
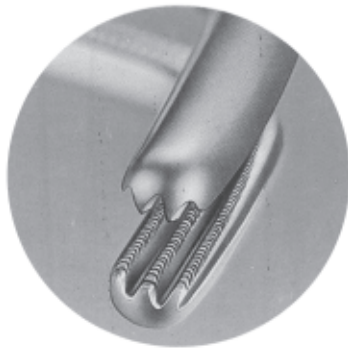

DE BAKEY
05-7102
2 : 3 rows of teeth

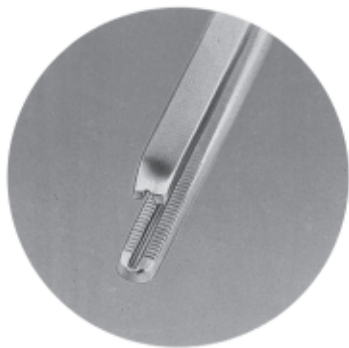

COOLEY
05-7103
2 : 2 rows of teeth

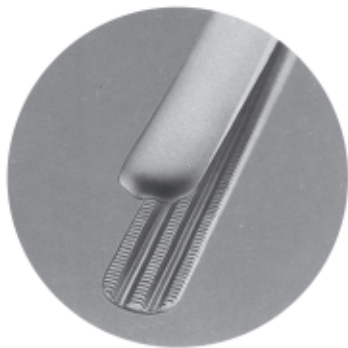

DARDIK
05-7104
2 : 3 rows of teeth

Atraumata Ultra-Light-Forceps

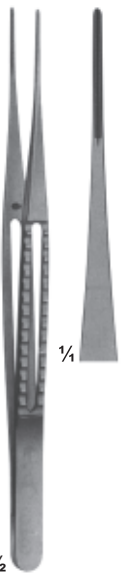

05-7105
Width of jaws 1.2 mm
Length 150mm

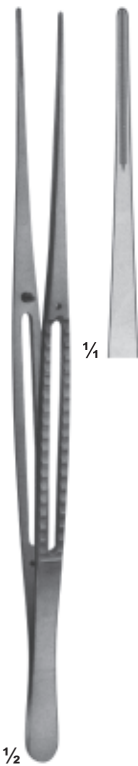

05-7106
Width 1,5 mm
Lenght 200 mm



05-7107
Width 1,5 mm
Lenght 240 mm



05-7108
Width 1,5 mm
Lenght 300 mm

Atraumata Dissecting Forceps

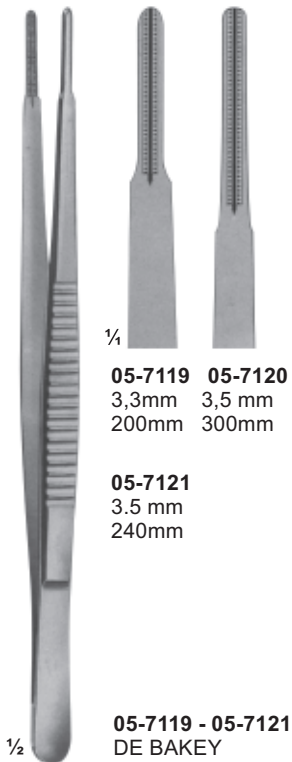
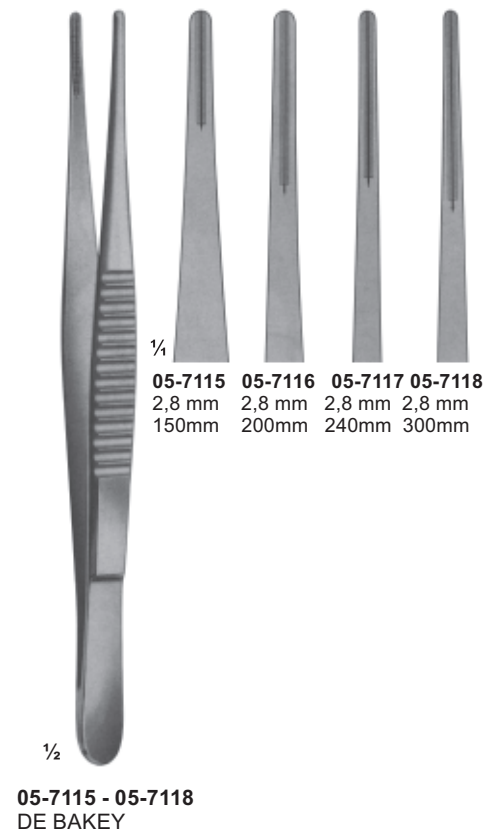
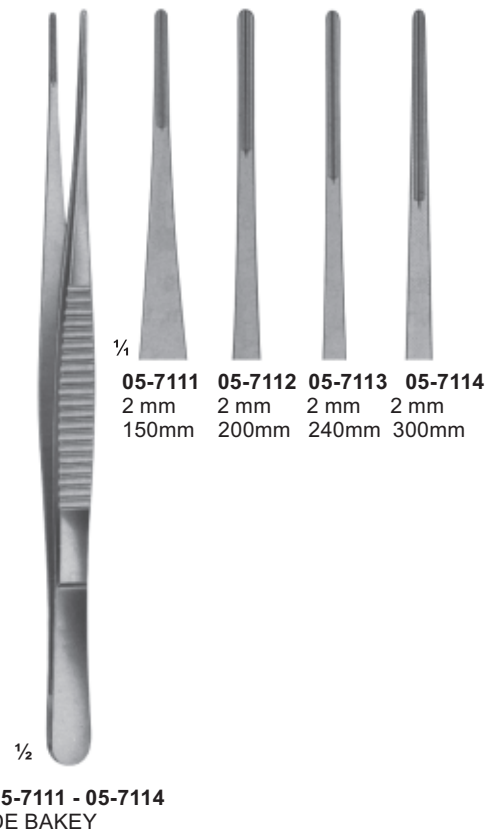
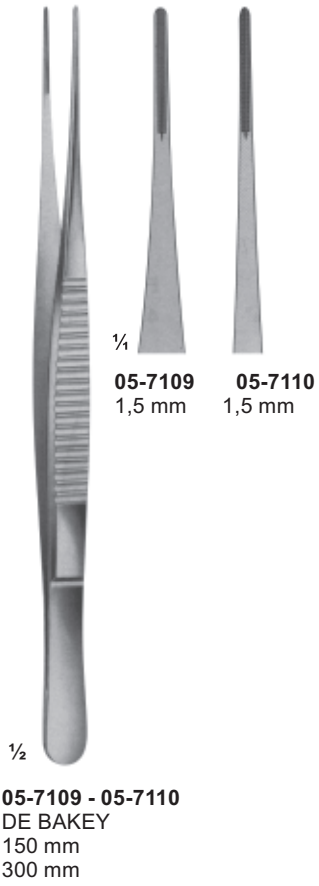

Atraumata Ring Handle Bulldog Clamps

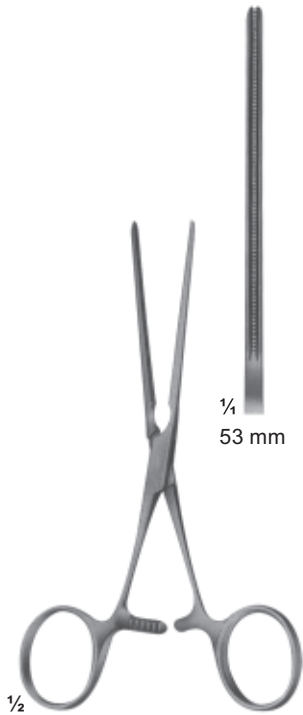

05-7124
DE-BAKEY
straight
130 mm

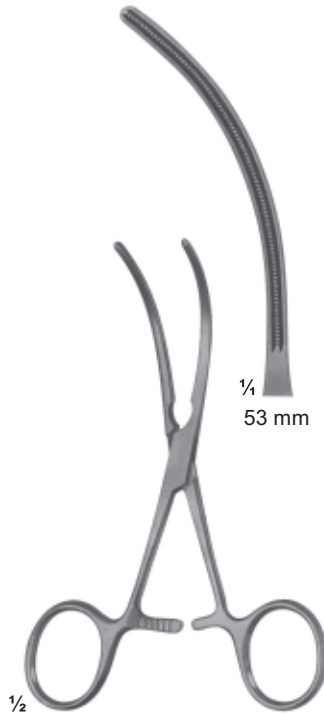

05-7125
DE-BAKEY
curved jaws
125 mm

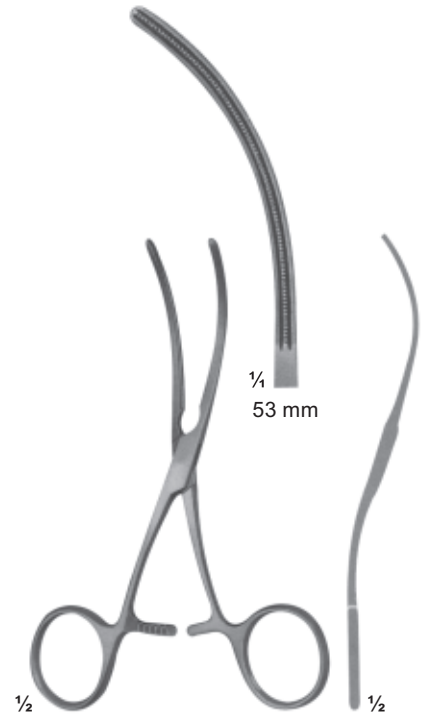

05-7126
DE-BAKEY
S-shaped curved
125 mm

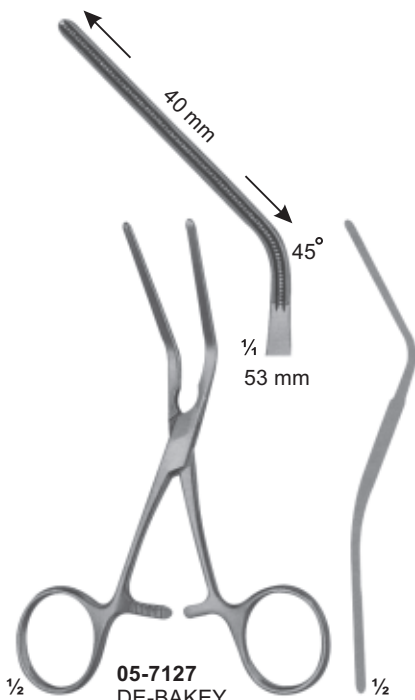

05-7127
DE-BAKEY
angled 45
125 mm

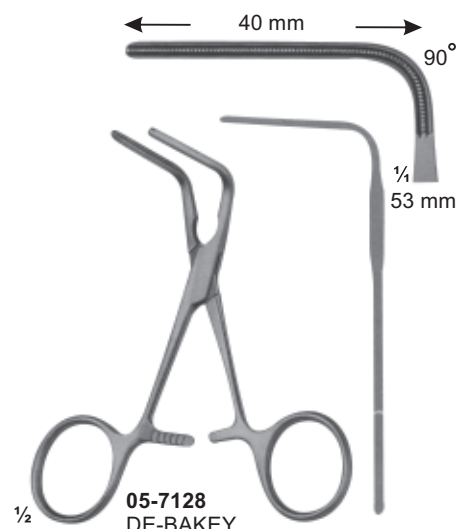

05-7128
DE-BAKEY
angled 90
105 mm

Atraumata Anastomosis and Multi-Purpose-Clamps for Neonatales

graduated



1/2

05-7129 - 05-7132
CASTANEDA



90°
1/4
48 mm
05-7129
Length 105 mm

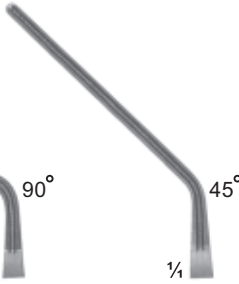

45°
1/4
48 mm
05-7130
Length 120 mm

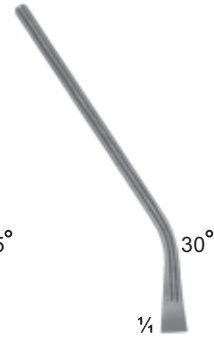

30°
1/4
48 mm
05-7131
Length 120 mm



1/4
48 mm
05-7132
Length 125 mm

graduated



1/2

05-7133 - 05-7136
CASTANEDA

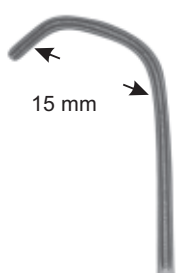

15 mm

1/4
48 mm
05-7133
Length 155 mm

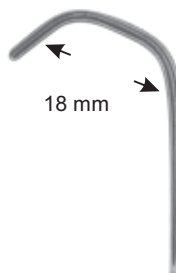

18 mm

1/4
52 mm
05-7134
Length 155 mm



23 mm

1/4
56 mm
05-7135
Length 155 mm

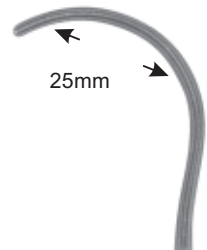

25mm

1/4
50 mm
05-7136
Length 155 mm

Atraumata Anastomosis-and Multi-Purpose Clamps-Pediatric types

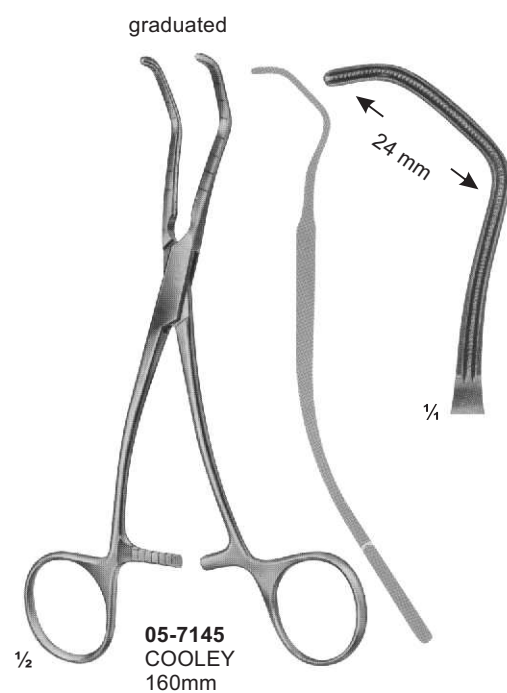
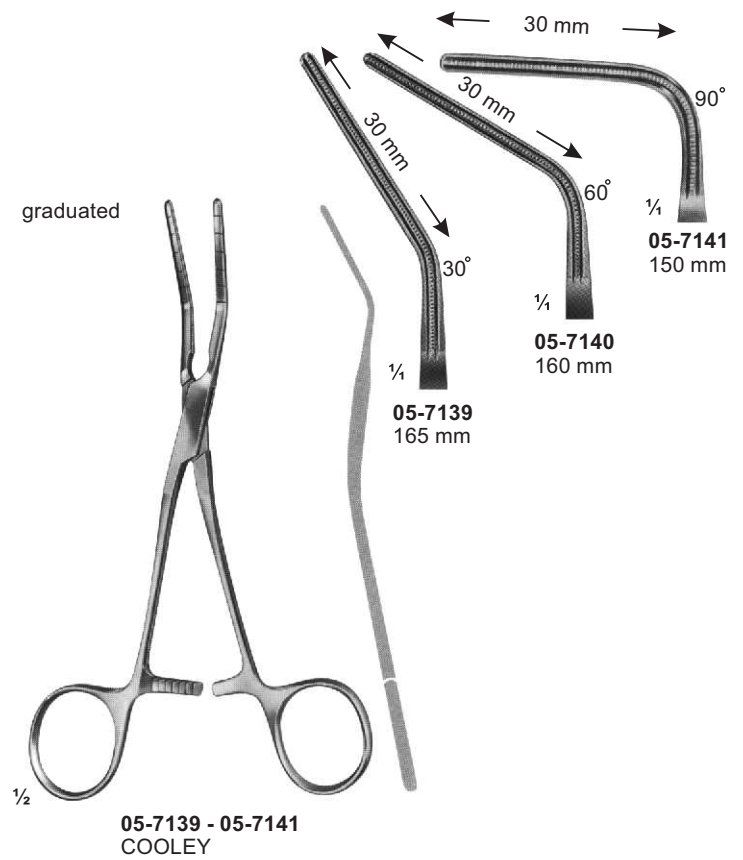
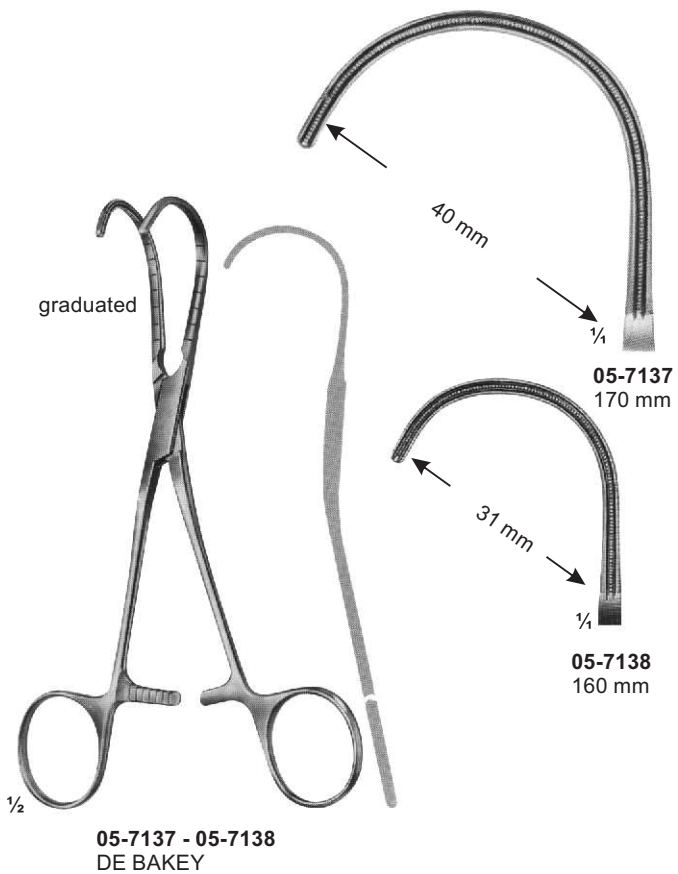

Atraumata Non-traumatic Haemostatic Forceps

Mosquito Forceps



05-7146 - 05-7147
125 mm

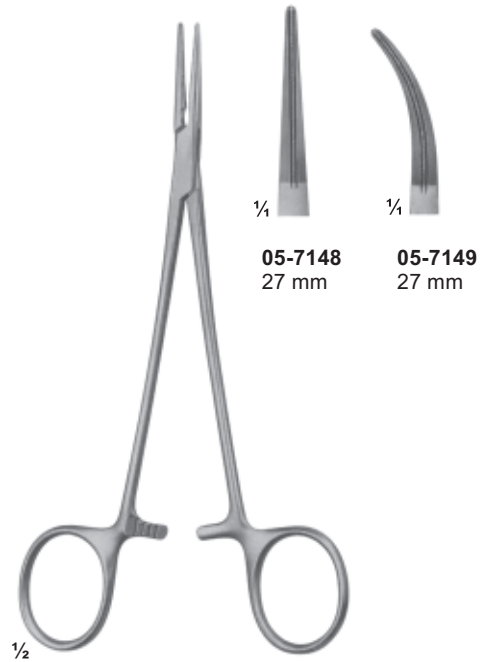

05-7148 - 05-7149
165 mm

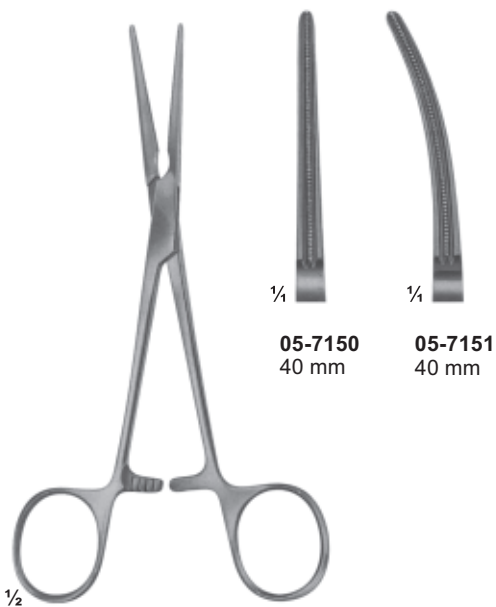

05-7150 - 05-7151
DE BAKEY-BAINBRIDGE
155 mm

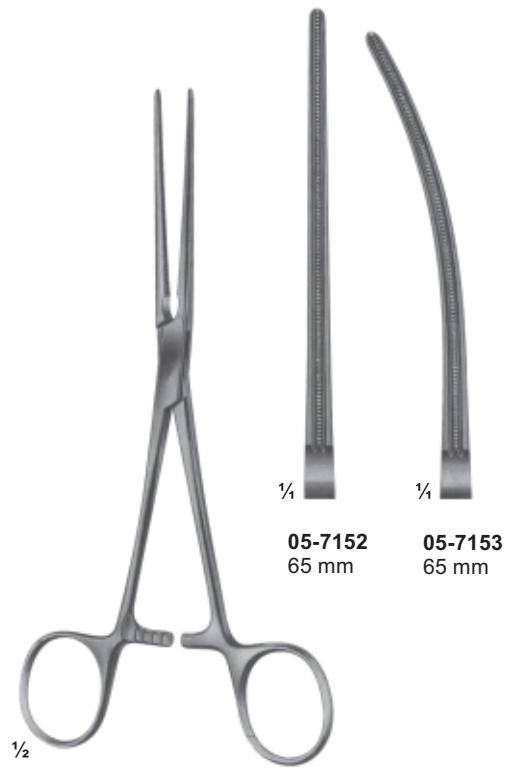

05-7152 - 05-7153
DE BAKEY-BAINBRIDGE
180 mm

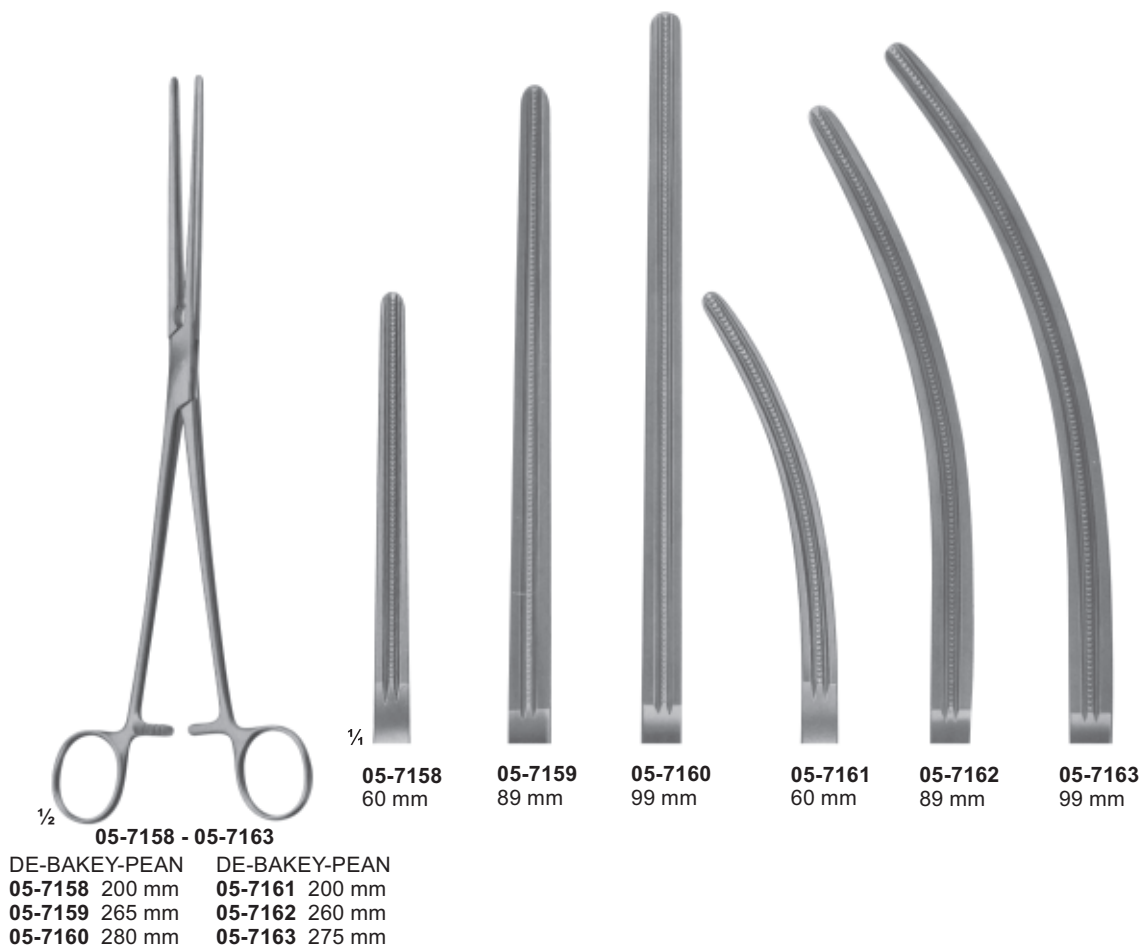

Atraumata Dissecting And Ligature Forceps Anastomosis Clamps

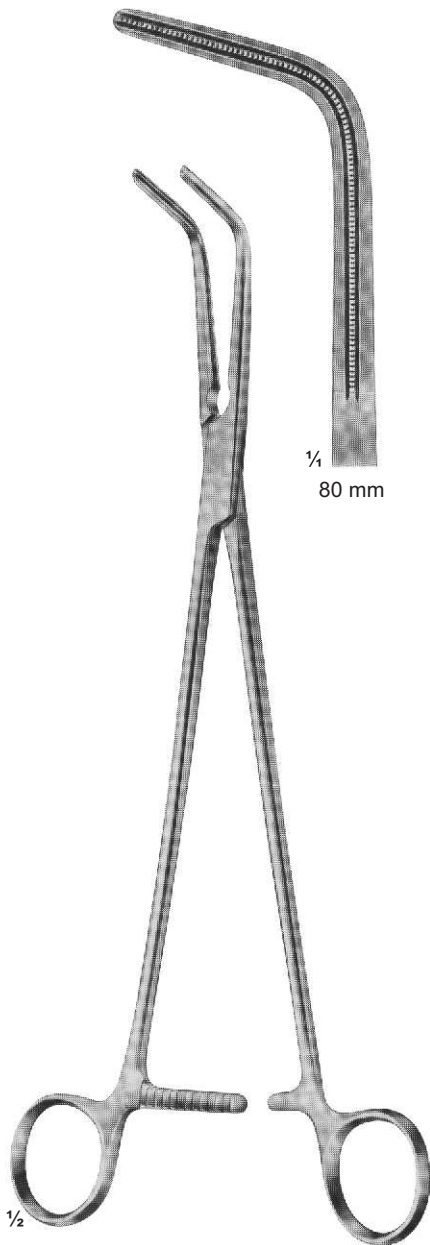

05-7164
DE-BAKEY-MIXTER
285 mm

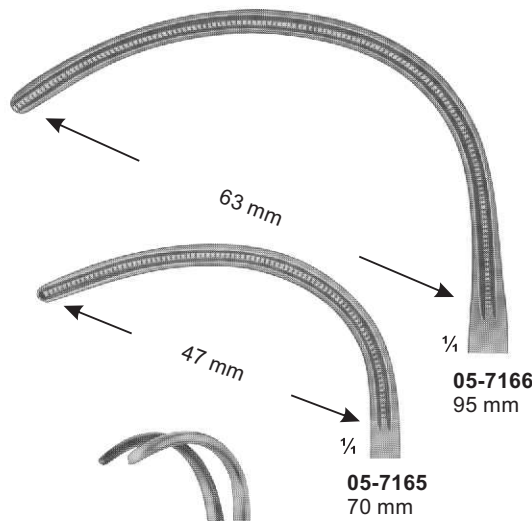

05-7165 - 05-7166
GLOVER
05-7165 195mm
05-7166 210mm

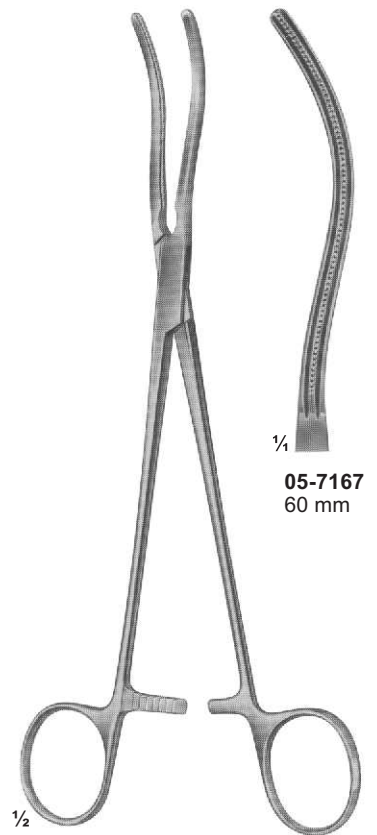

05-7167
GLOVER
220 mm

Atraumata Anastomosis, Vena-Cava Clamps

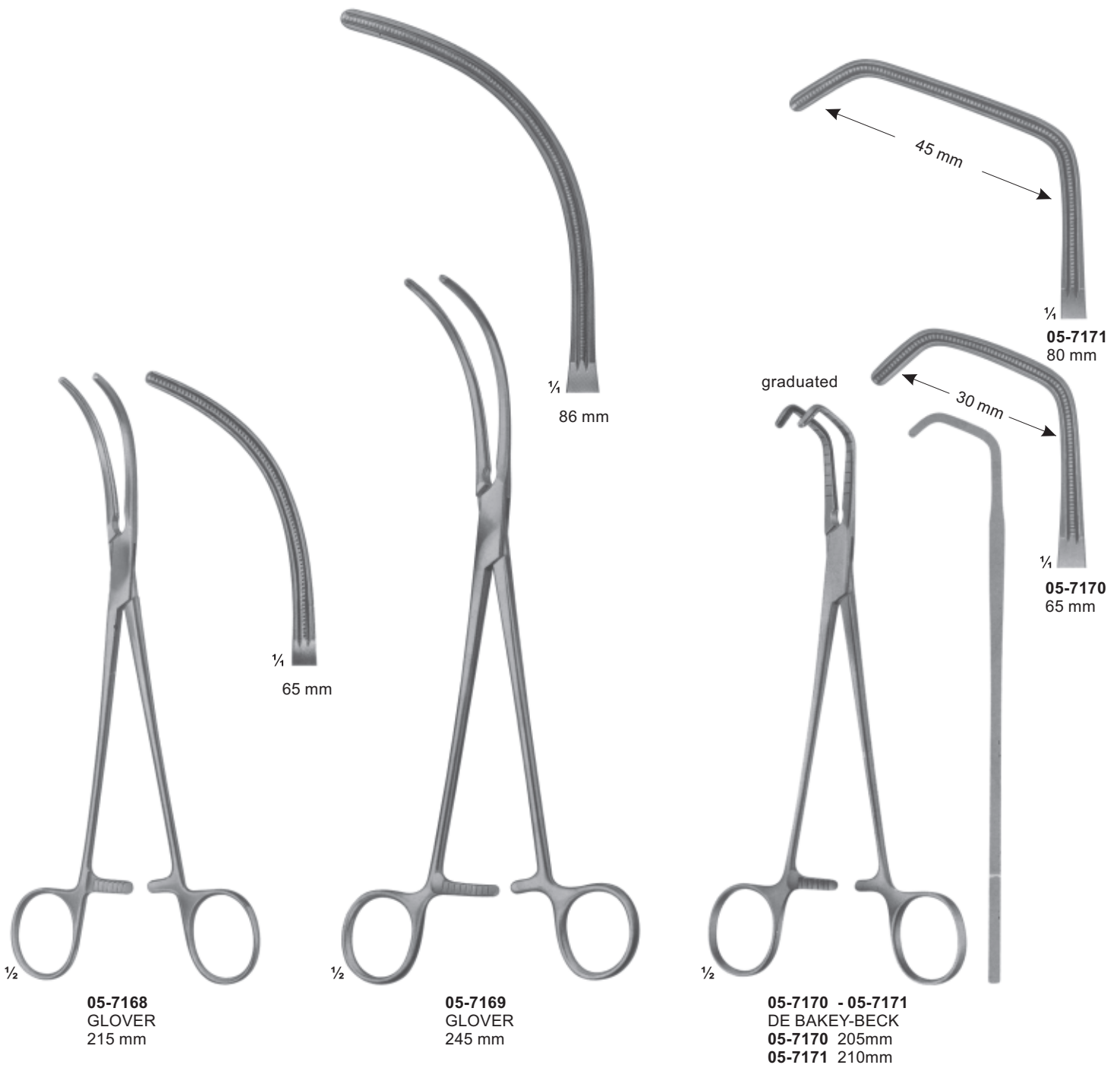

1/2
05-7168
 GLOVER
 215 mm

1/2
05-7169
 GLOVER
 245 mm

1/2
05-7170 - 05-7171
 DE BAKLEY-BECK
05-7170 205mm
05-7171 210mm

Atraumata Vena-Cava Clamps And Tangential Occlusion Clamps

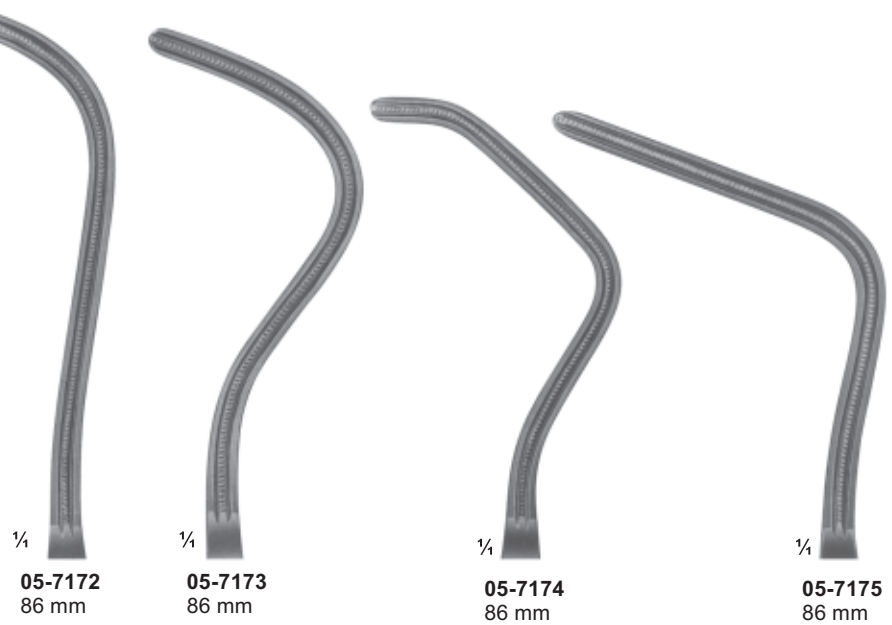

05-7172 - 05-7175
DE BAKEY-HARKEN
05-7172 - 255 mm
05-7173 - 245 mm
05-7174 - 245 mm
05-7175 - 245 mm



graduated

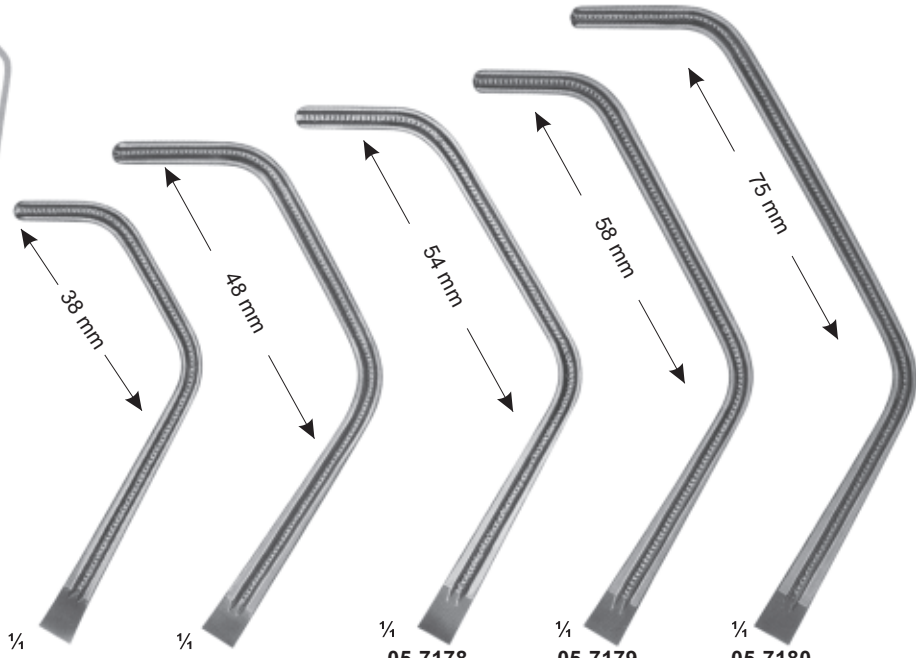

05-7176 - 05-7180
DE BAKEY

Total Length: 220 mm
Length of jaws: 85 mm

05-7176	05-7177	05-7178	05-7179	05-7180
265 mm	270 mm	270 mm	280 mm	
95 mm	99 mm	103 mm	119 mm	

Atraumata Tangential Occlusion And Coarctation Clamps



05-7181 - 05-7183
DE BAKEY-SATINSKY

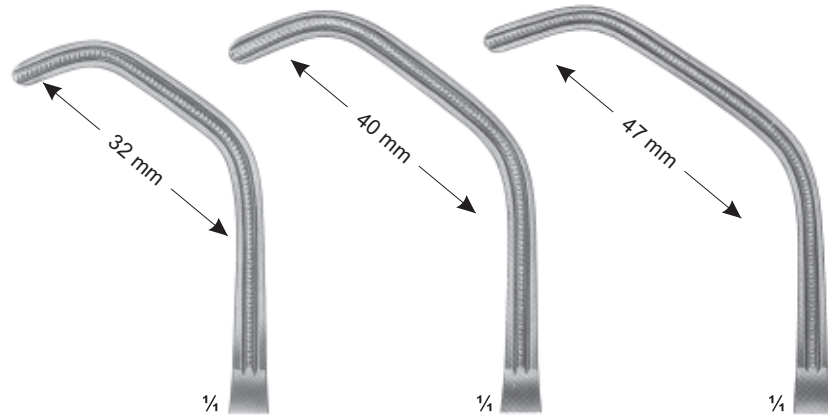

05-7181
68 mm
Length 235mm

05-7182
76 mm
Length 240mm

05-7183
84 mm
Length 245mm



05-7184 - 05-7185
DE BAKEY
05-7184 170mm
05-7185 165mm



05-7184
50 mm

05-7185
50 mm

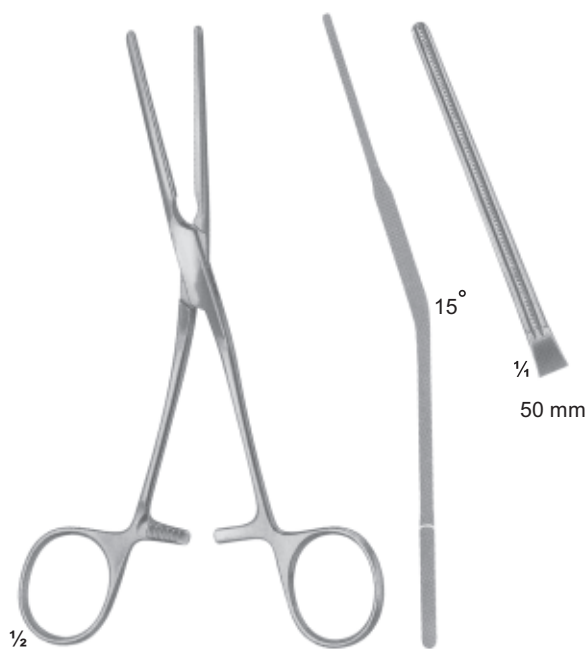

05-7186
DE BAKEY
165 mm

Atraumata Coarctation Clamps, Patent-Ducts Clamps

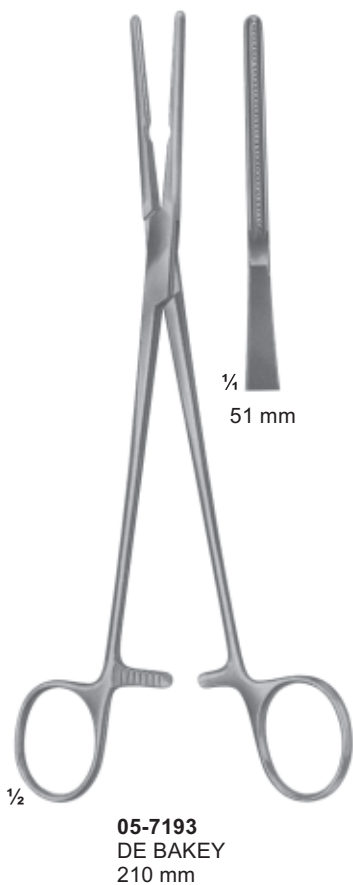
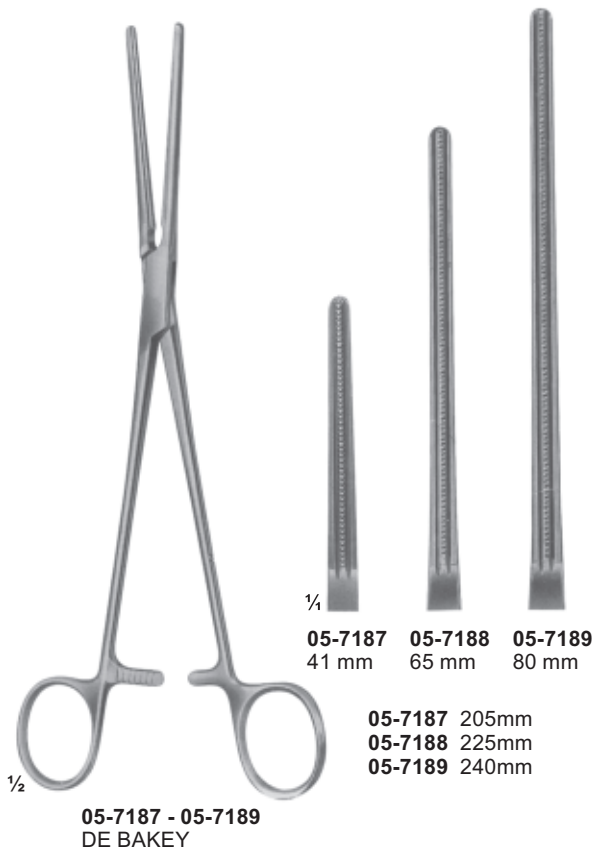

Atraumata Peripheral-Vascular Clamps

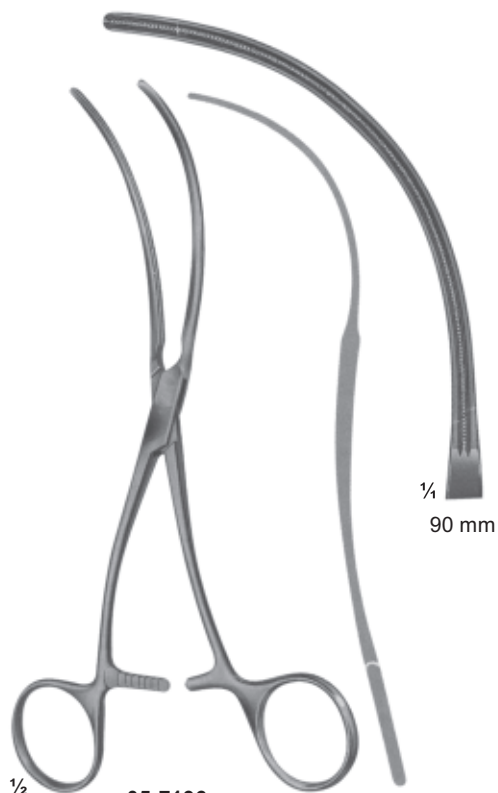

05-7196
DE BAKEY
190 mm

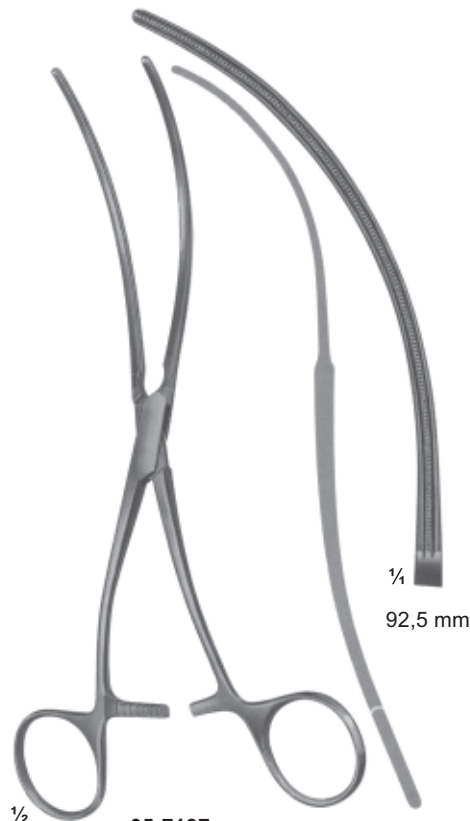

05-7197
DE BAKEY
200 mm

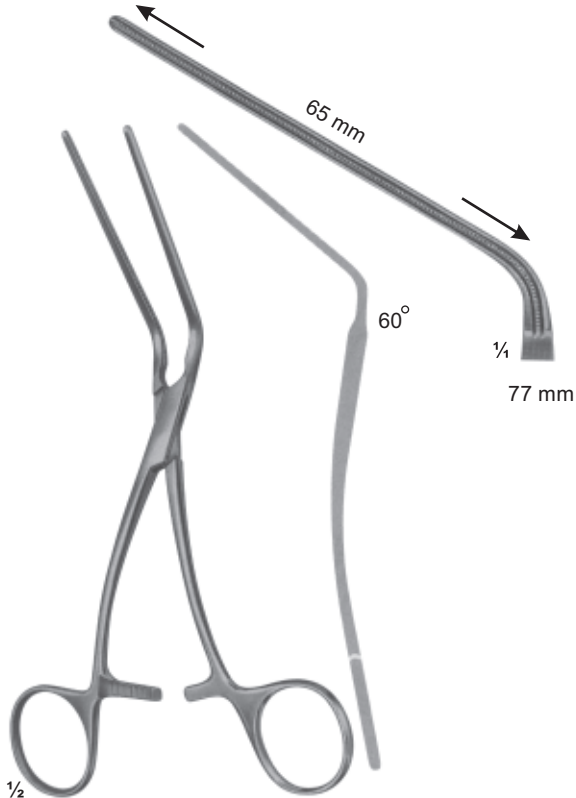

05-7198
DE BAKEY
180 mm

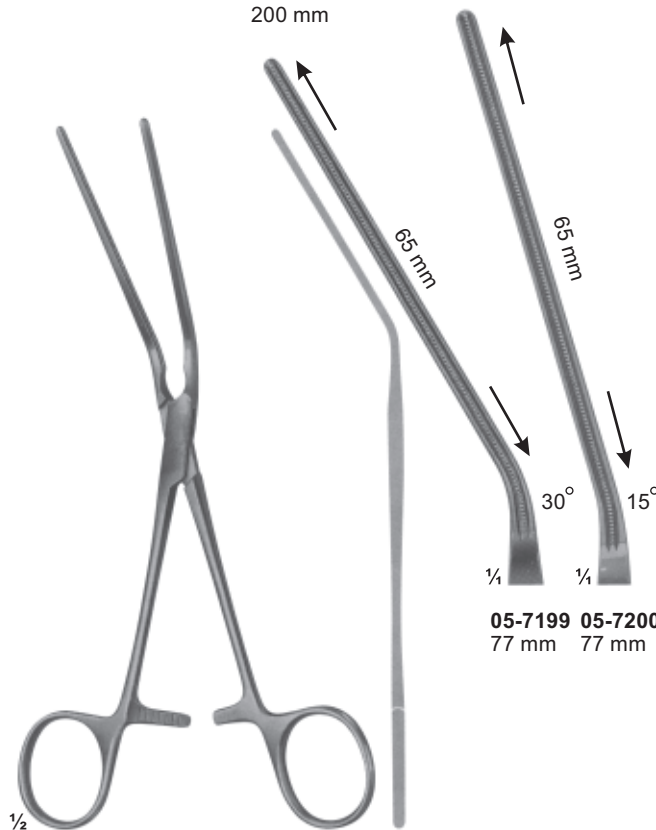

05-7199 - 05-7200
LELAND-JONES
190 mm

05-7199 05-7200
77 mm 77 mm

Atraumata Peripheral Vascular And Anastomosis Clamps



05-7201
LELAND-JONES
195 mm

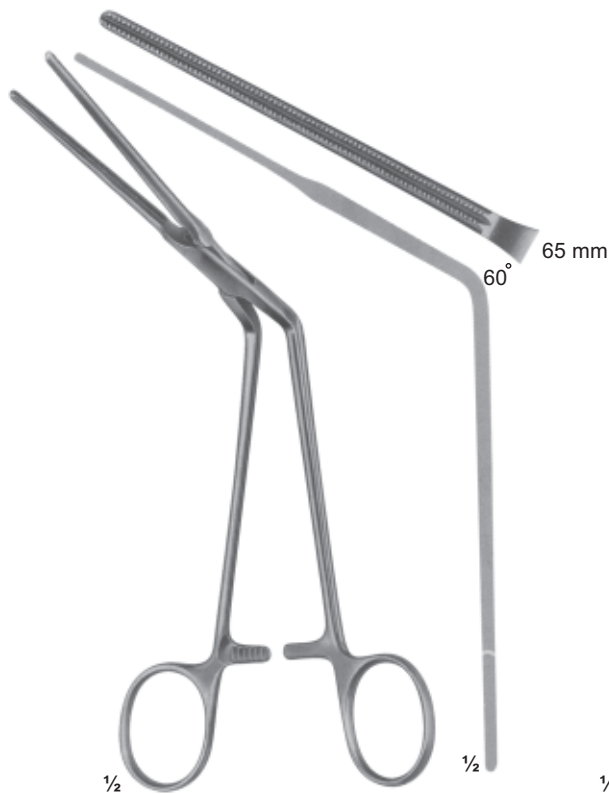

05-7202
DE BAKLEY
200 mm

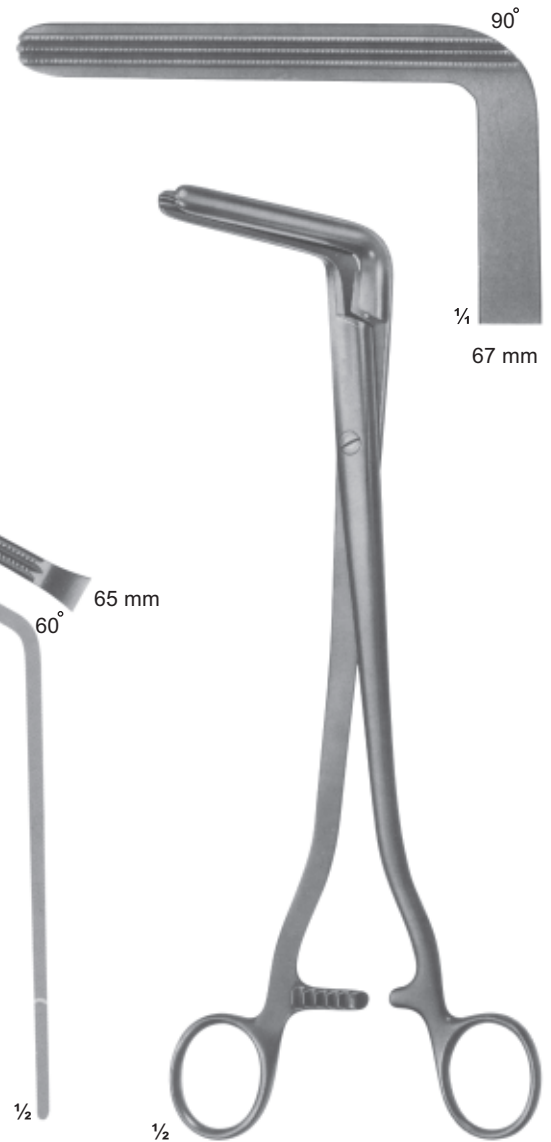

Iliac clamp

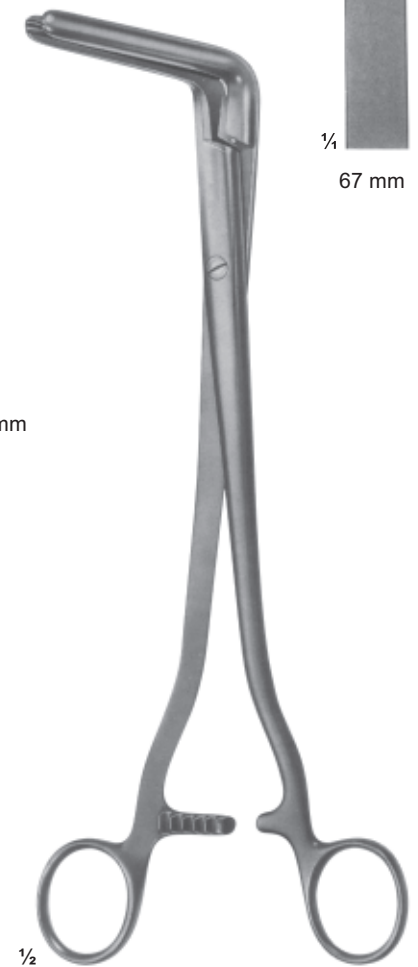

05-7203
WERTHEIM
250 mm

Atraumata Anastomosis And Ascending Aotra Cross Clamps

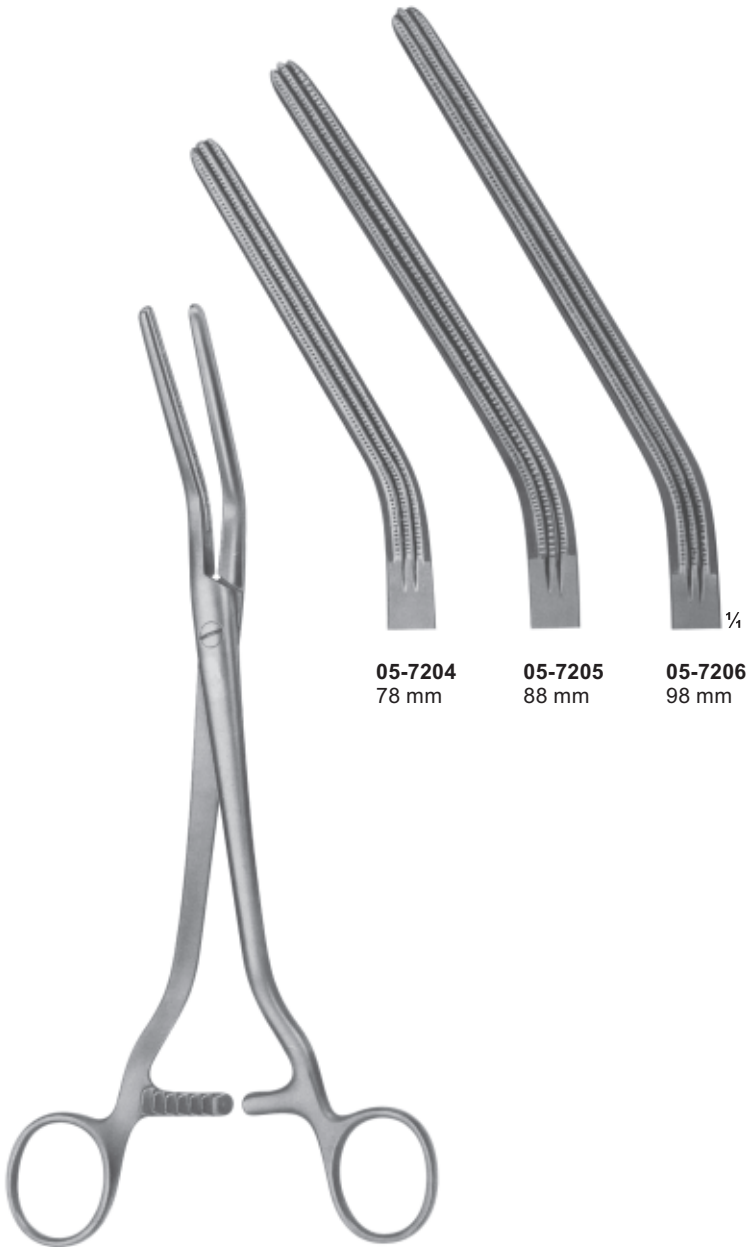

05-7204
78 mm

05-7205
88 mm

05-7206
98 mm

05-7204 - 05-7206
DICK
05-7204 255mm
05-7205 265mm
05-7206 275mm

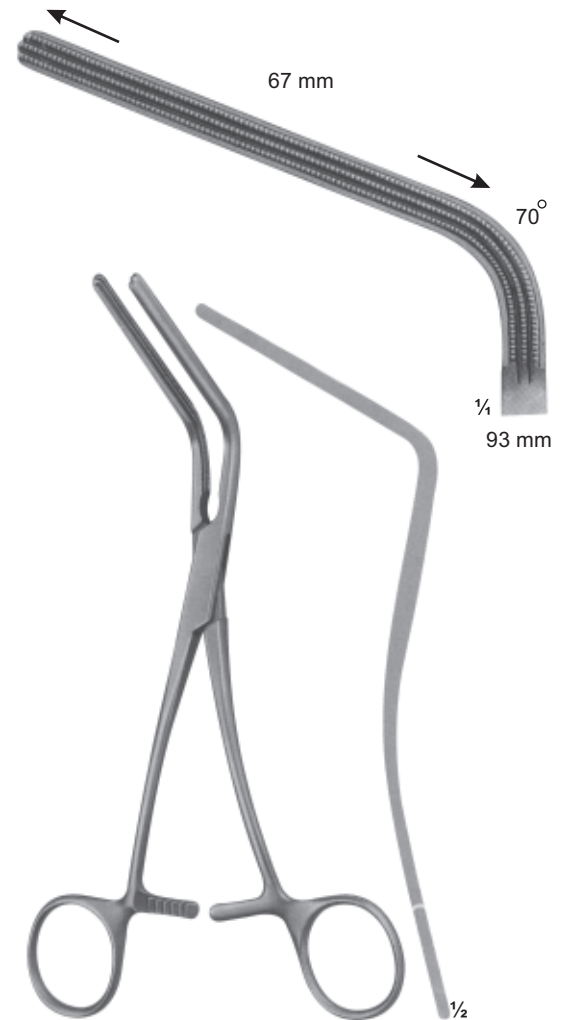

05-7207
MORRIS
175 mm

Atraumata Ascending Aorta Cross, Bronchus Clamps

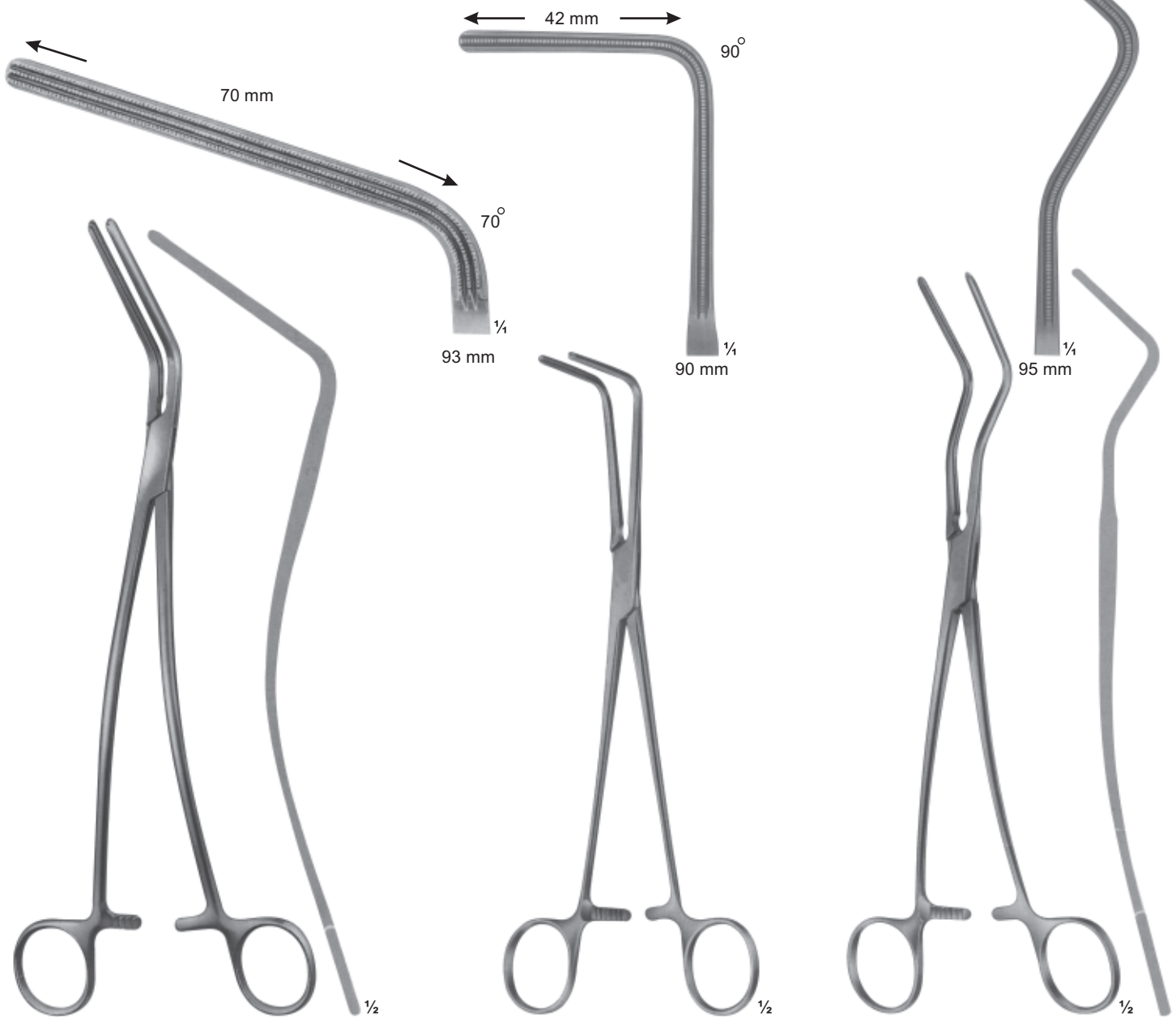

05-7208
DE BAKEY(Morris Modif)
240 mm

05-7209
LEES
220 mm

05-7210
LEES
245 mm

Atraumata Aorta-Aneurysm Clamps

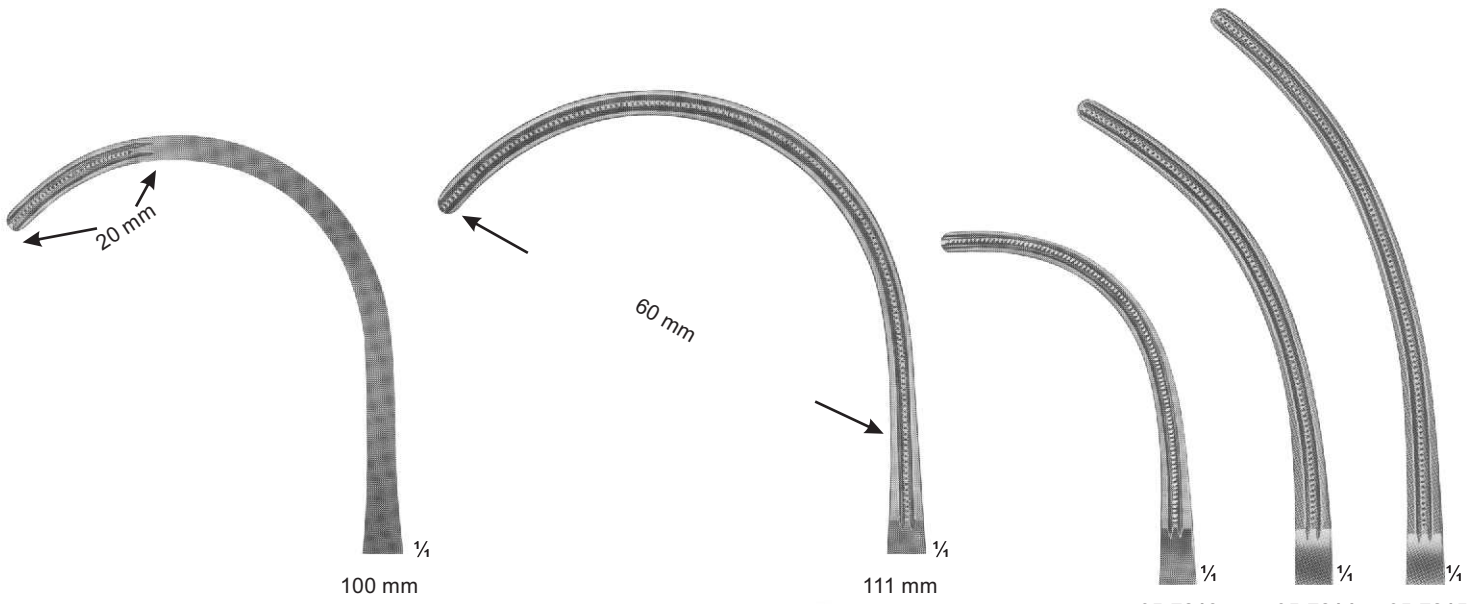

05-7213
70 mm

05-7214
75 mm

05-7215
85 mm

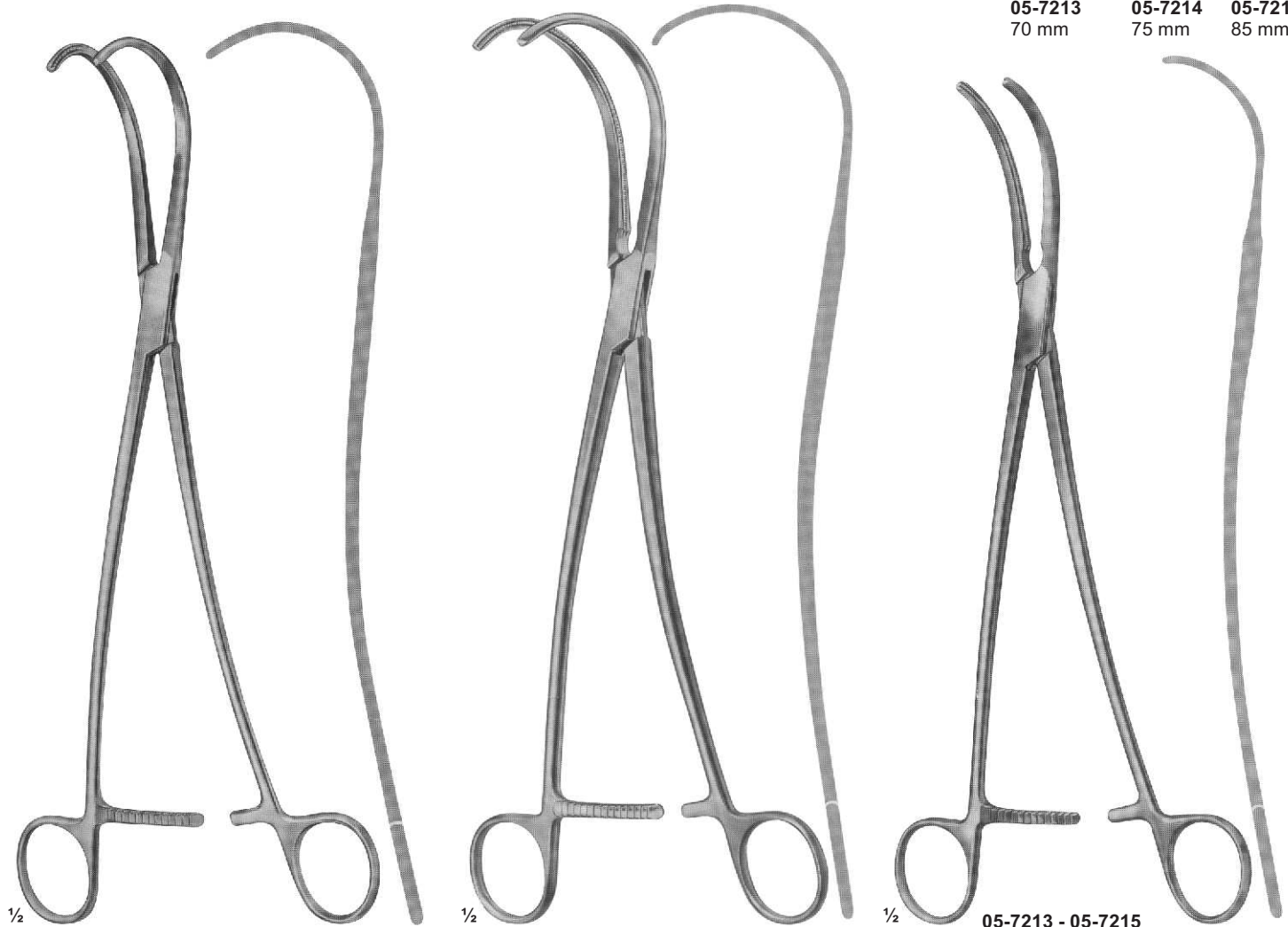

$\frac{1}{2}$
05-7211
DE BAKEY(Semb modif)
265 mm

$\frac{1}{2}$
05-7212
DE BAKEY
270 mm

$\frac{1}{2}$
05-7213 - 05-7215
DE BAKEY
05-7213 255mm
05-7214 265mm
05-7215 280mm

Atraumata Aorta-Aneurysm Clamps



2.3 Teeth Rows



05-7216 05-7217 05-7218 05-7219
95 mm 110 mm 130 mm 140 mm

05-7216 - 05-7219
DE BAKY
05-7216 250mm
05-7217 300mm
07-7218 315mm
07-7219 330mm



115 mm

05-7220
DE BAKY
300 mm

Atraumata Aorta Clamps

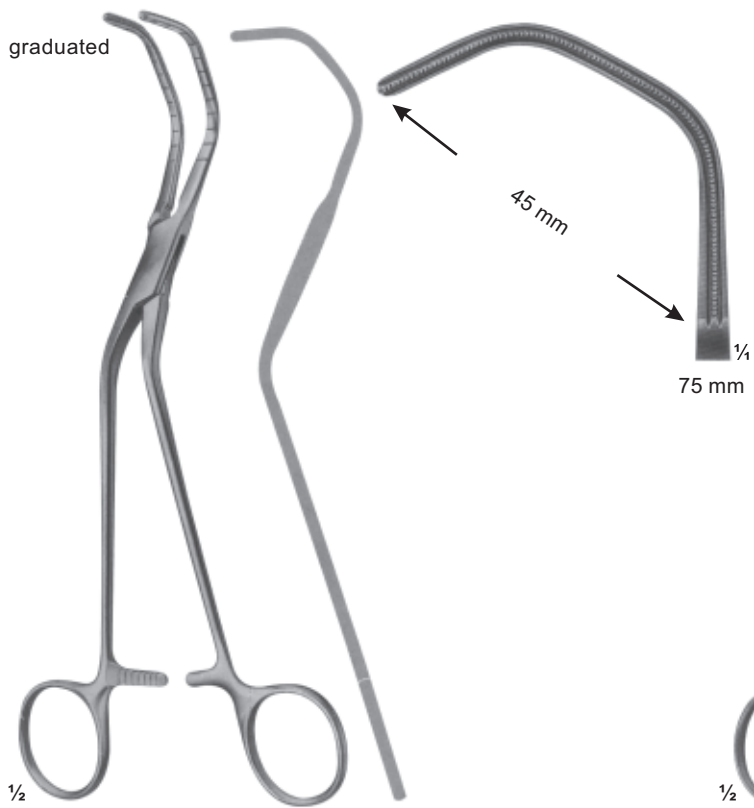

05-7221
DIETRICH
210 mm

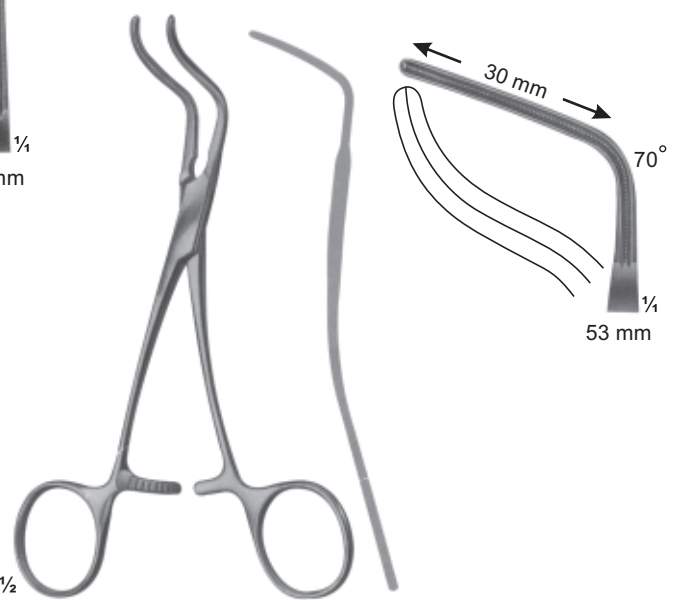

05-7222
SUBRAMANIAN(Modif)
155 mm

Atraumata Aorta Clamps

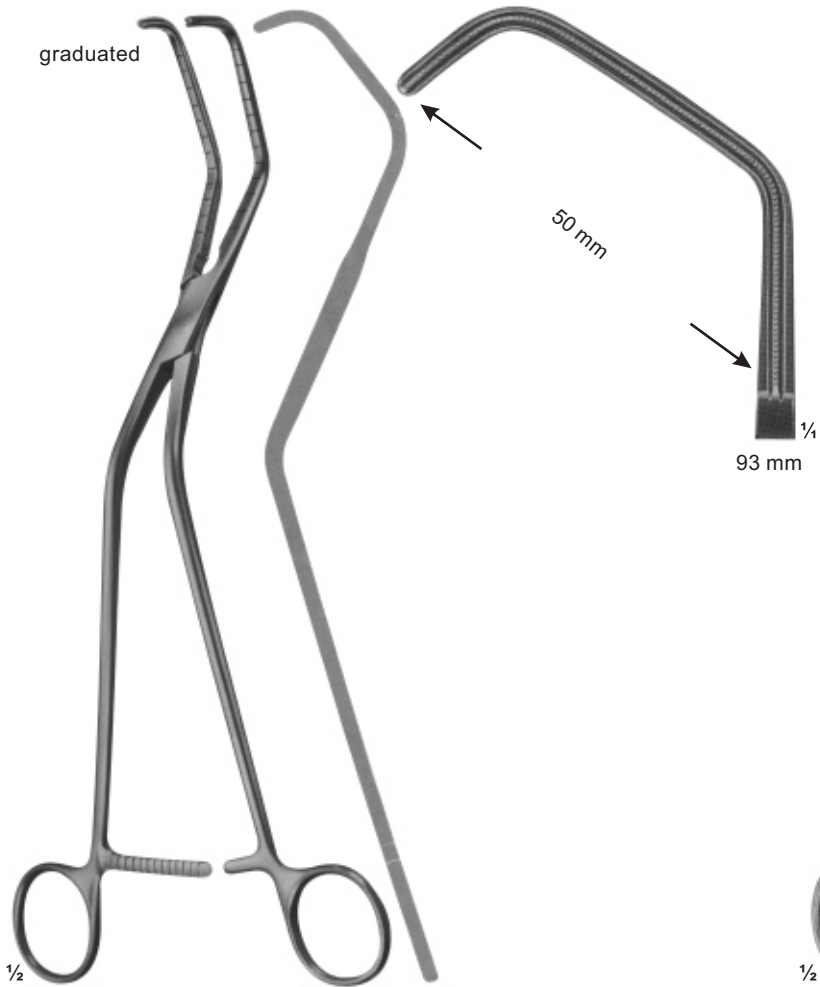

05-7223
OCHSNER
260 mm

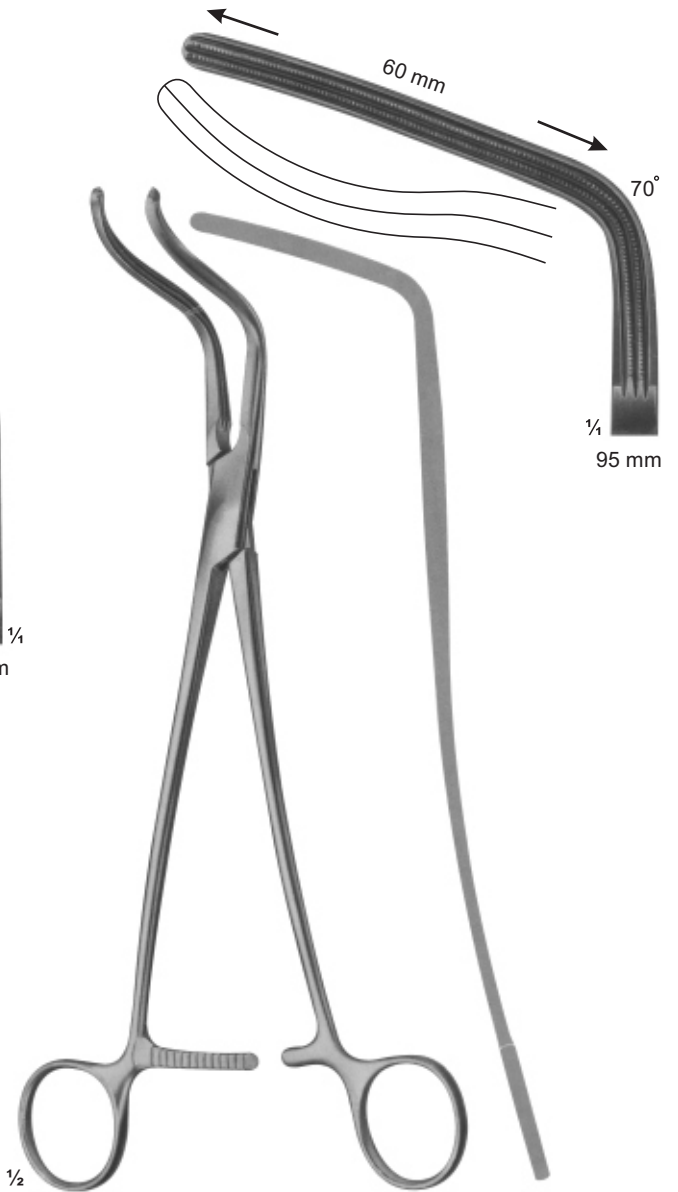

05-7224
DE BAKAY
265 mm

Atraumata Aorta-Anastomosis Clamps



L
05-7225
WEBER
260 mm

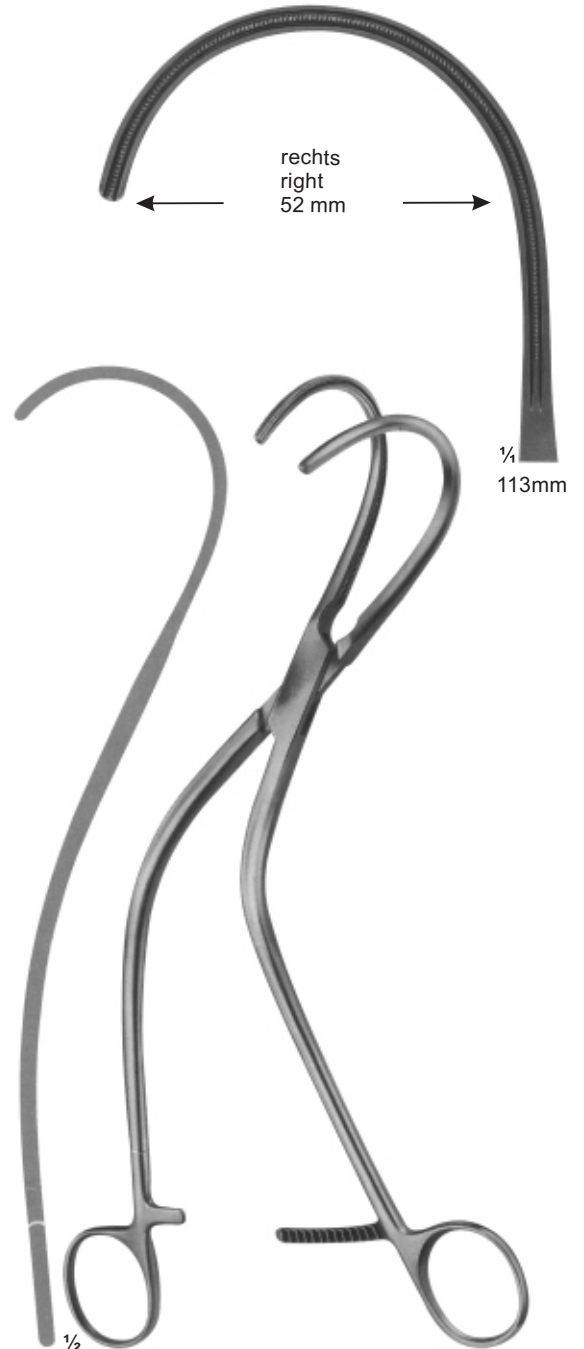

R
05-7226
WEBER
260 mm

Multi-Purpose Clamps



1/2 **05-7227 - 05-7230**
DE BAKEY

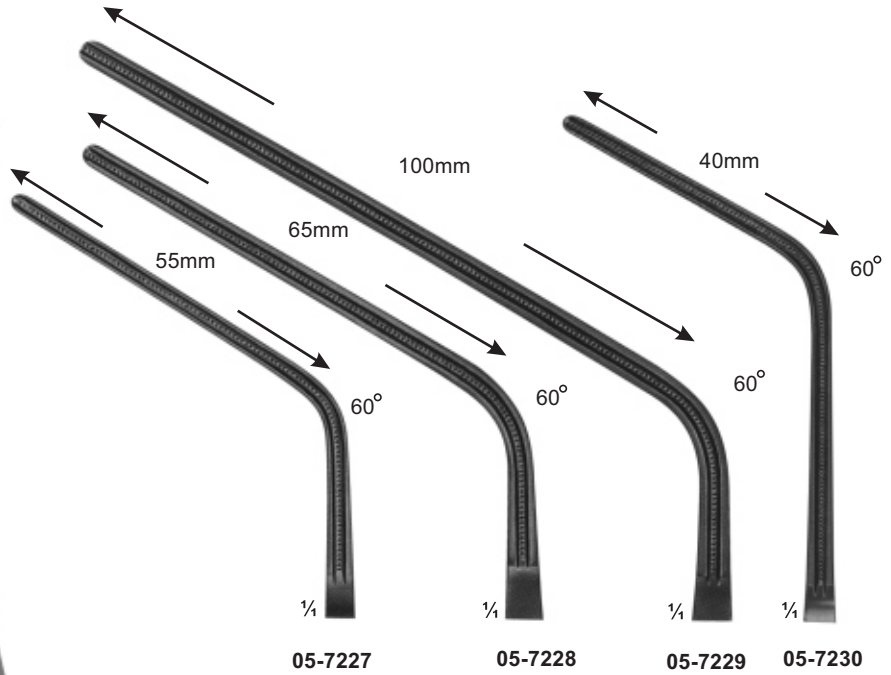

Total Length:	230 mm	280 mm	305 mm	240 mm
Length of jaws:	85 mm	100 mm	135 mm	93 mm

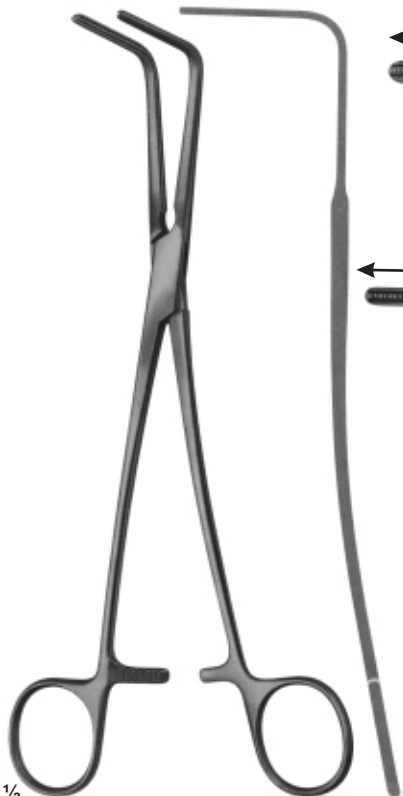

1/2 **05-7231 - 05-7234**
DE BAKEY

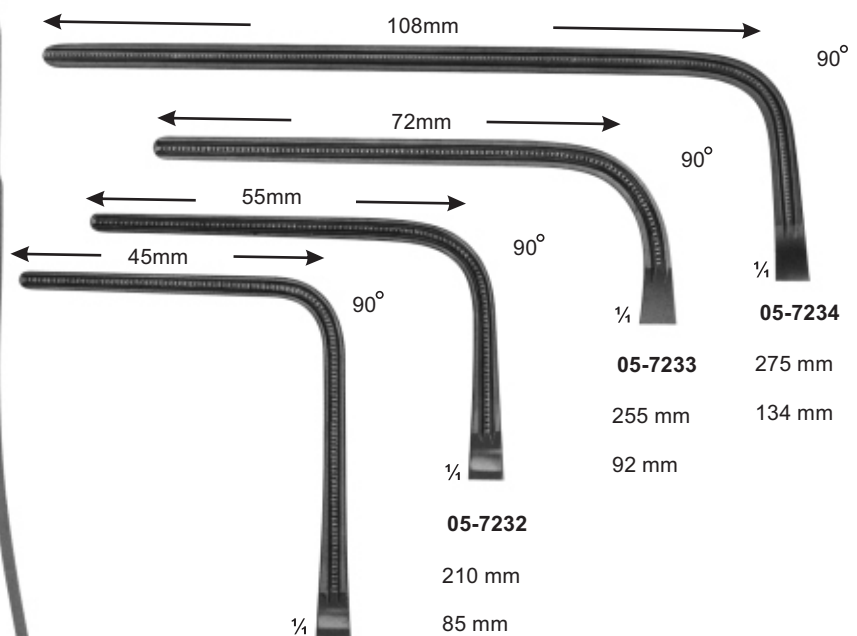

Total Length:	225 mm
Length of jaws:	93 mm

Ring Handle Bulldog Clamps Anastomosis Clamps, Pediatric Types

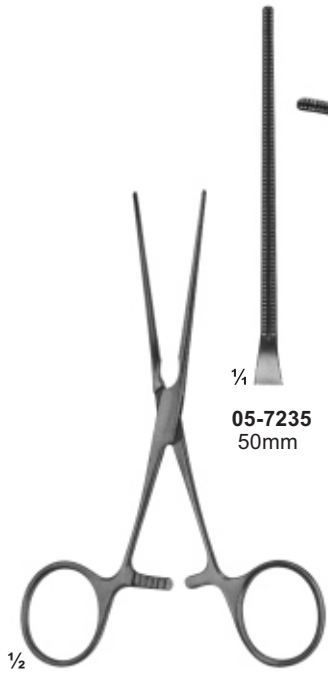

05-7235
50mm

05-7236
50mm

05-7235 - 05-7236
COOLEY
125 mm, 115 mm



05-7237
COOLEY
100 mm

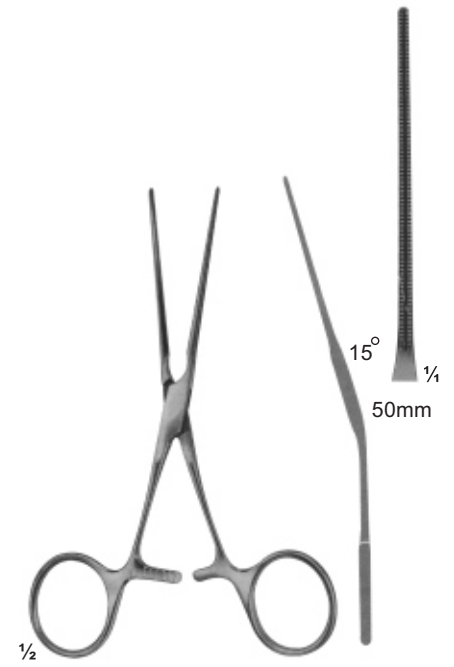

05-7238
COOLEY
125 mm

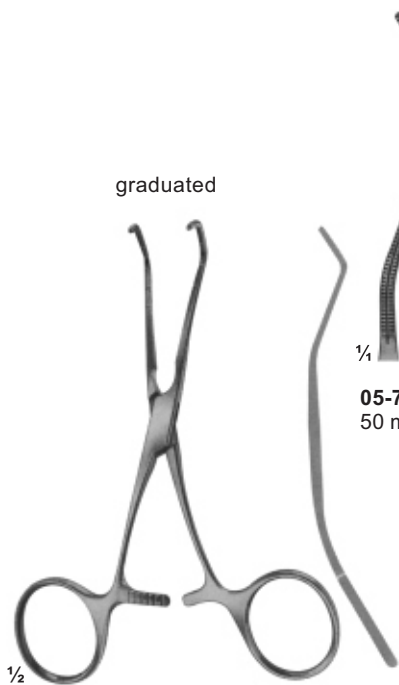

graduated

05-7239
50 mm

05-7239 - 05-7240
COOLEY
120 mm, 115 mm

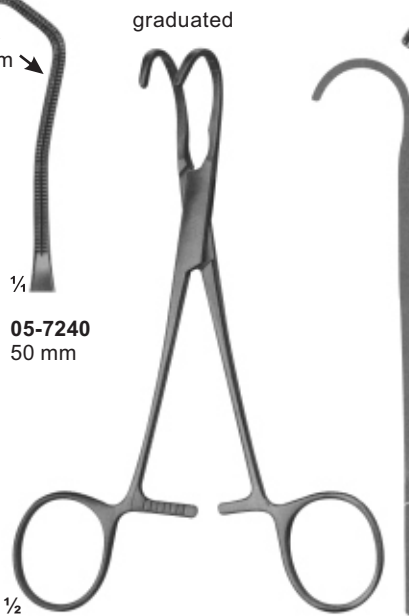

graduated

05-7240
50 mm

05-7241 - 05-7242
COOLEY-BECK
150 mm, 155 mm

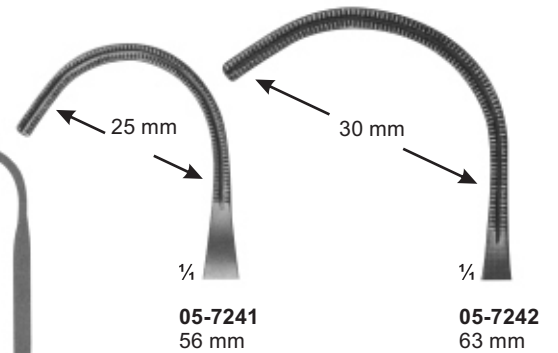

05-7241
56 mm

05-7242
63 mm

Anastomosis Clamps, Pediatric Types

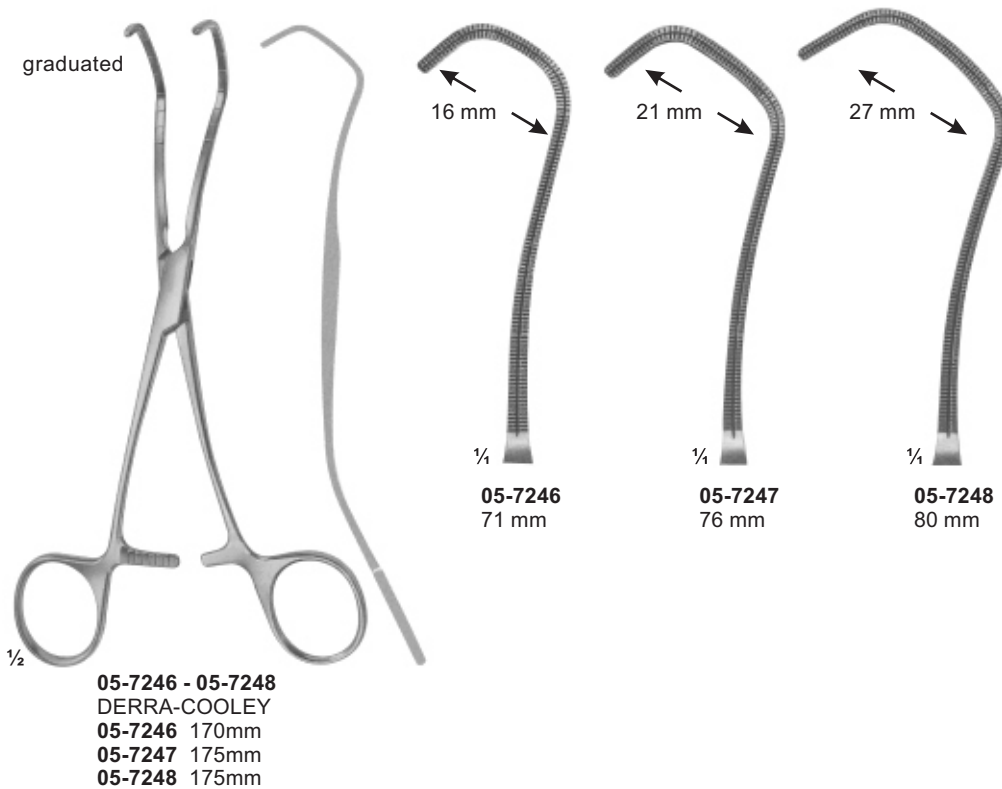
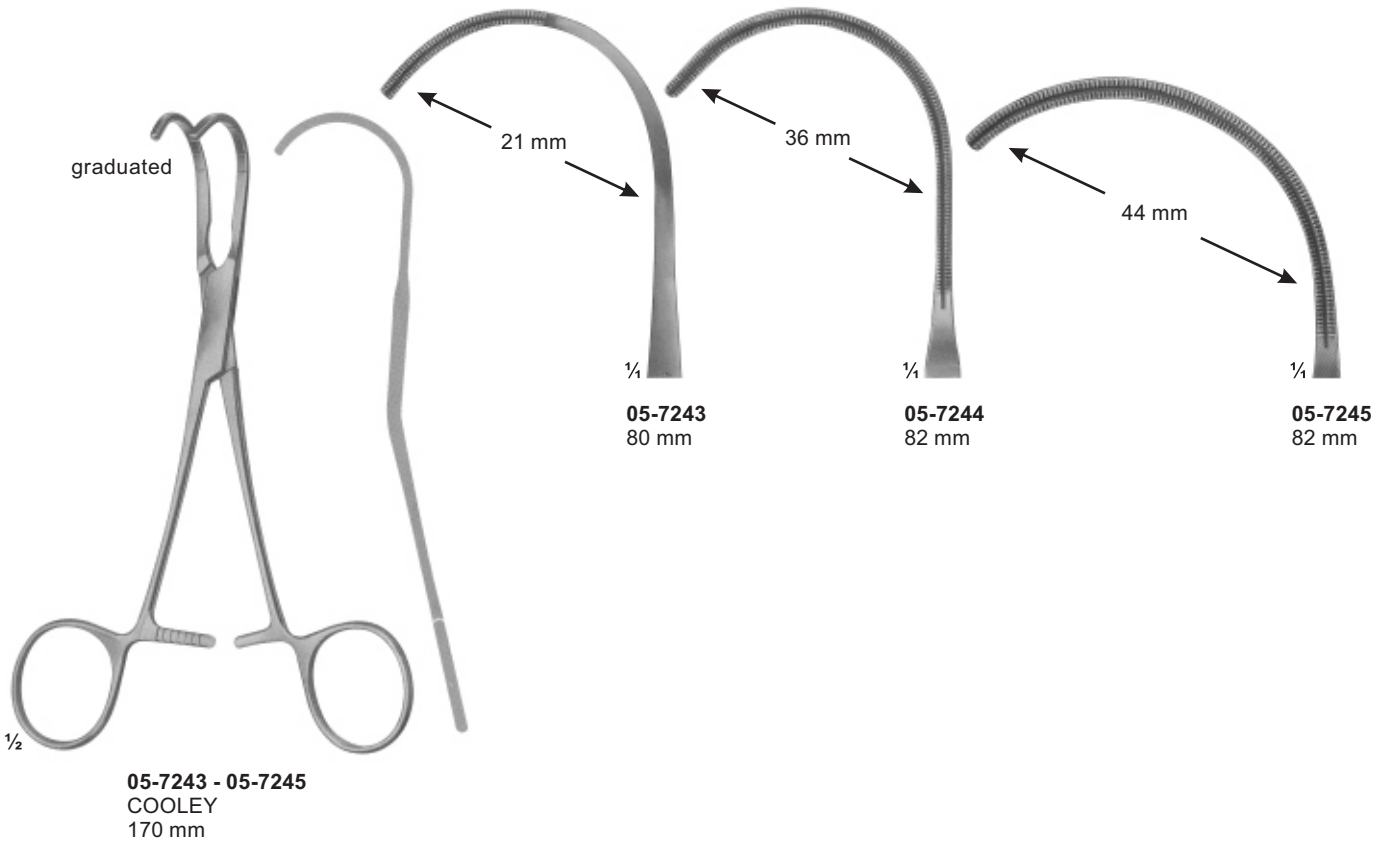

Anastomosis Clamps Multi-Purpose Clamps Pediatric Types

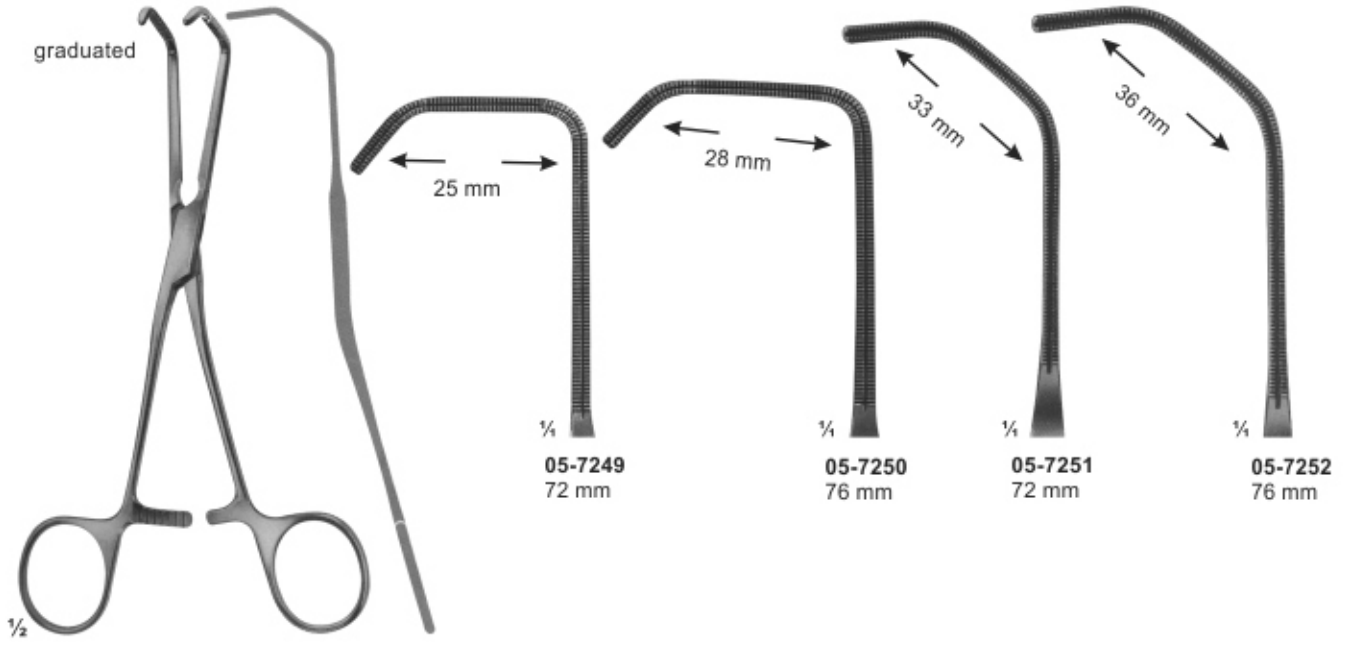

05-7249 - 05-7252
COOLEY
05-7249 165mm
05-7250 165mm
05-7251 175mm
05-7252 180mm

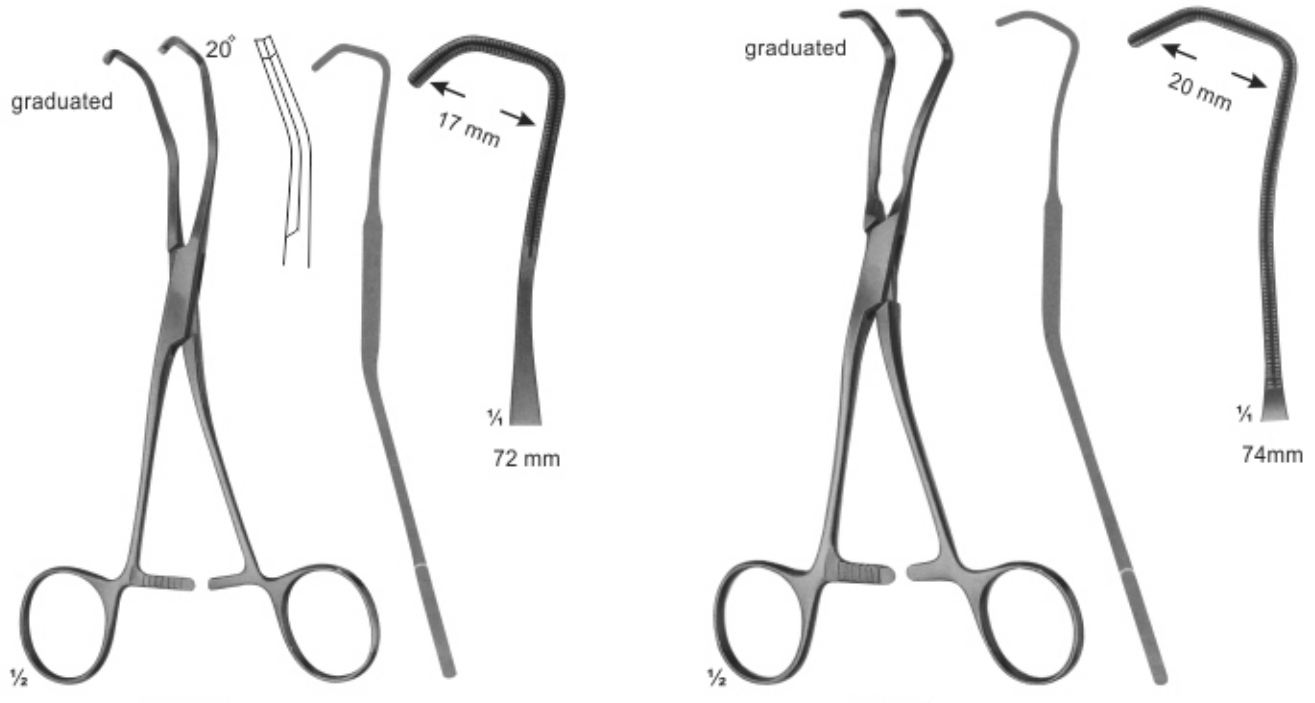

05-7253
COOLEY
170 mm

05-7254
COOLEY
175 mm

Multi-Purpose Clamps, Pediatric Types

graduated

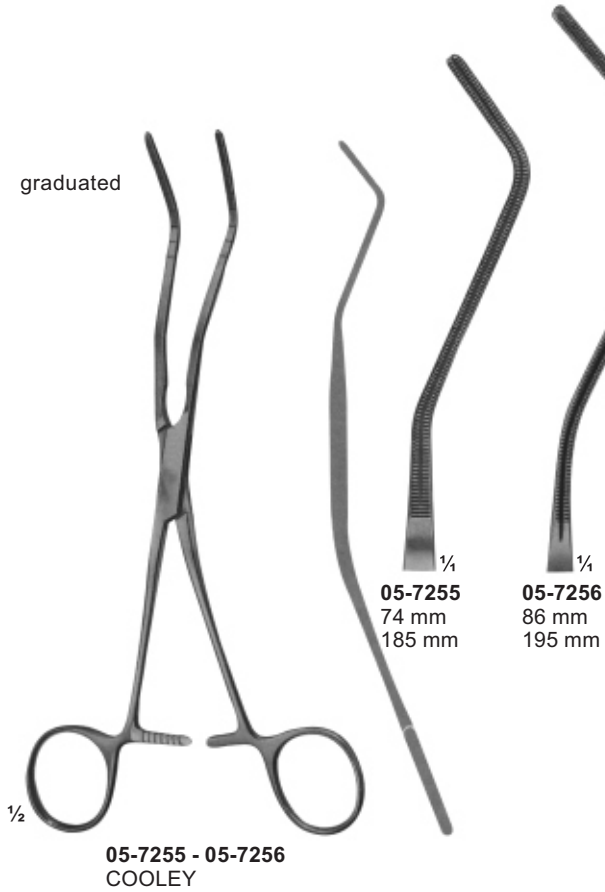

graduated



graduated

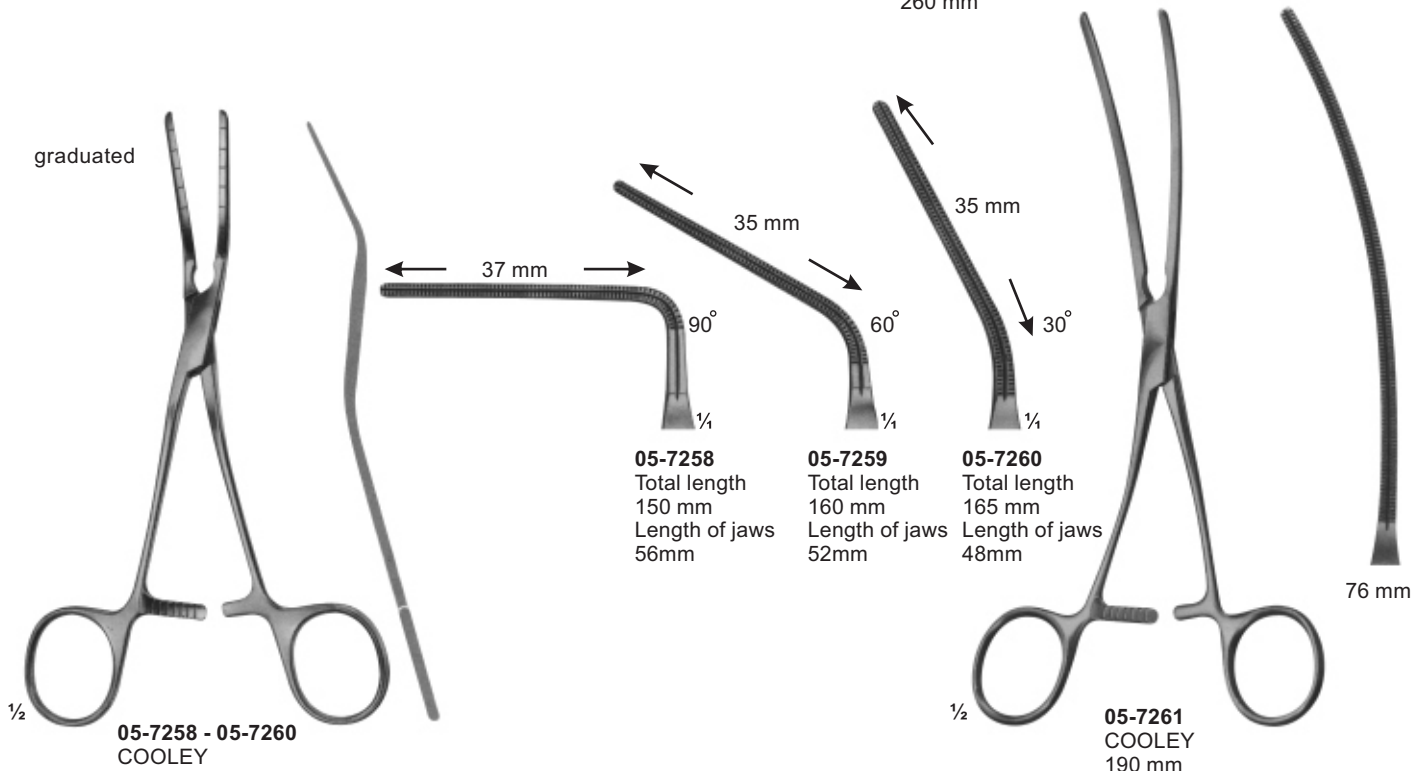

Atraumata Aorta Clamps, Patent-Ductus Clamps, Coarctation Clamps Pediatric Types

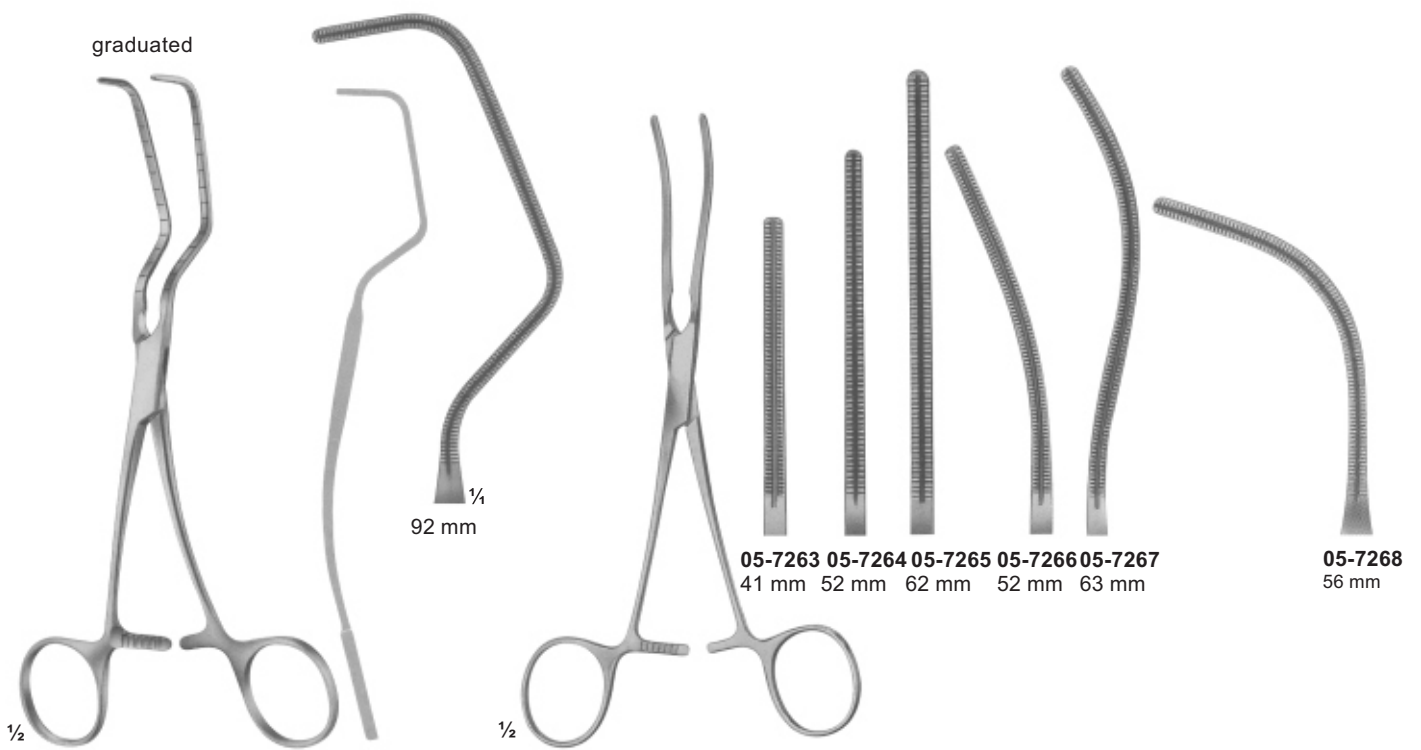

1/2
05-7262
PARRY-COOLEY
185 mm

1/4
92 mm

1/2
05-7263 - 05-7268
COOLEY
05-7263 160mm
05-7264 170mm
05-7265 180mm
05-7266 180mm
05-7267 180mm
05-7268 160mm

05-7263 41 mm 05-7264 52 mm 05-7265 62 mm 05-7266 52 mm 05-7267 63 mm

05-7268 56 mm

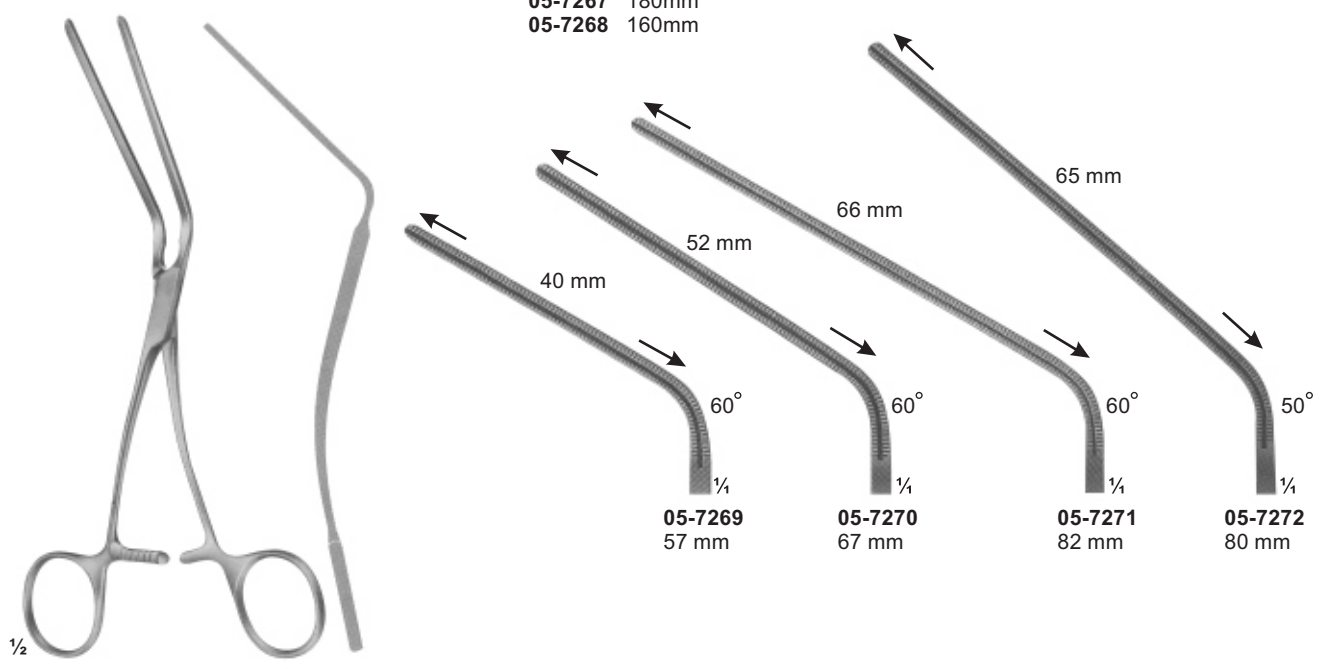

1/2
05-7269 - 05-7272
05-7269 165mm
05-7270 170mm
05-7271 185mm
05-7272 185mm

05-7269 57 mm

05-7270 67 mm

05-7271 82 mm

05-7272 80 mm

Multi-Purpose Clamps



1/2

05-7273 - 05-7282

DARDIK

05-7273	150 mm	05-7278	170 mm
05-7274	150 mm	05-7279	170 mm
05-7275	150 mm	05-7280	170 mm
05-7276	145 mm	05-7281	160 mm
05-7277	130 mm	05-7282	135 mm

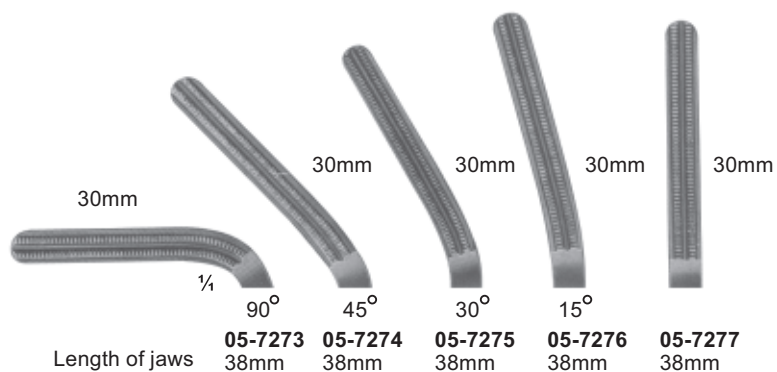

Length of jaws	05-7273 38mm	05-7274 38mm	05-7275 38mm	05-7276 38mm	05-7277 38mm
----------------	------------------------	------------------------	------------------------	------------------------	------------------------

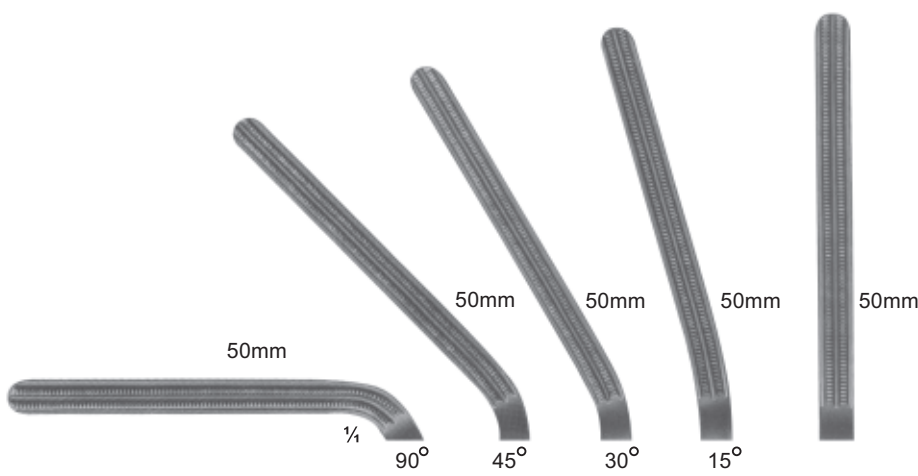

Length of jaws	05-7278 58mm	05-7279 58mm	05-7280 58mm	05-7281 58mm	05-7282 58mm
----------------	------------------------	------------------------	------------------------	------------------------	------------------------

Lung Grasping Forceps

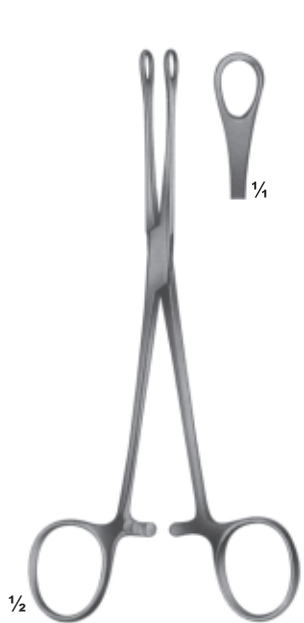

05-7283
WILLIAMS
160 mm



05-7284
TUTTLE
230 mm



05-7285
NELSON
230 mm

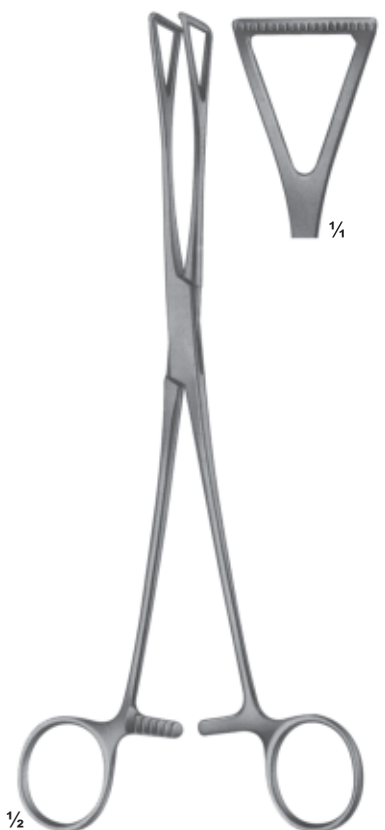

05-7286
DUVAL
230 mm



05-7287 - 05-7289
BABCOCK
05-7287 170 mm
05-7288 215 mm
05-7289 220 mm

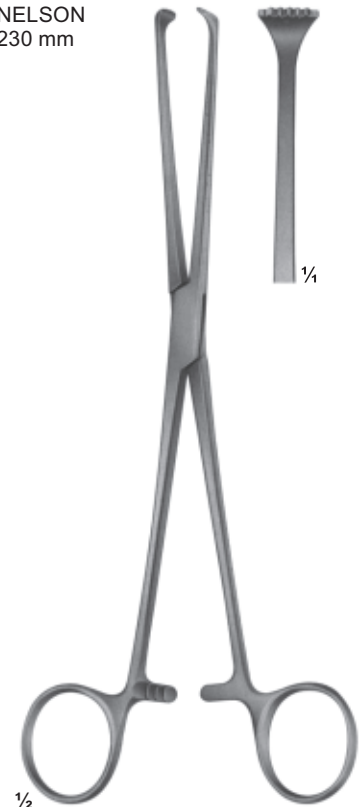
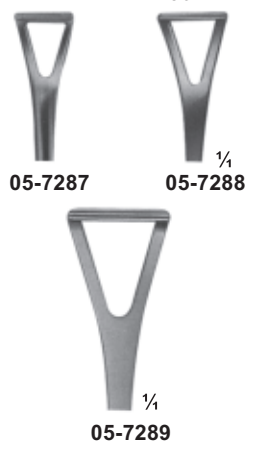

05-7290
ALLIS
220 mm

Dissecting And Ligature Forceps

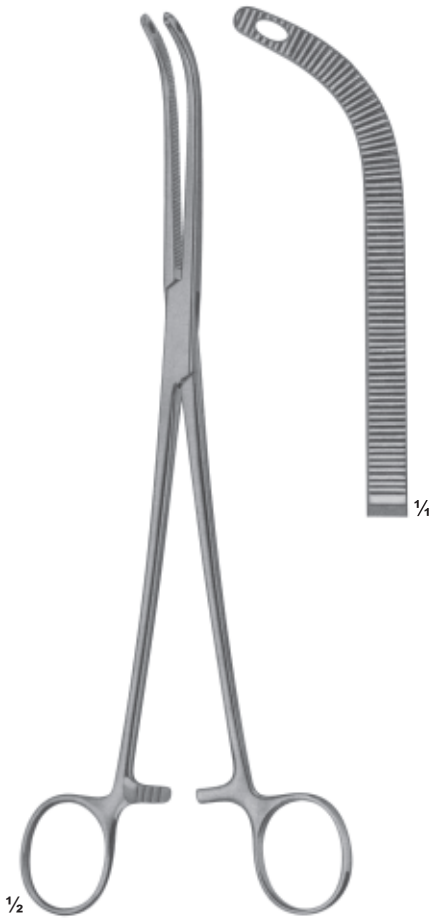

05-7291
FINOCHIETTO
245 mm

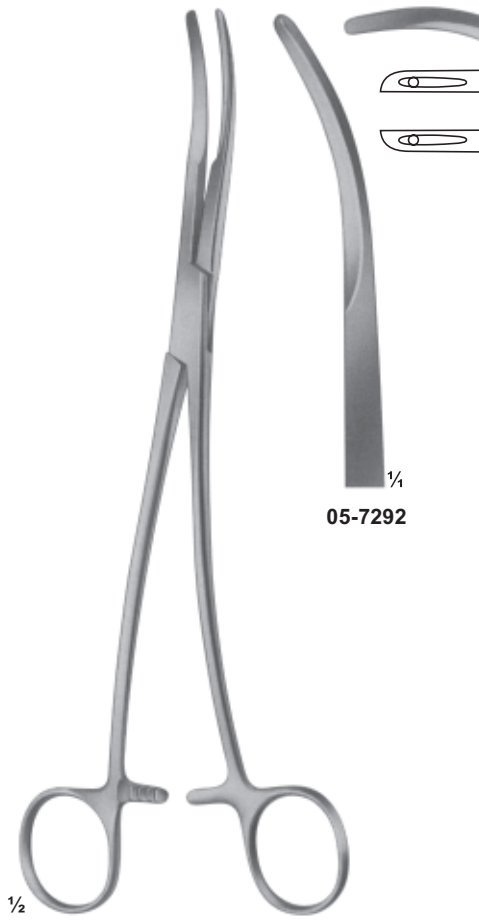

05-7292

05-7293

05-7292 - 05-7293
SEMB
240 mm

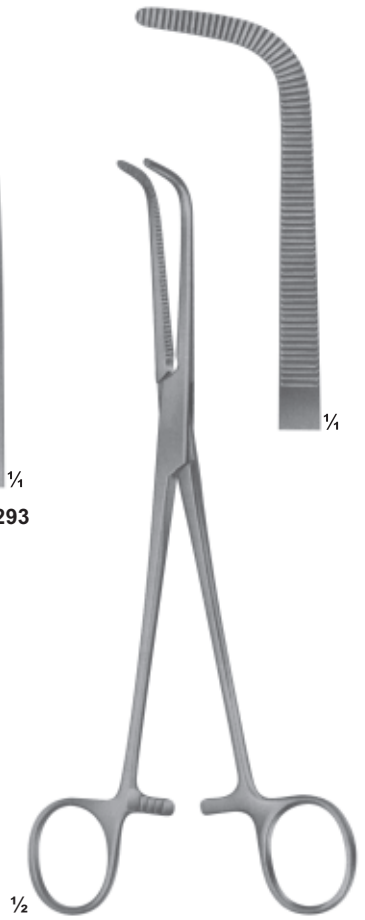

05-7294
WIKSTROEM
205 mm

Dissecting And Ligature Forceps, Vessel Clamps



05-7295
MIXTER
230 mm



05-7296 220 mm
05-7297 250 mm

05-7296 - 05-7297
MIXTER

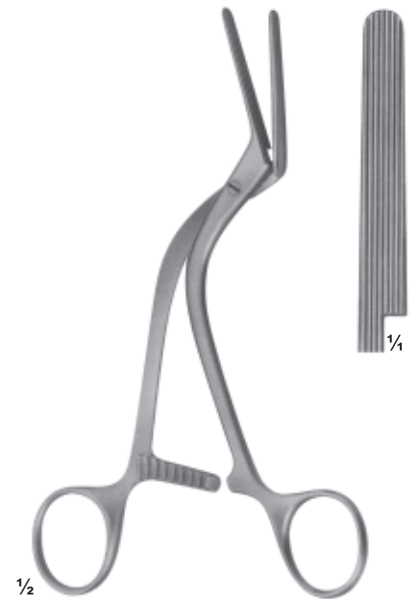

05-7298
HOEPFNER
Vessel clamp
160 mm

Vena Cava Clamps



05-7299
SATINSKY
Anastomosis clamps
265 mm

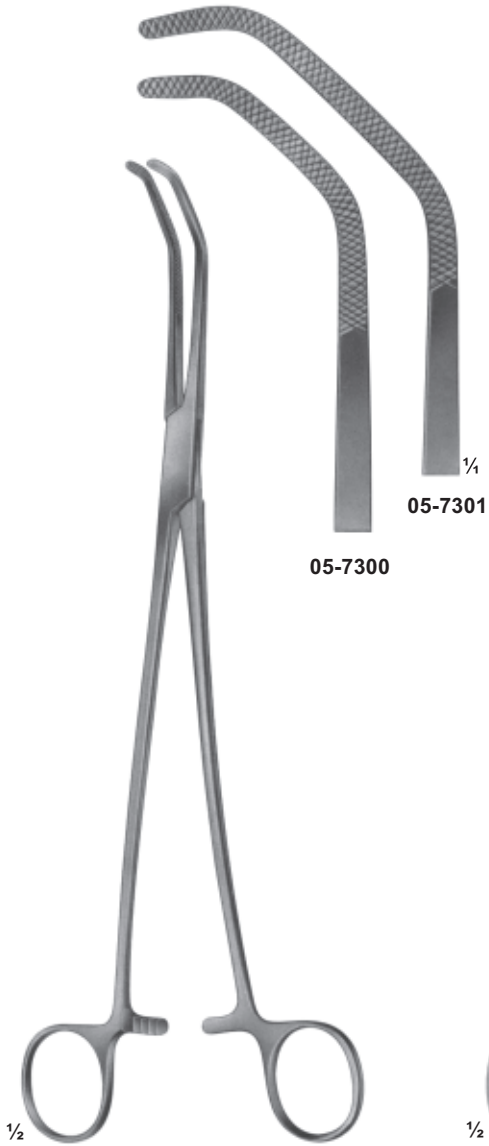

05-7300 - 05-7301
SATINSKY
Anastomosis clamps
265 mm

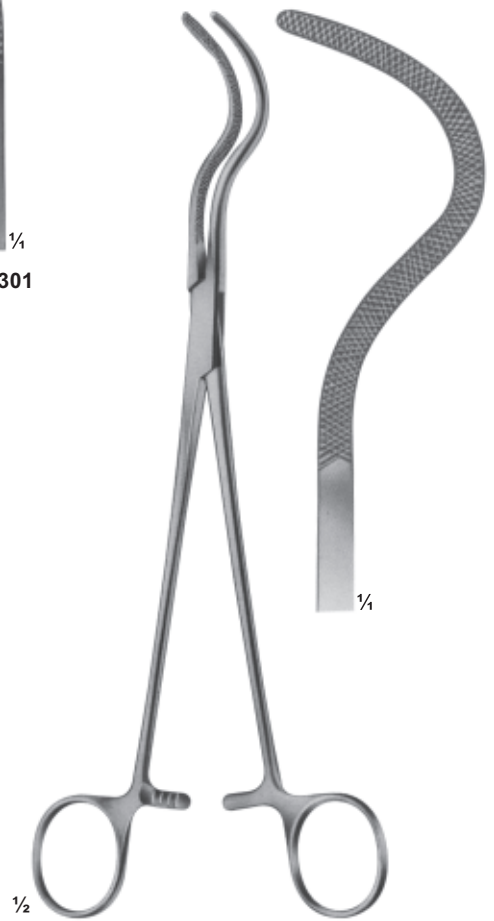

05-7302
HARKEN
Anastomosis clamps
240 mm



05-7303
PERTUISET
Carotid Clamp
90 mm

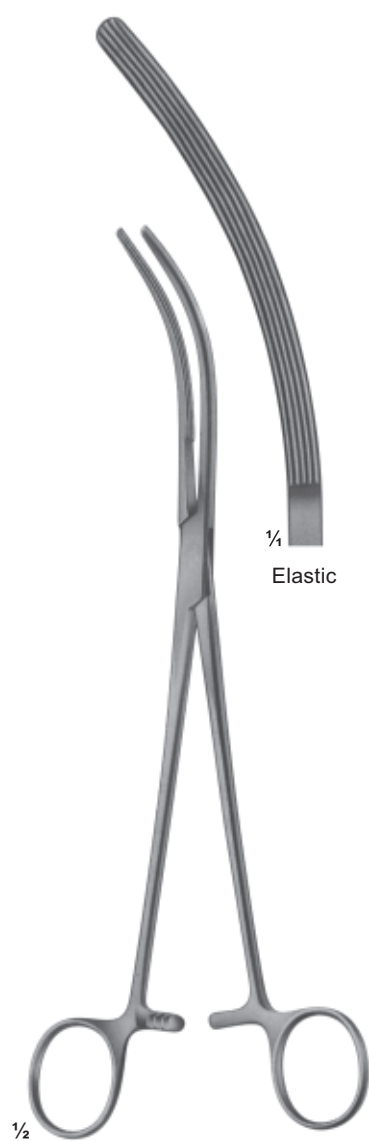

05-7304
CRAFOORD-SELLORS
240 mm

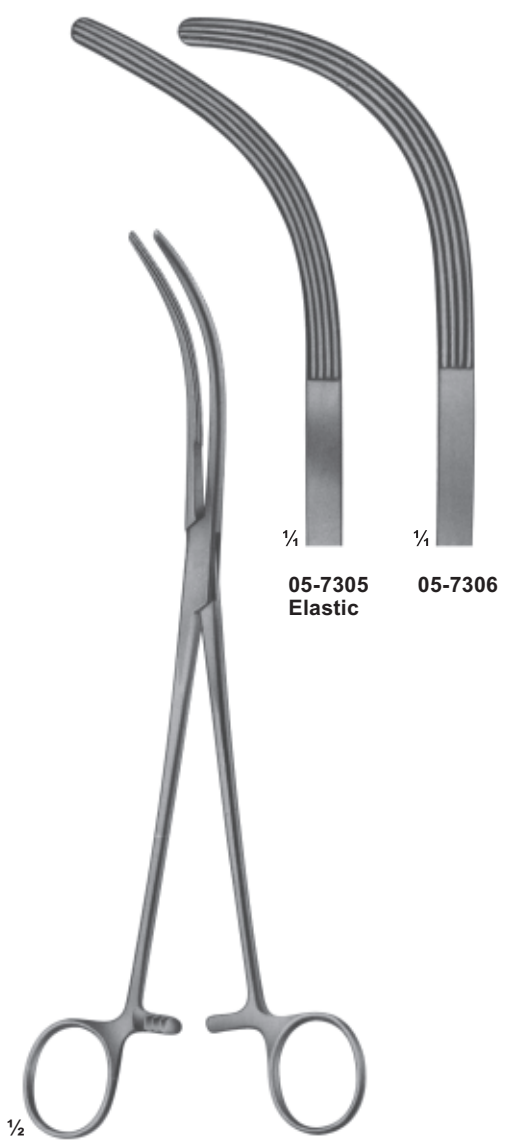

05-7305 - 05-7306
CRAFOORD
240 mm

Bronchus Forceps



05-7307
PRICE THOMAS
225 mm



05-7308
jaws with pins

05-7309
jaws with pins

05-7308 - 05-7309
PRICE THOMAS
225 mm

Sternum Instruments And Rib Shears



05-7310
SCHUMACHER
Sternum shears
210 mm



05-7311
LEBSCHÉ
Sternum chisel
200 mm



05-7312
230 mm



05-7313
COLLIN
195 mm



05-7314
GLUCK
190 mm



05-7315
BETHUNE
340 mm



05-7316
BRUNNER
Universal Pattern
340 mm



05-7317
GIERTZ-STILLÉ
250 mm

Rib Holding Forceps, Bone Cutting Forceps
Rib Rongeurs

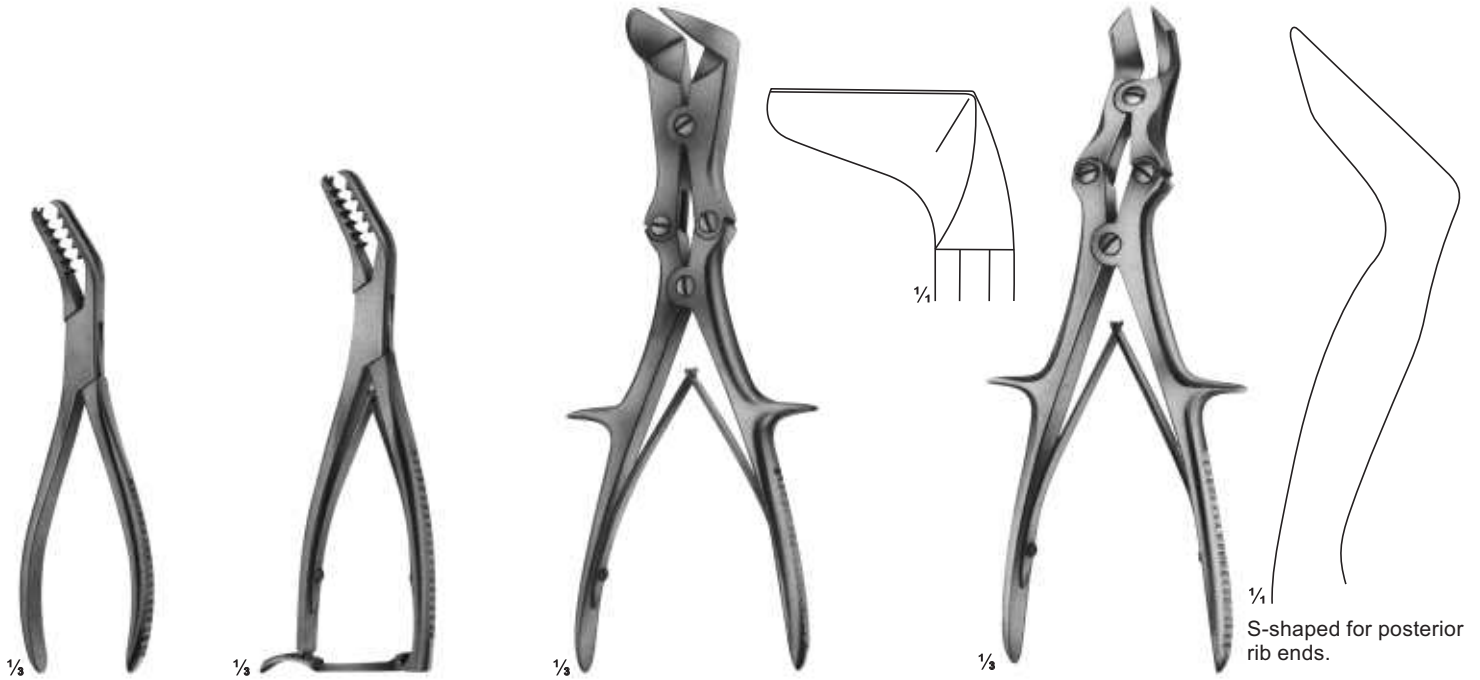

05-7318
SEMB
Rib-and Bone
Holding forceps
190 mm

05-7319
SEMB
Rib-and Bone
Holding forceps
190 mm

05-7320
LISTON-STILLE
265 mm

05-7321
LISTON-KEY-HORSLEY
(Tudor Edwards)
255 mm

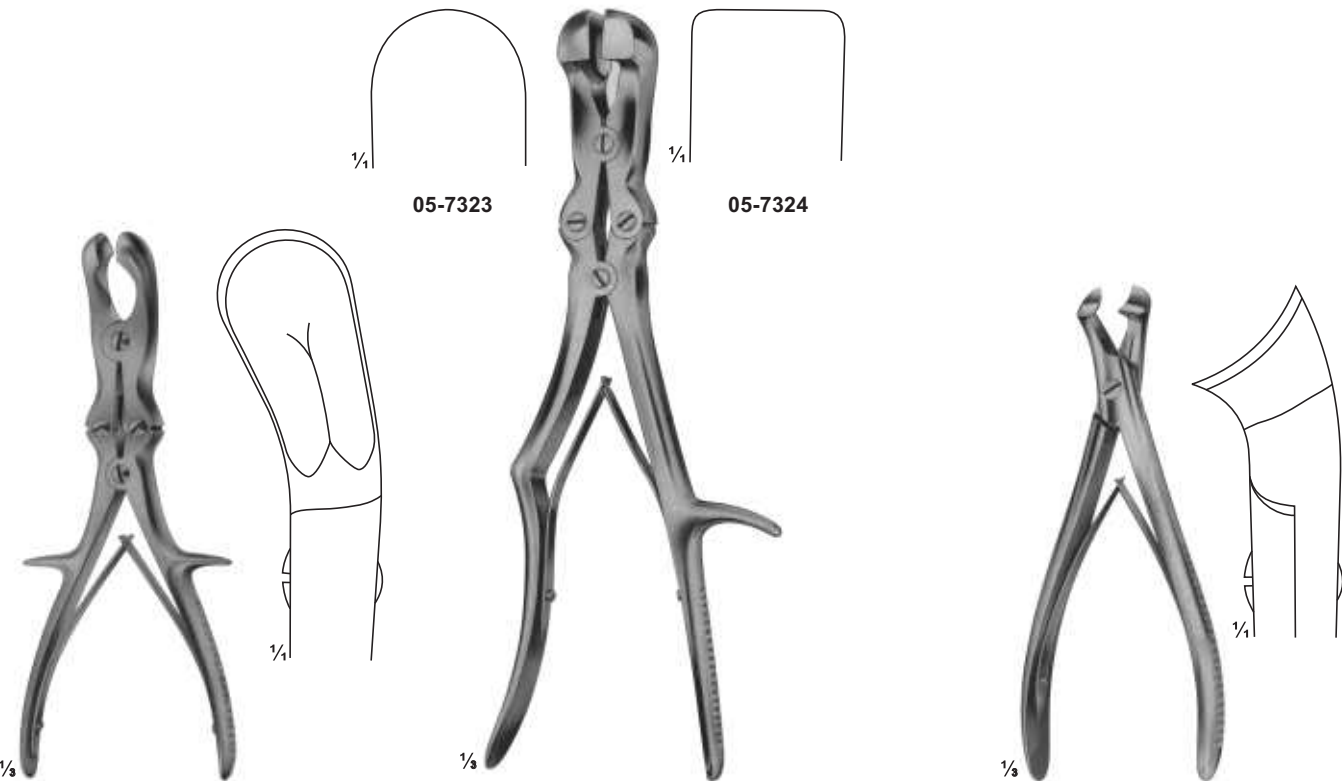

05-7322
SEMB
Rib Rongeur to shorten
the rib stumps
240 mm

05-7323 - 05-7324
SAUERBRUCH-CORYLLOS
Rib rongeurs to shorten
the rib stumps
310 mm

05-7325
MARKWALDER
Rib Rongeur to Round
the rib stumps
190 mm

Rib Raspatories

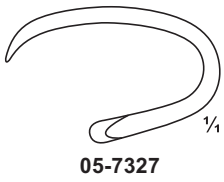
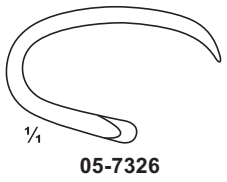

05-7326 - 05-7327
DOYEN
for children
175 mm



05-7328 - 05-7329
DOYEN
for adults
175 mm

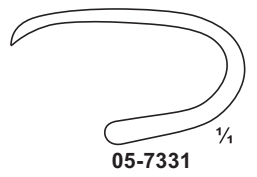
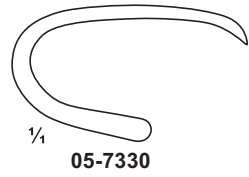

05-7330 - 05-7331
DOYEN
240 mm

Rib Raspatories



1/2
05-7332 - 05-7336
SEMB
230 mm



12 mm
1/4
05-7332
190 mm

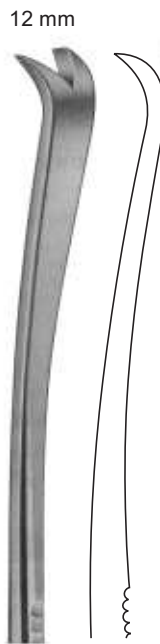

12 mm
05-7333
230mm

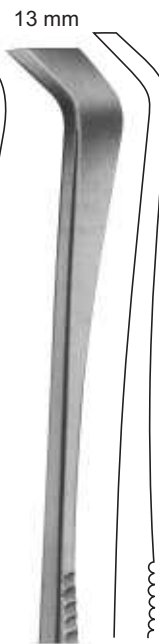

13 mm
05-7334
230mm

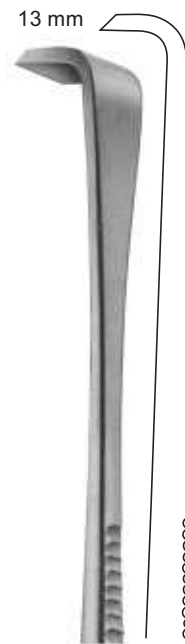

13 mm
05-7335
230mm



15 mm
05-7336
230mm

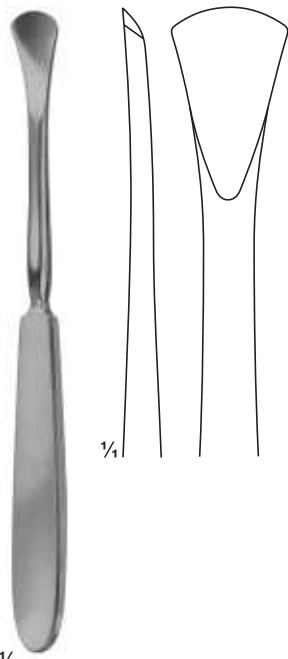

1/2
05-7337
LANGENBECK
190 mm

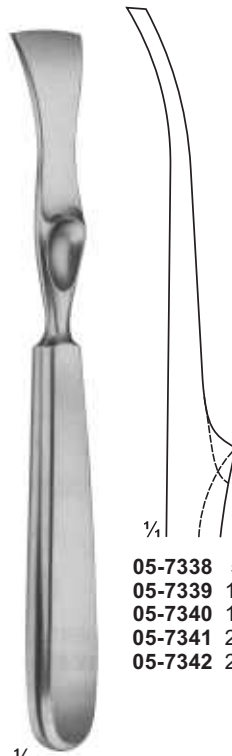

1/2
05-7338 - 05-7342
LAMBOTTE
215 mm

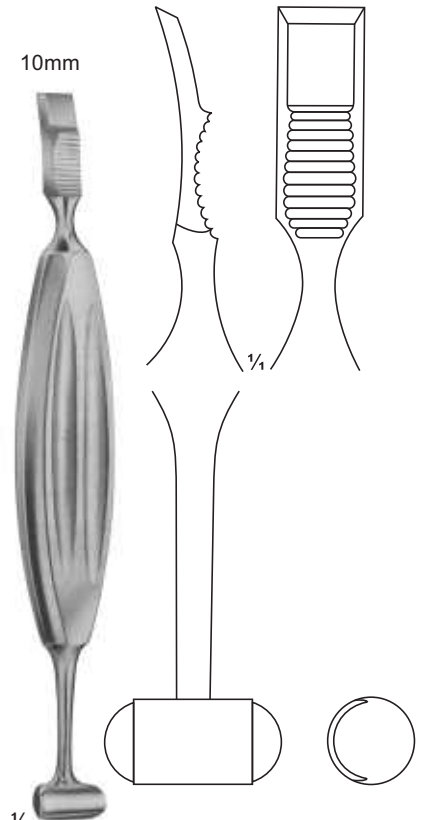

10mm
1/4
05-7338 5 mm
05-7339 10 mm
05-7340 15 mm
05-7341 20 mm
05-7342 25 mm
1/2
05-7343
ALEXANDER
210 mm

Rib Spreaders

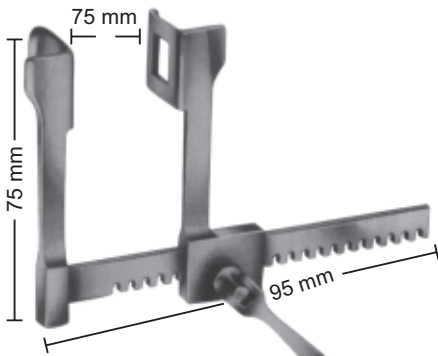

05-7344
FINOCHIETTO
Blades
18X21 mm

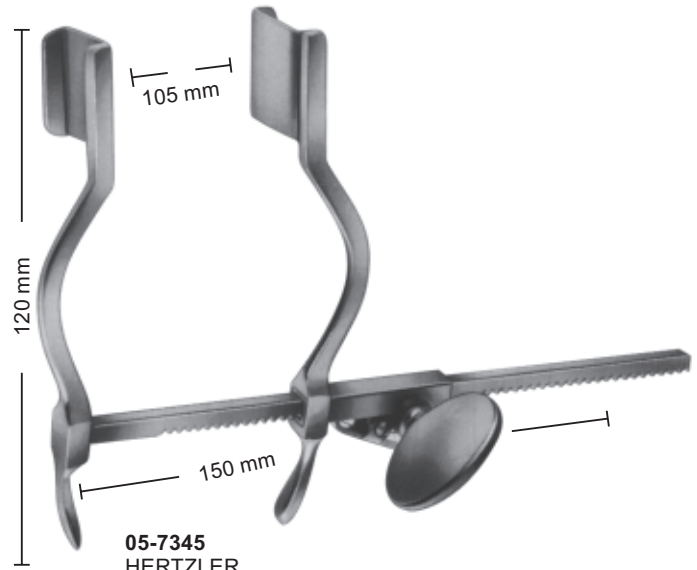

05-7345
HERTZLER
Blades
20X25 mm

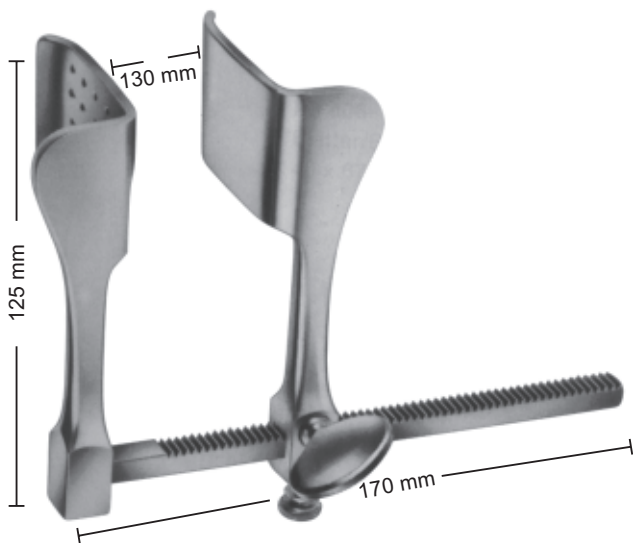

05-7346
TUFFIER
Blades
43X53 mm

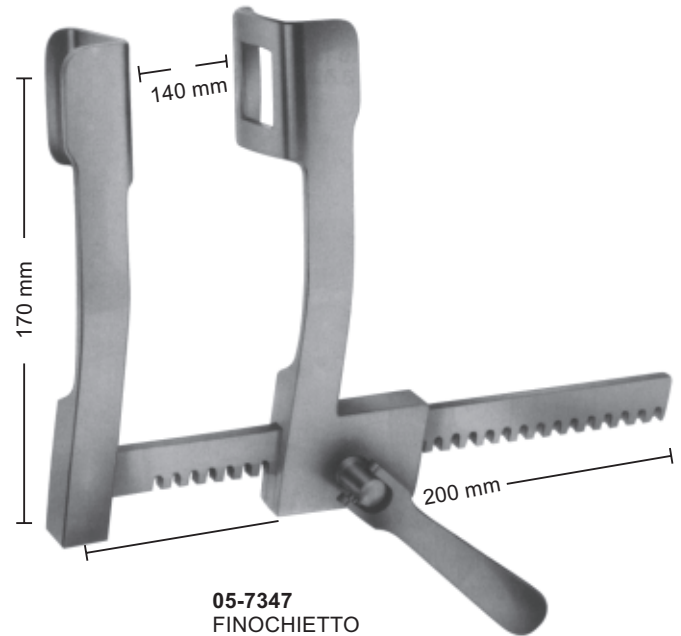

05-7347
FINOCHIETTO
Blades
36X45 mm

Rib Spreaders

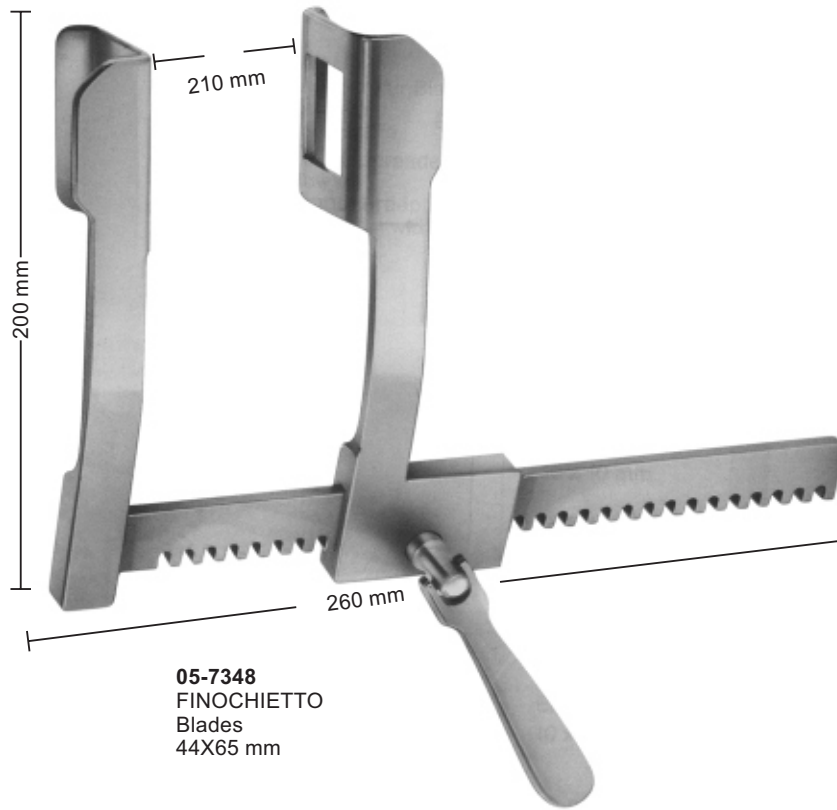

05-7348
FINOCHIETTO
Blades
44X65 mm

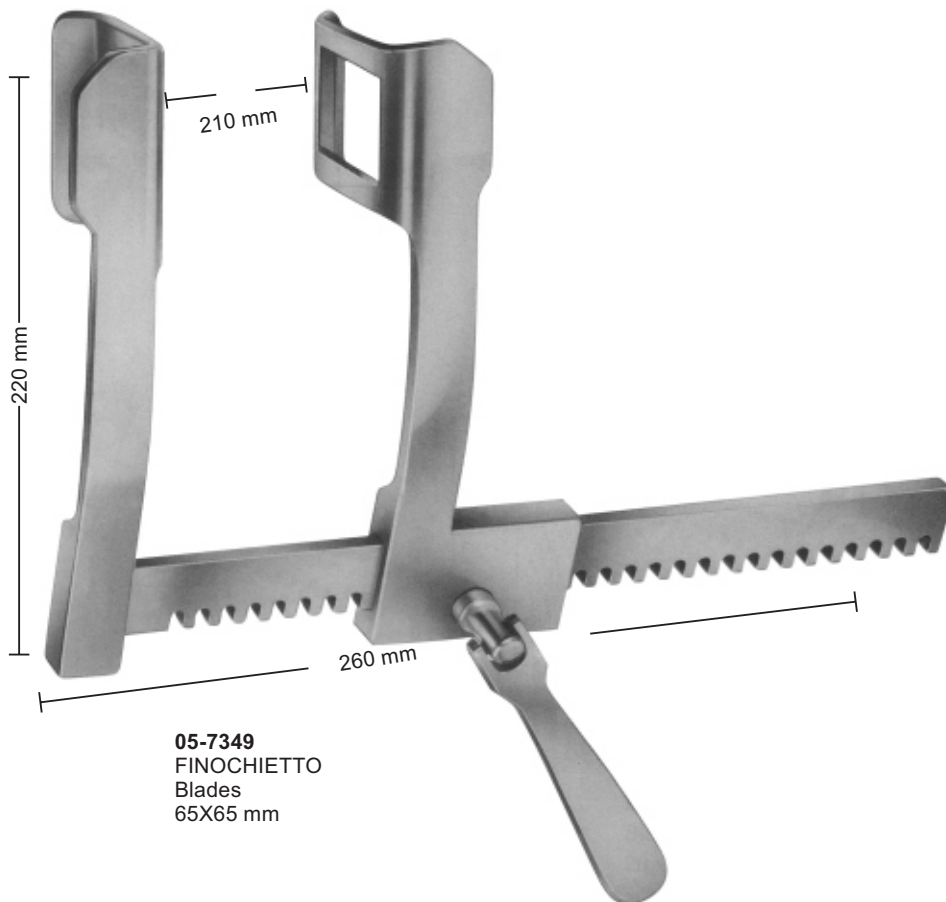

05-7349
FINOCHIETTO
Blades
65X65 mm

Rib Spreaders

05-7351
Blades
30x80 mm



05-7352
Blades
40x67 mm



05-7353
Blades
80x67 mm



220 mm

220 mm

300 mm

05-7354
Blade, Only, for preparation
of a. Mammaria, 25.5x80mm

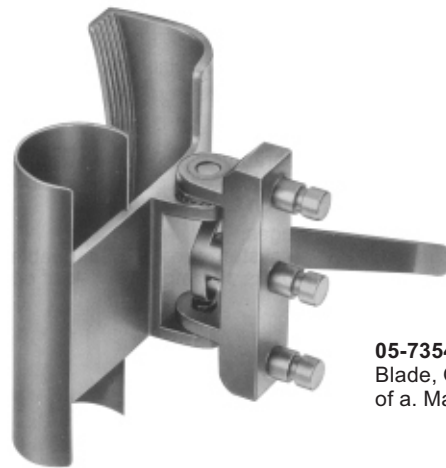

05-7350
FINOCHIETTO-BURFORD
with 2 pairs of blades
(05-7352 - 05-7353)

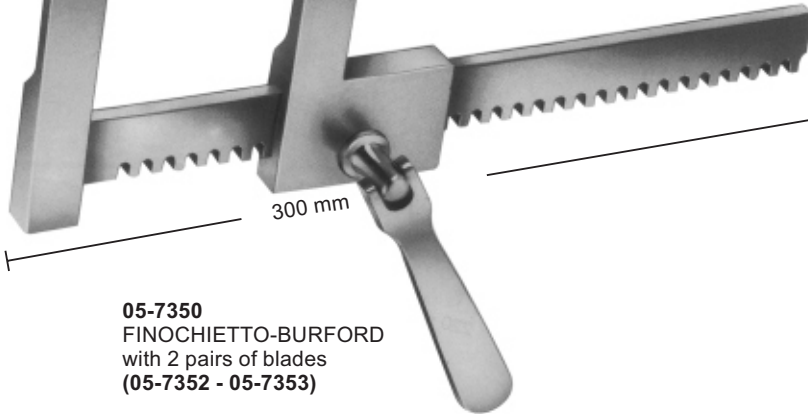

Rib Spreaders

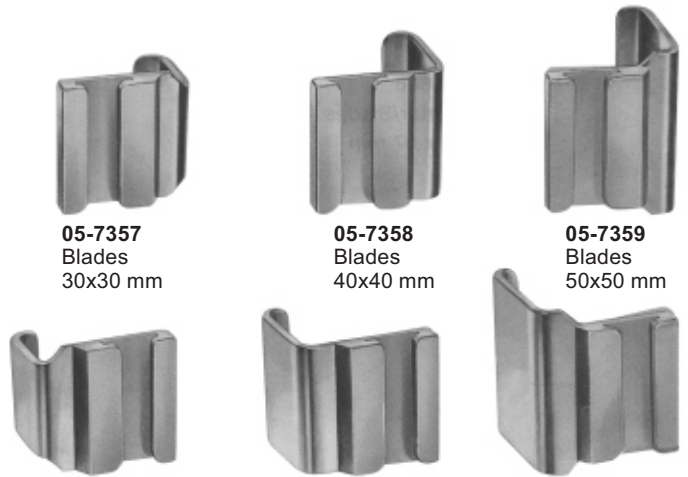
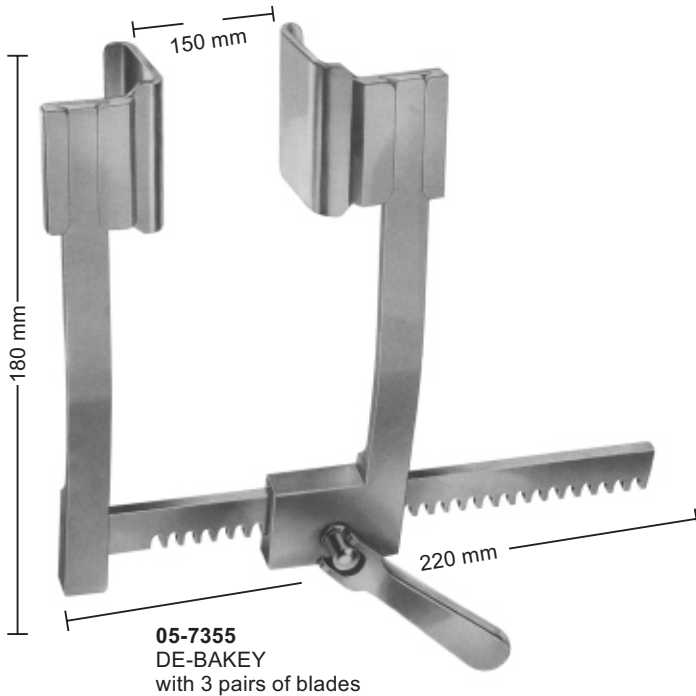

Components for **05-7355**
Spreader only Blades only
05-7357 30x30mm
05-7358 40x40mm
05-7359 50x50mm

The Blades are delivered in Pairs.

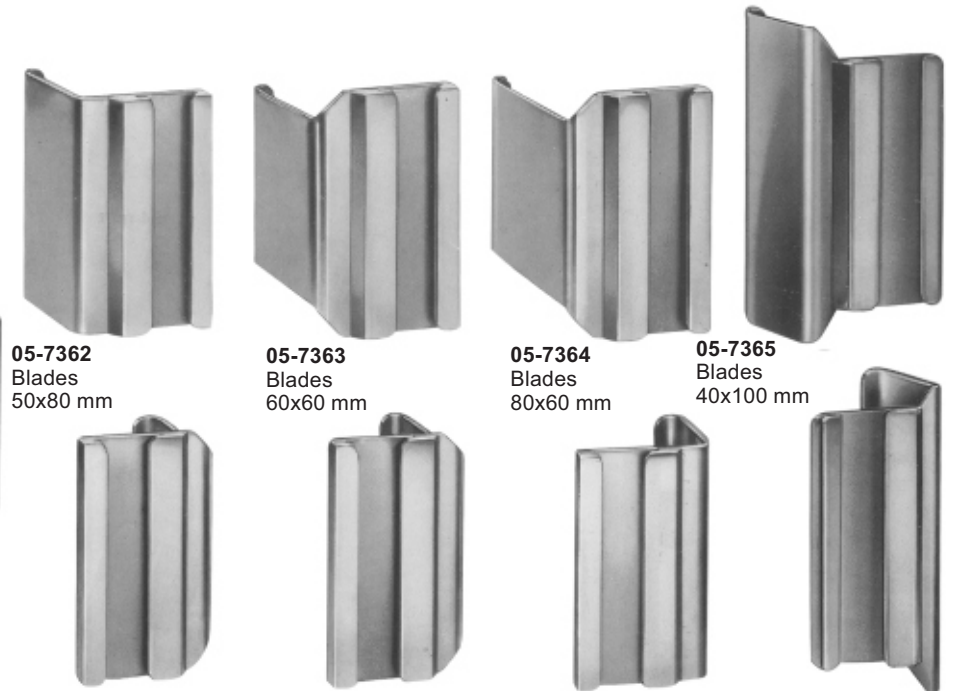
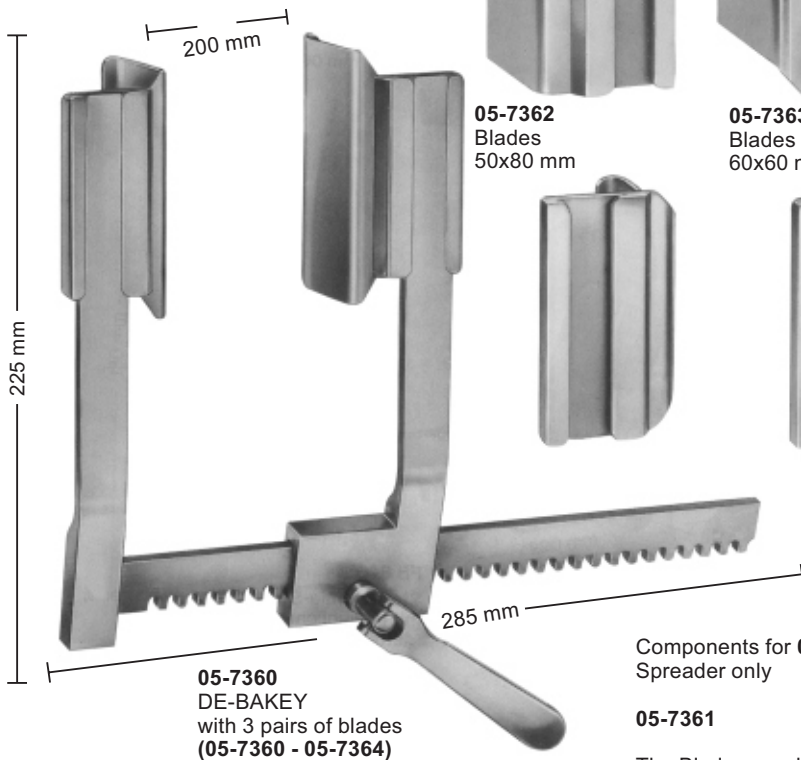

Components for **05-7360**
Spreader only Blades only
05-7361 **05-7362** 50x80mm
 05-7363 60x60mm
 05-7364 40x100mm

The Blades are delivered in Pairs.

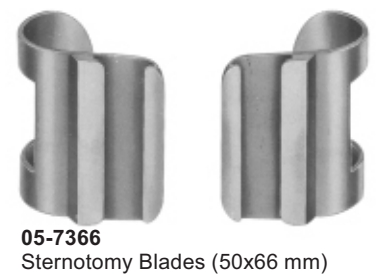

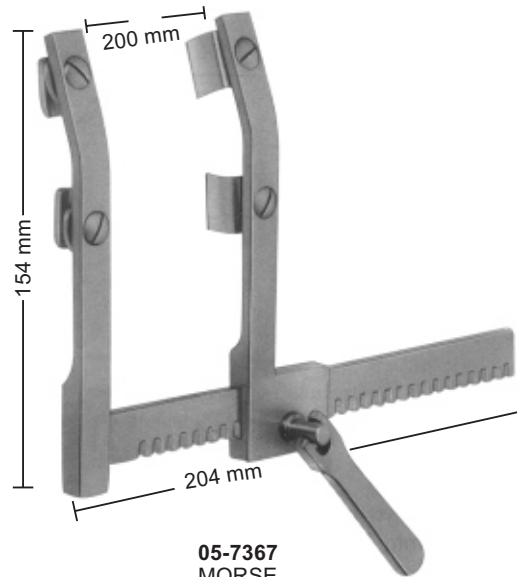

05-7367
MORSE
Sternotomy spreader
for children, with moveable
double, blades each blade
12x20 mm

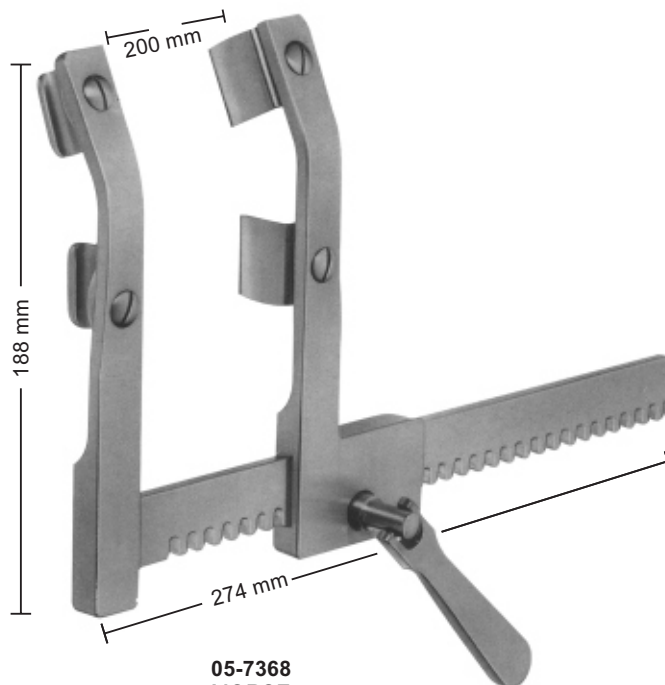

05-7368
MORSE
Sternotomy spreader
for adults, with moveable
double, blades each blade
19x19 mm

Sternotomy- Spreaders

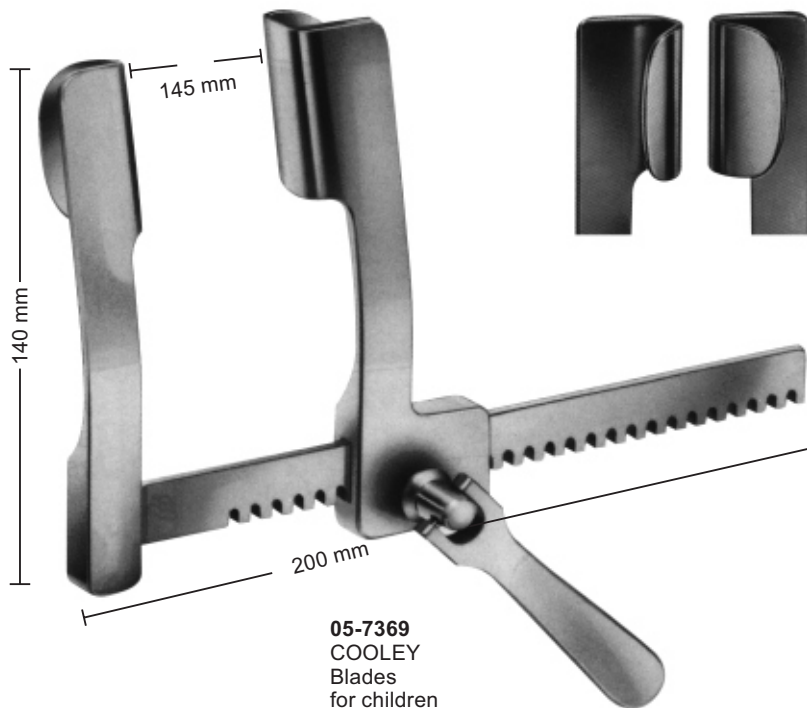

05-7369
COOLEY
Blades
for children
21x45mm

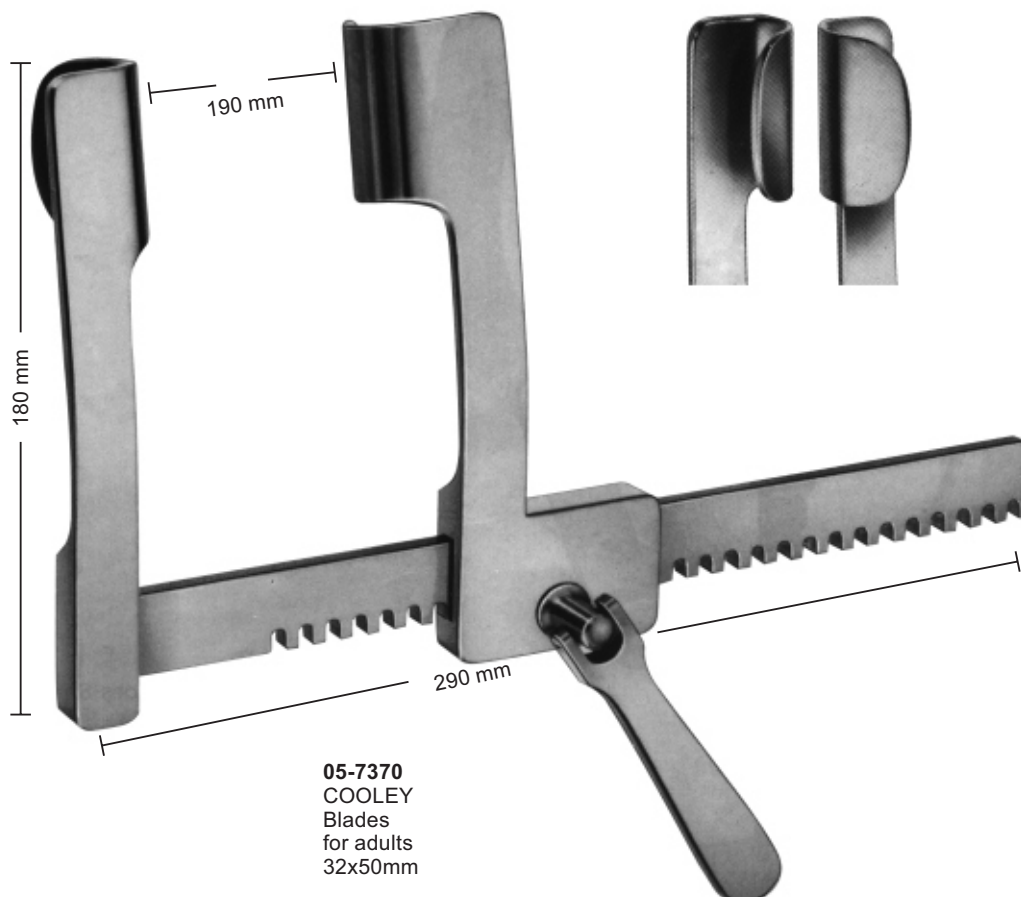

05-7370
COOLEY
Blades
for adults
32x50mm

Thoracic Retractors



05-7371
Blades
75x75 mm



05-7373
Blades
42x65 mm

Blades with Ball Snap System
Delivery: in Pairs

- 05-7371 - 05-7373**
Thoracic Retractor (Mercedes-Retractor)
complete consisting of:
05-7371 Retractor only
05-7372 1 Pair of blades 75x75 mm
05-7373 1 Pair of blades 42x65 mm

Rib Spreaders-and Contractors



05-7374
SELLORS
 Rib spreader-and contractor
 with swivel blades
 200 mm



05-7375
BAILEY
 150 mm



05-7376
 for children

05-7377
 for adults

05-7376 - 05-7377
BAILEY
 200 mm

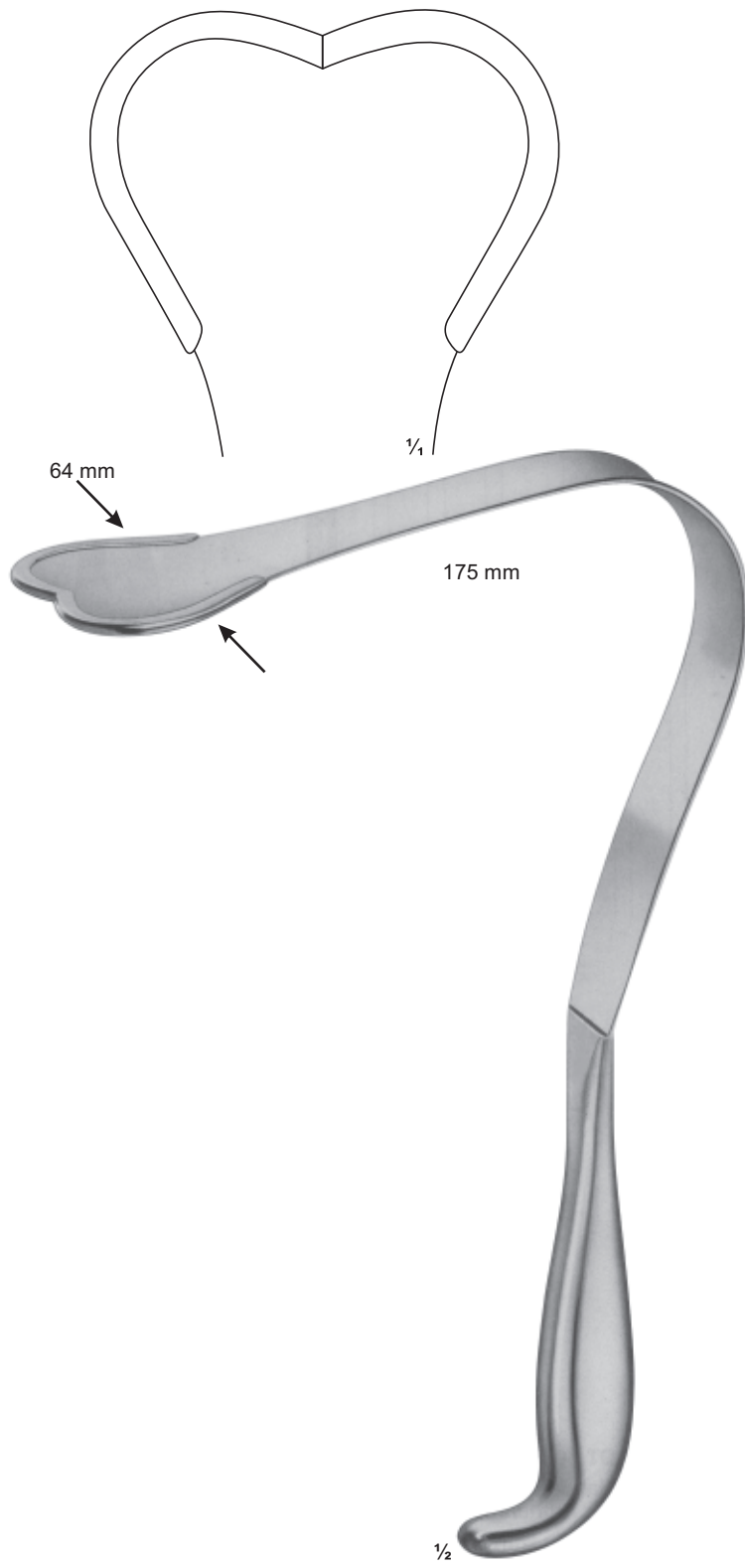

05-7378
HARRINGTON-PEMBERTON
flexible
295 mm

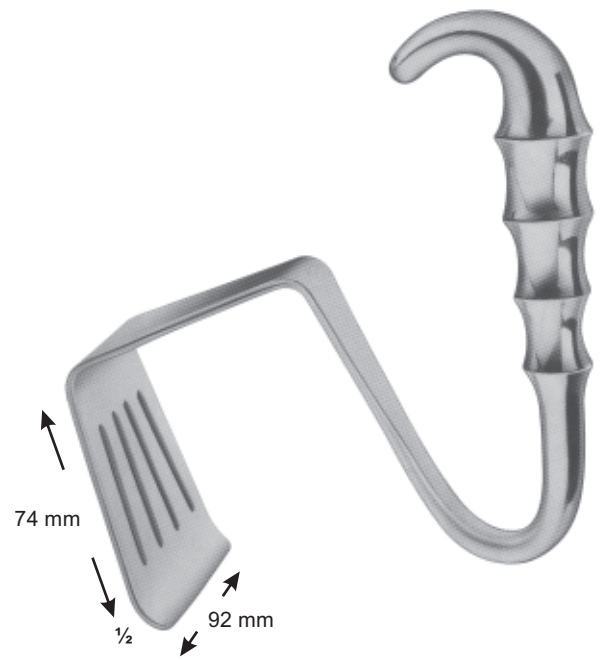

05-7379
DAVIDSON
Scapula retractor

Lung Spatulas, Suction Cannulae

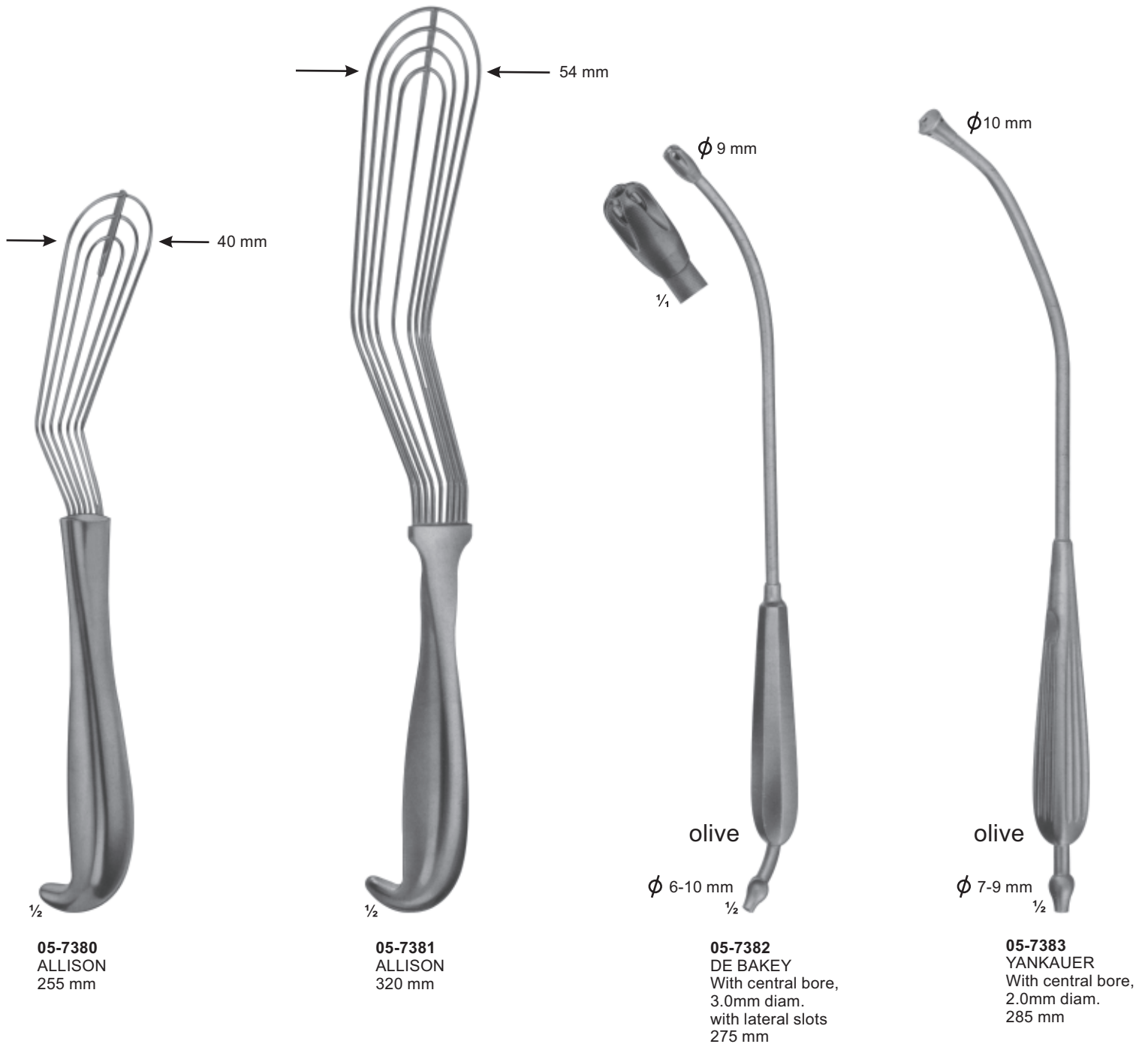

Angled positions for punchus

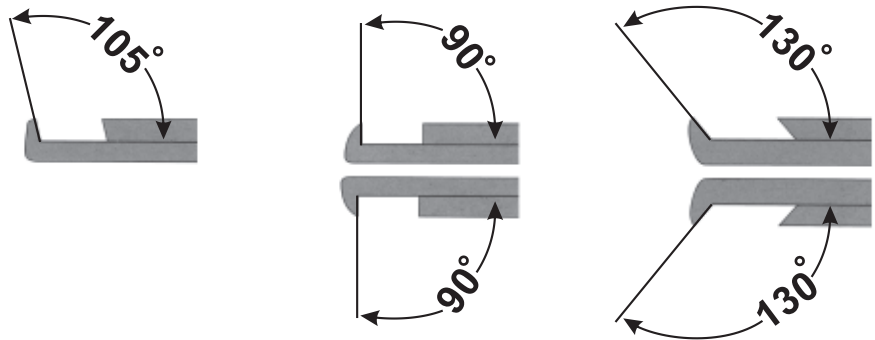

90° upwards cutting

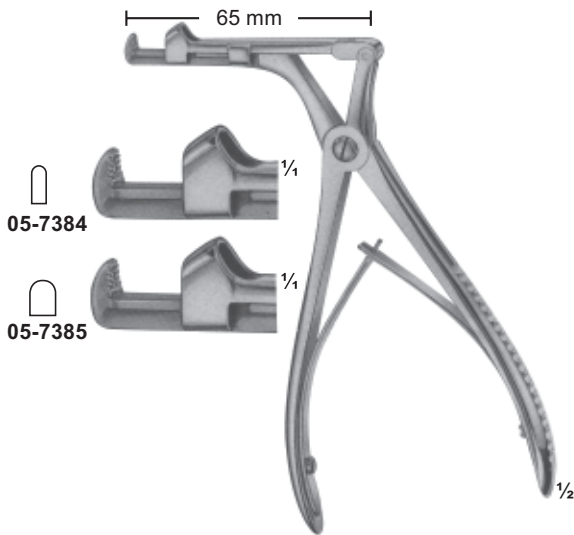

05-7384 - 05-7385
CITELLI
05-7384 2mm
05-7385 3.5mm

90° upwards cutting

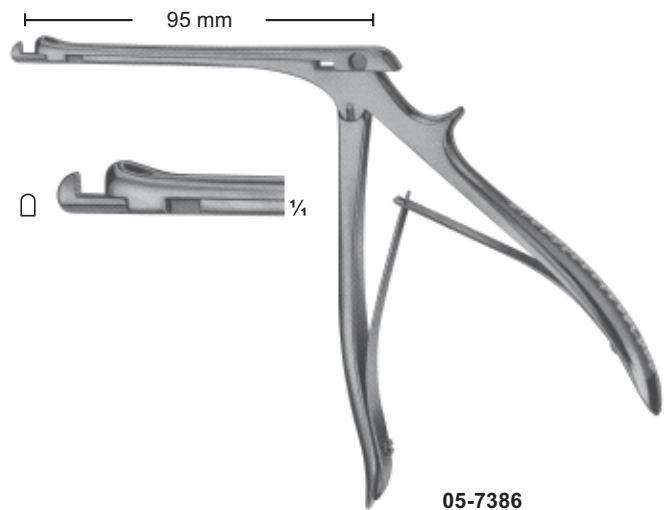

05-7386
CITELLI- BEYER
1,8 mm

Punches

90° upwards cutting

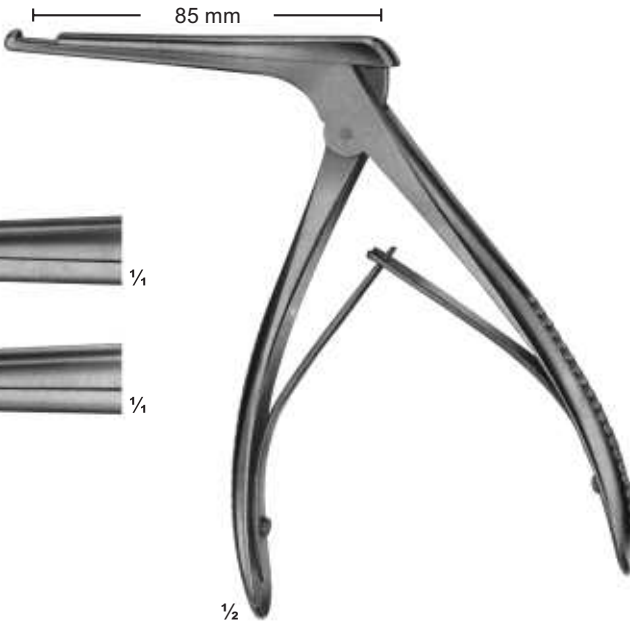

05-7387
4 mm



05-7388
5 mm



05-7387 - 05-7388
KERRISON

90° upwards cutting

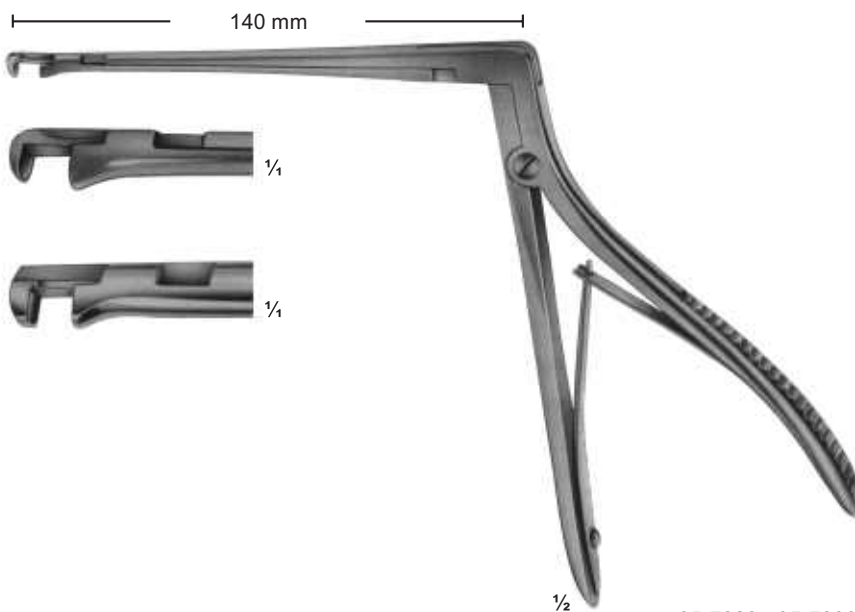

05-7389
3,3 mm



05-7390
4,0 mm



05-7389 - 05-7390
HAJEK-KOFLER

Punches

130° upwards cutting

KERRISON-JACOBY

05-7391
1 mm □

FERRIS-SMITH-KERRISON

05-7392
2 mm □

05-7393
3 mm □

05-7394
4 mm □

05-7395
5 mm □

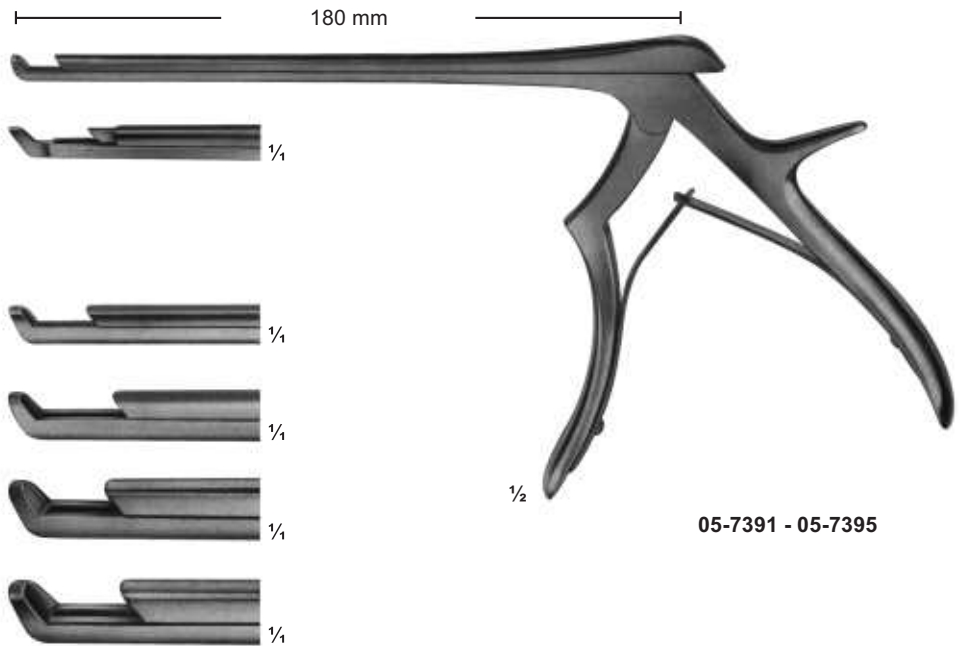

90° upwards cutting

KERRISON-JACOBY

05-7396
1 mm □

05-7397
2 mm □

FERRIS-SMITH-KERRISON

05-7398
3 mm □

05-7399
4 mm □

05-7400
5 mm □

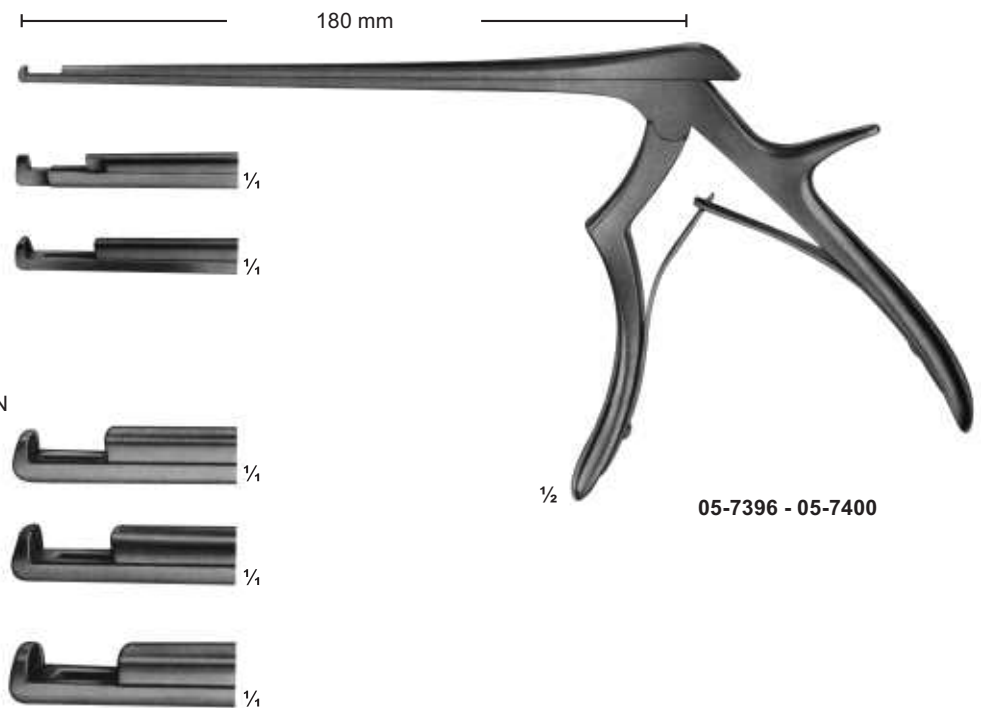

Rongeurs

Angled positions for rongeurs

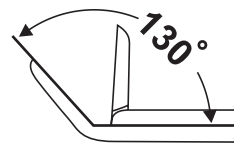
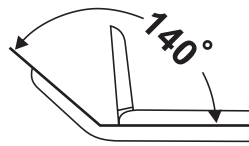
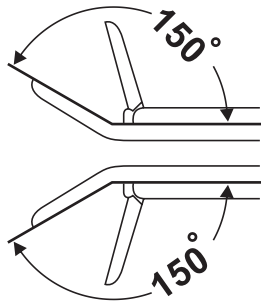

05-7401
3,0 mm

05-7402
3,6 mm

05-7403
4,2 mm

05-7404
4,8 mm

05-7405
5,8 mm

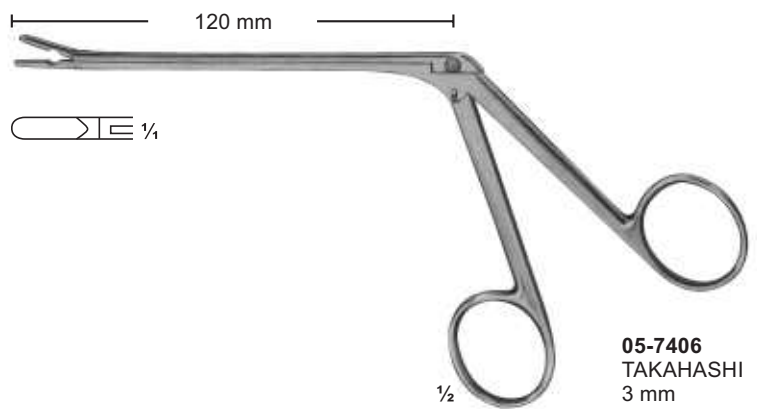
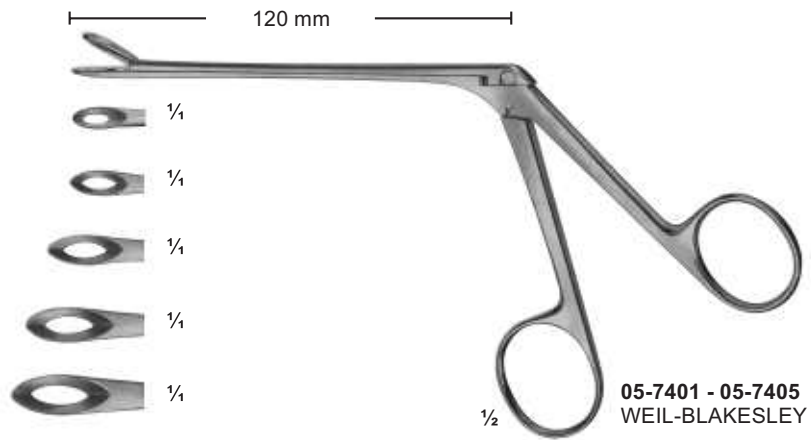

130°

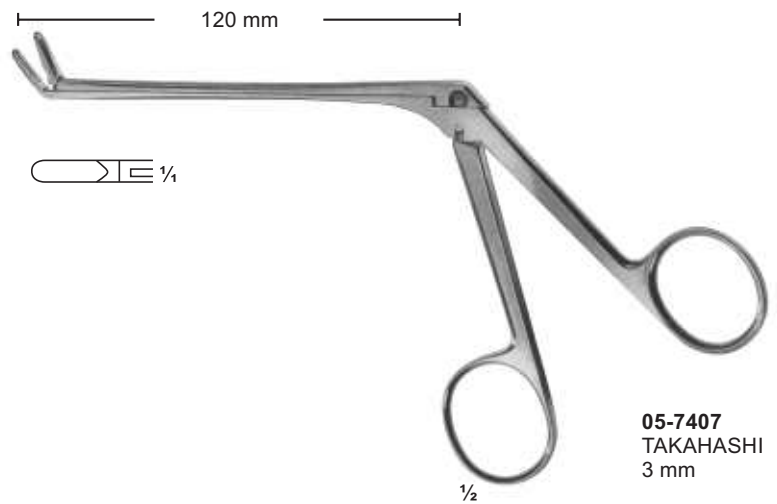

LOVE-GRUENWALD

05-7408
2 X 10 mm



05-7409
3 X 10 mm



SPURLING

05-7410
4 X 10 mm

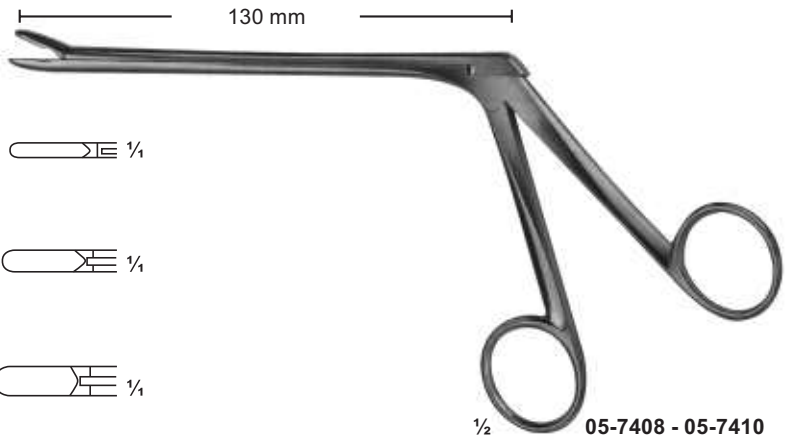

1/2 **05-7408 - 05-7410**

05-7411
2 mm



05-7412
3 mm



05-7413
4 mm



05-7414
5 mm

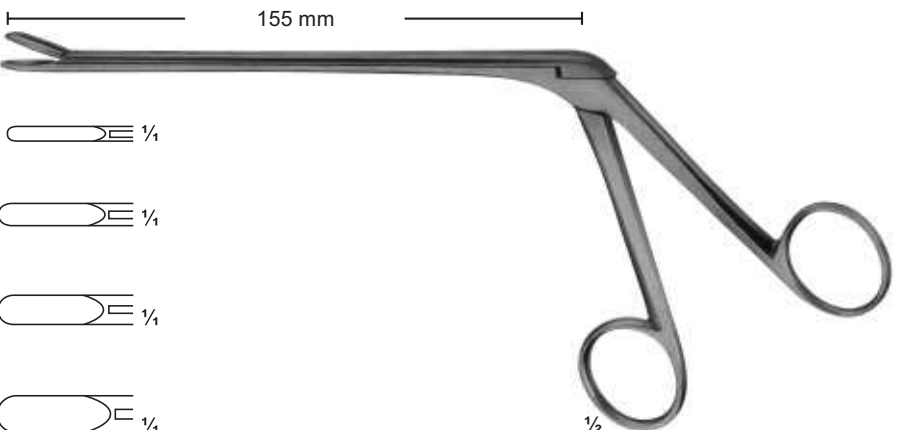

1/2 **05-7411 - 05-7414**
CASPAR

150°

05-7415
2 mm



05-7416
3 mm



05-7417
4 mm

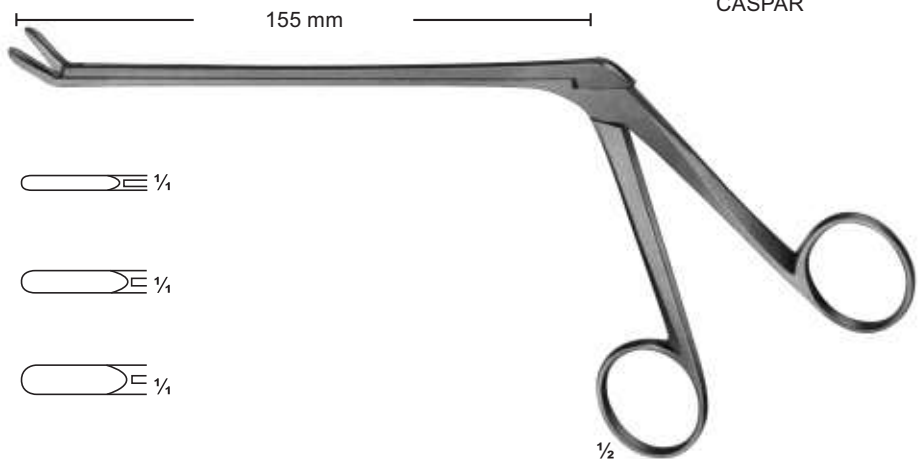

1/2 **05-7415 - 05-7417**
CASPAR

Rongeurs

150°

Lower part of jaws movable

05-7418
2 mm

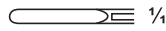

05-7419
3 mm

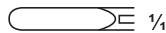

05-7420
4 mm

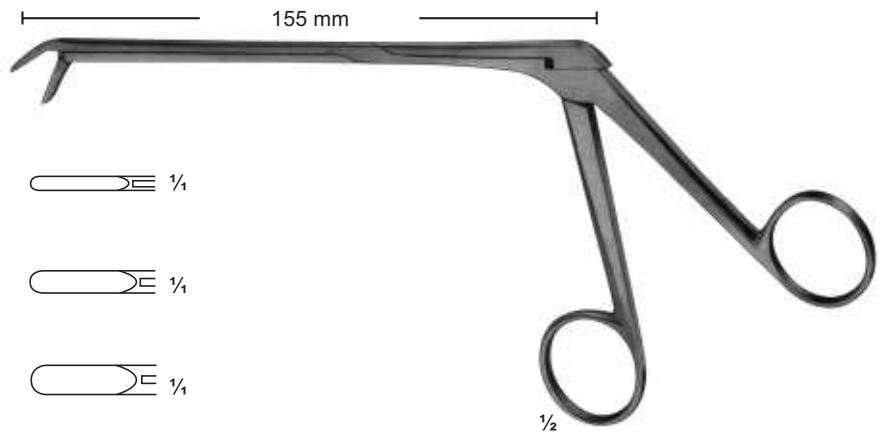

05-7418 - 05-7420
CASPAR

Length of shaft 140 mm	Length of shaft 160 mm	Length of shaft 185 mm	size of jaws
05-7421	05-7426	05-7431	2 X12 mm
05-7422	05-7427	05-7432	3 X12 mm
05-7423	05-7428	05-7433	4 X14 mm
05-7424	05-7429	05-7434	5 X14 mm
05-7425	05-7430	05-7435	6 X16 mm

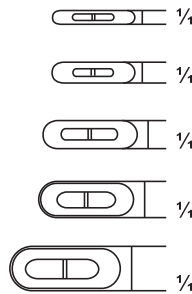

05-7421 - 05-7435
CASPAR

150°

Length of shaft 140 mm	Length of shaft 160 mm	Length of shaft 185 mm	size of jaws
05-7436	05-7439	05-7442	3 X12 mm
05-7437	05-7440	05-7443	4 X14 mm
05-7438	05-7441	05-7444	5 X14 mm

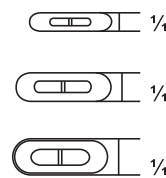

05-7436 - 05-7444
CASPAR

Rongeurs

150°

Lower part of jaw movable

Length of shaft 140 mm	Length of shaft 160 mm	Length of shaft 185 mm	size of jaws
05-7445	05-7447	05-7449	3 X 12 mm
05-7446	05-7448	05-7450	4 X 14 mm

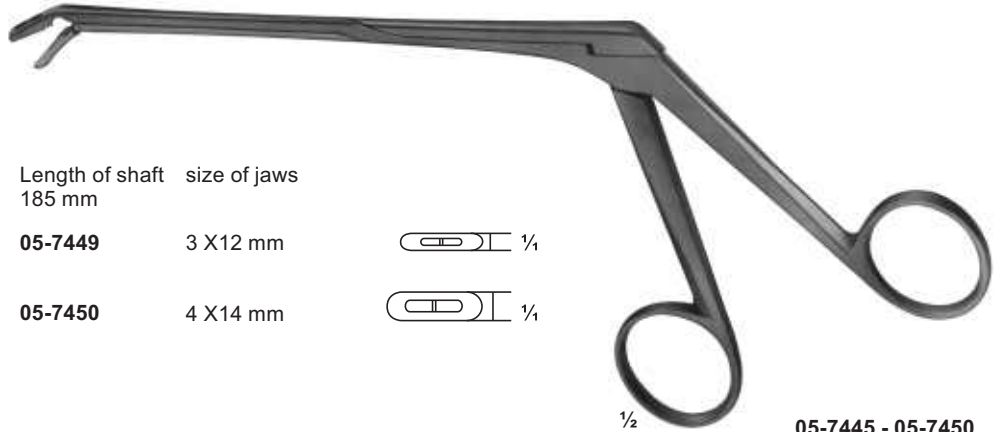

05-7445 - 05-7450
CASPAR

05-7451
2 X 10 mm
CUSHING



05-7452
3 X 10 mm
LOVE-GRUENWALD

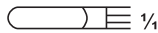

05-7453
4 X 10 mm
SPURLING

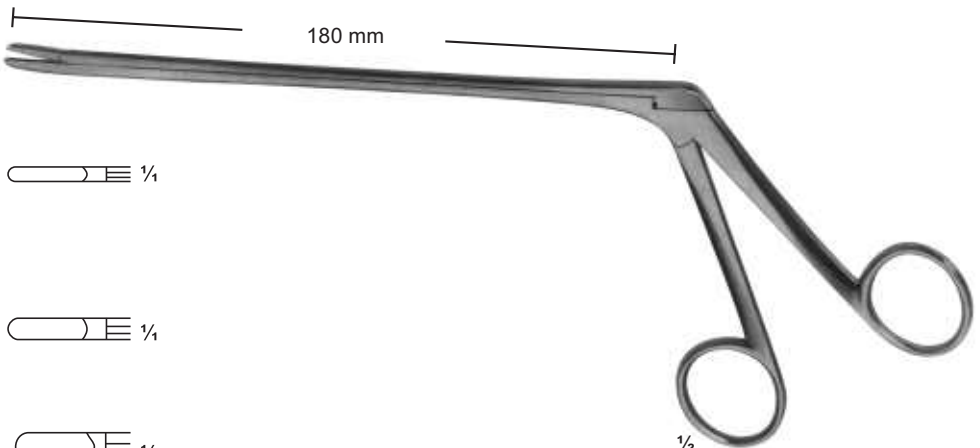
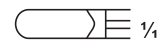

05-7451 - 05-7453

150°

05-7454
3 X 10 mm
LOVE-GRUENWALD

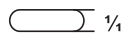

05-7455
4 X 10 mm
SPURLING

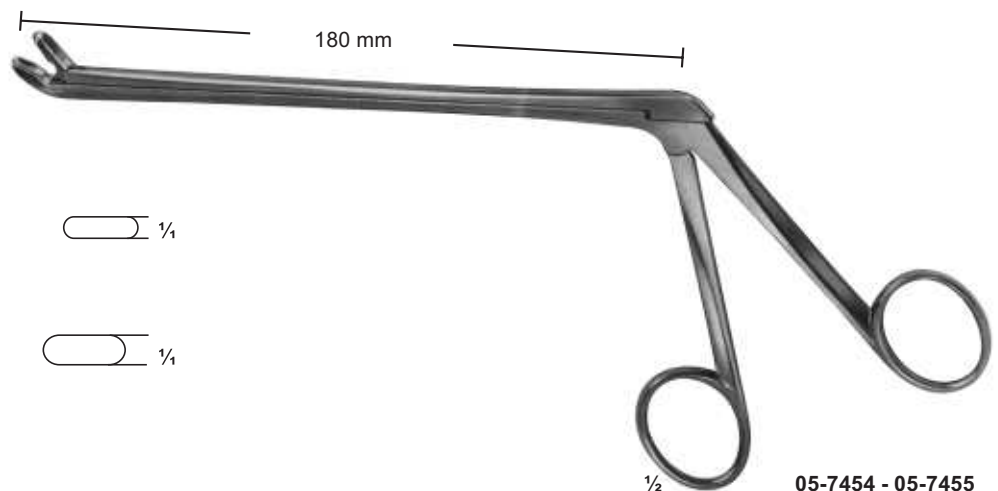

05-7454 - 05-7455

Rongeurs

150°

Upper part of jaw
movable

05-7456
3 X 10 mm
LOVE-GRUENWALD

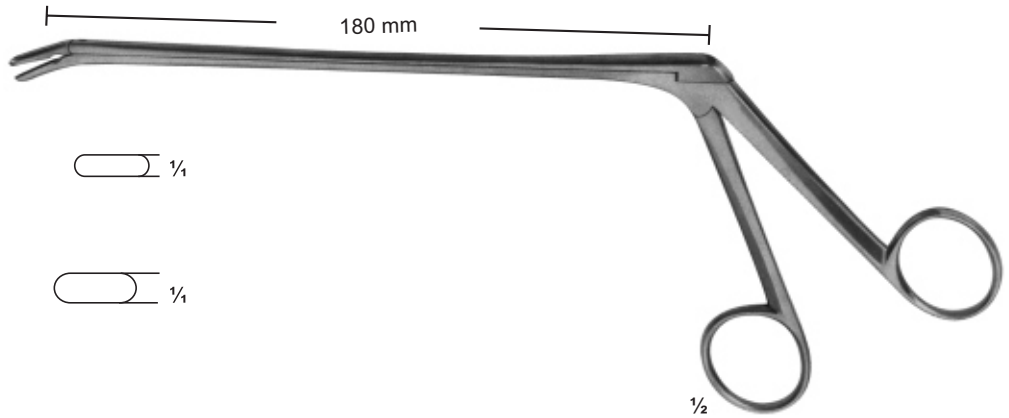

05-7457
4 X 10 mm
SPURLING



1/2

05-7456 - 05-7457

05-7458
ø 7 mm

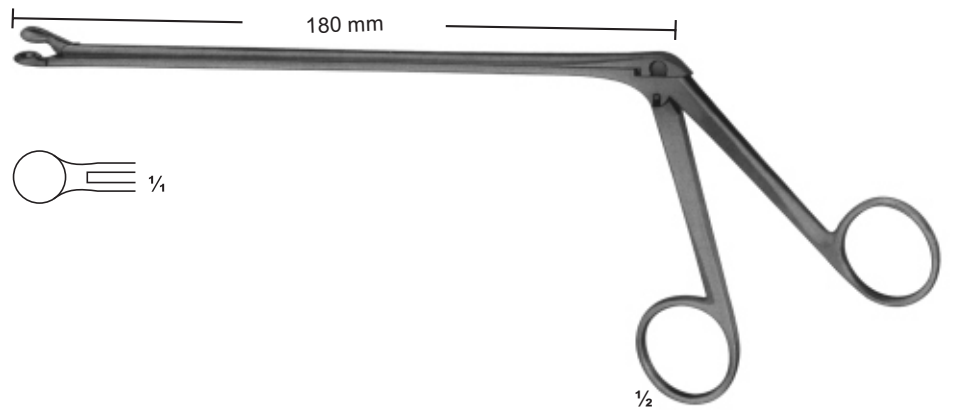

1/2

05-7458
OLDBERG

05-7459
YASARGIL
ø 2,2 mm

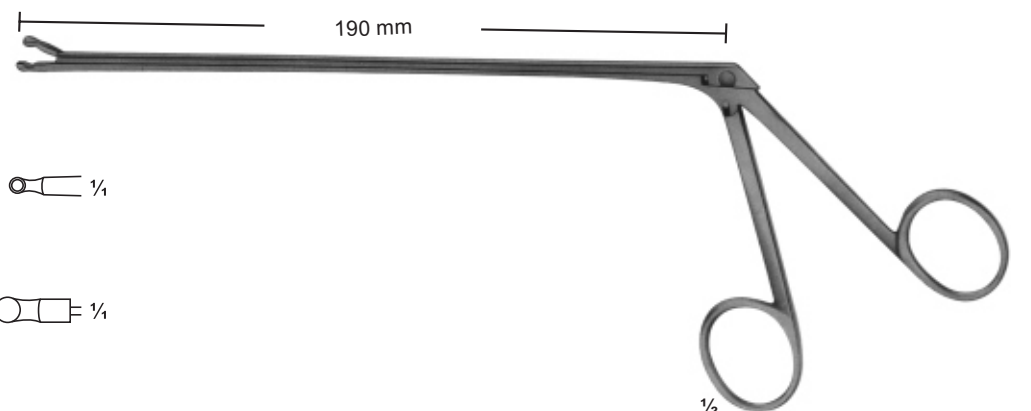

05-7460
YASARGIL
ø 3,5 mm



1/2

05-7459 - 05-7460

Rongeurs

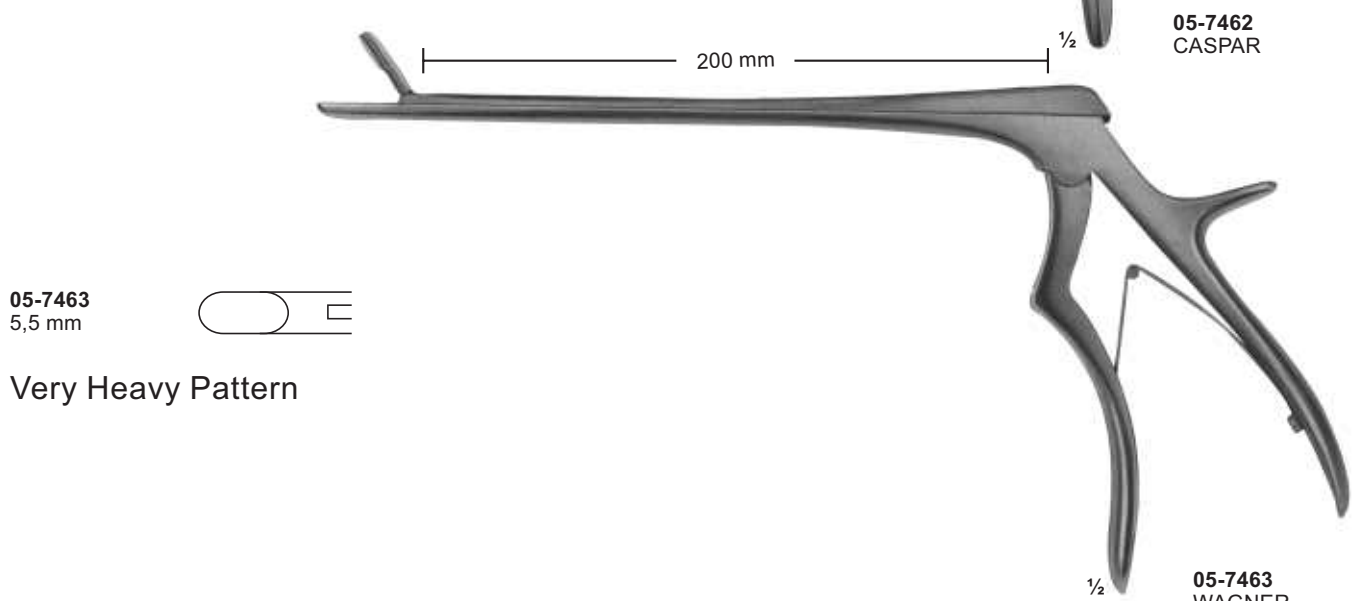
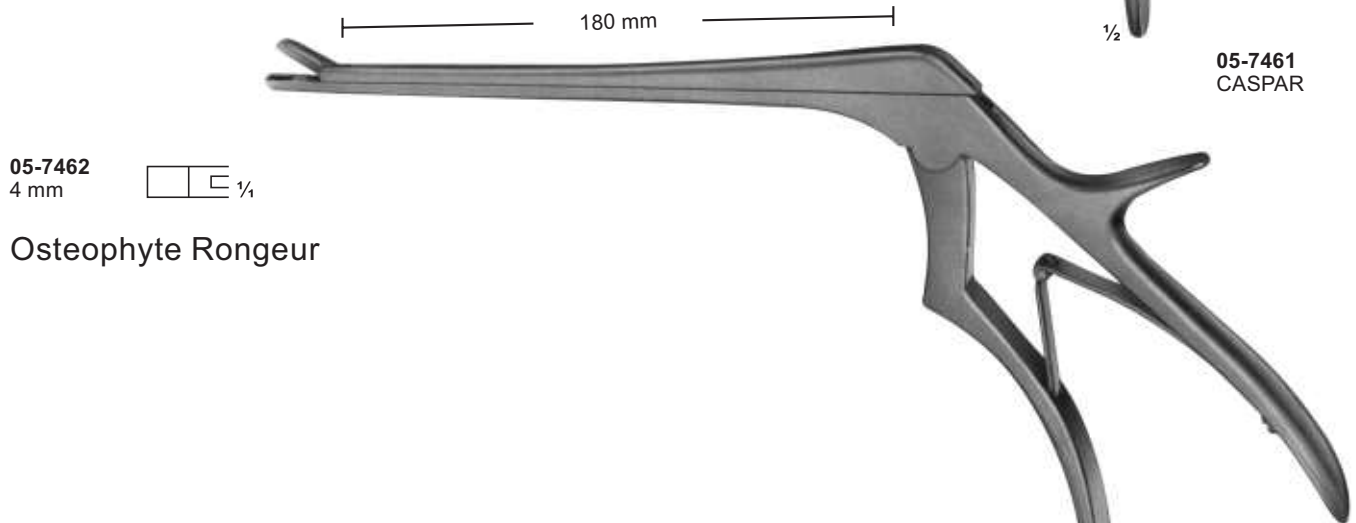
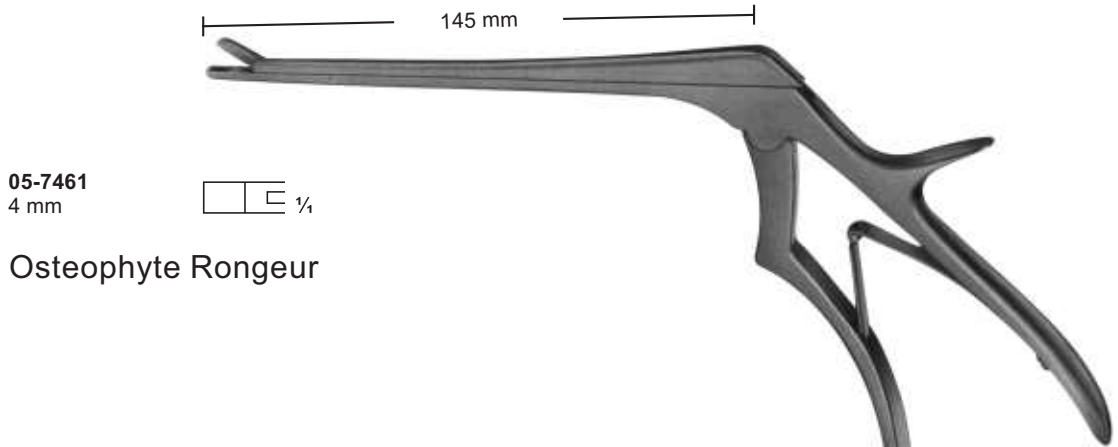

Double Cutting

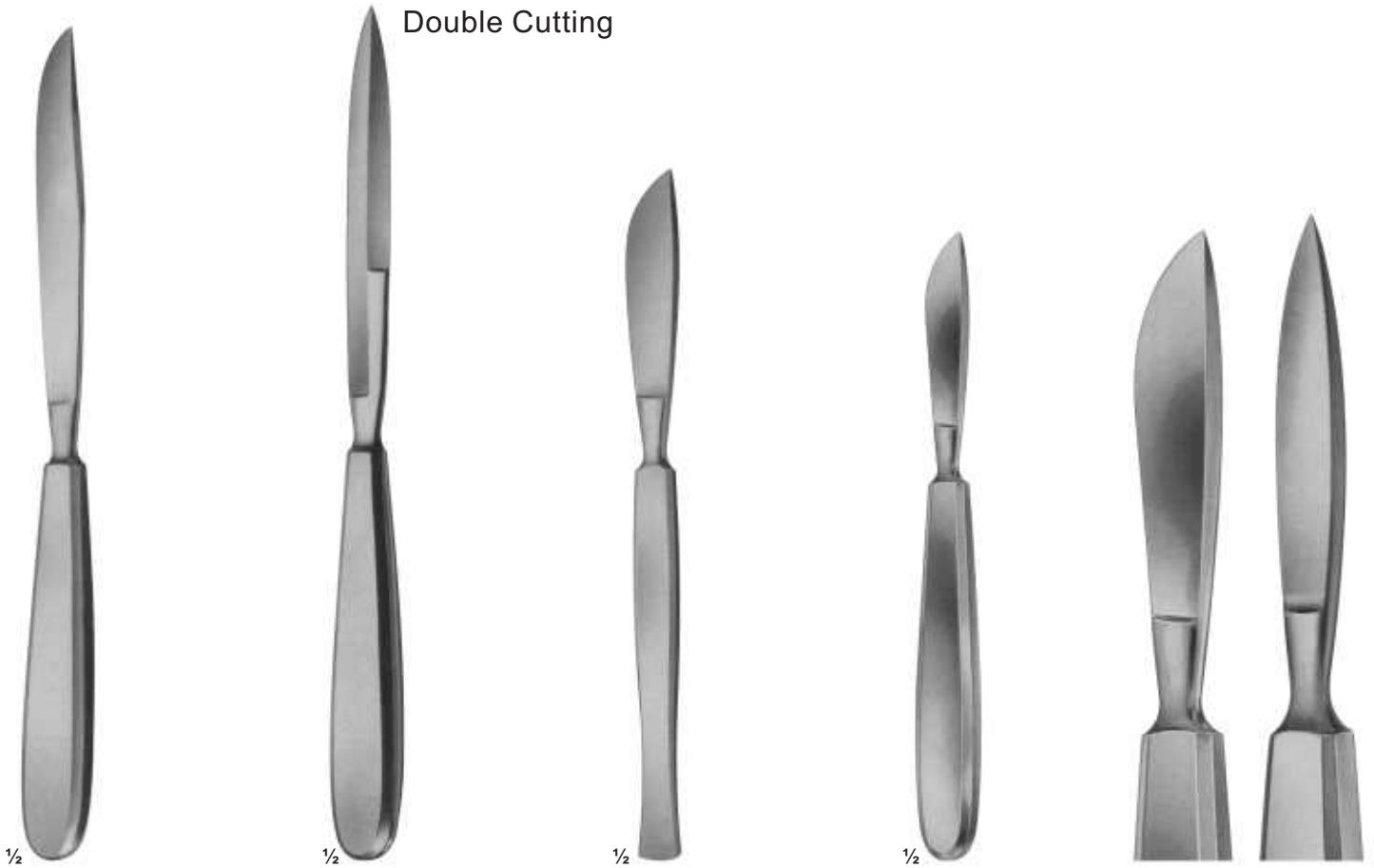

1/2
06-8001
Length of blade
Phalangeal knife
105 mm

1/2
06-8002
Length of blade
Interosseous knife
110 mm

1/2
06-8003
Length of blade
Periosteum knife
with raspator
65 mm

1/2
06-8004 - 06-8005
LANGENBECK
Length of blades
Resection knives
55 mm

06-8004 **06-8005**

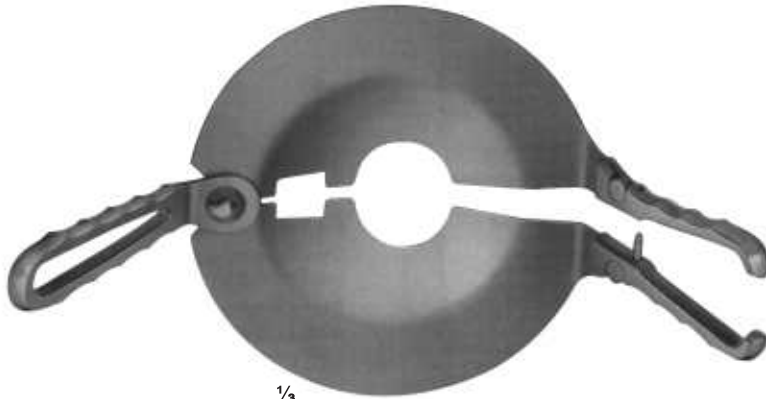

1/3

06-8006
PERCY
removeable handles

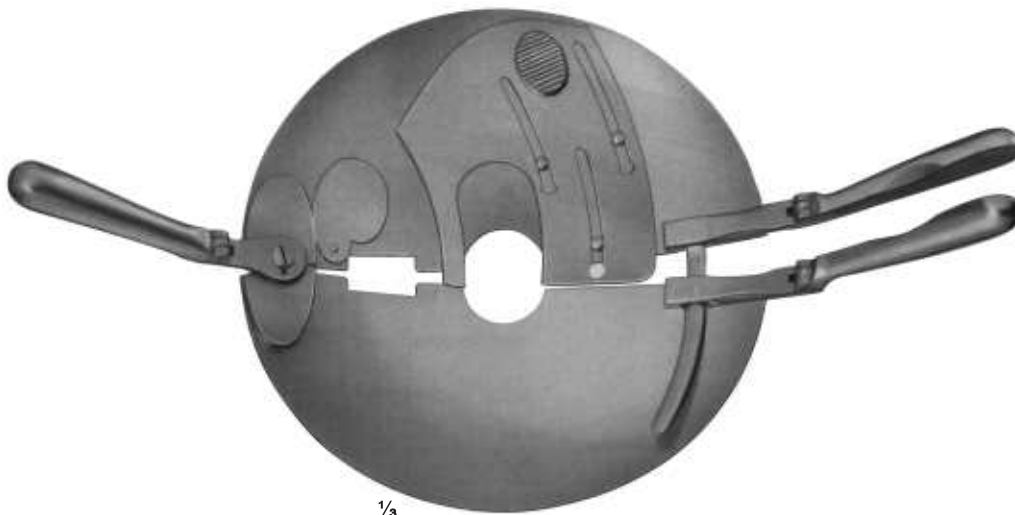

1/3

06-8007
PERCY
reversible handles

Amputation Saws



1/3

06-8008
CHARRIERE
 Length of blade
 215 mm
 complete with one saw
 blade each(**06-8009** and **06-8010**)
 350 mm

Spare saw blades, carbon steel
06-8009 12 mm
06-8010 20 mm



1/3

06-8011
RUST
 Length of blade
 235 mm
 complete with one saw
 blade each(**06-8013**, **06-8014**
 and 2 saw blades **06-8015**)
 390 mm
06-8012 Bow only

Spare saw blades, carbon steel
06-8013 6 mm
06-8014 8 mm
06-8015 12 mm
06-8016 20 mm

Amputation Saws

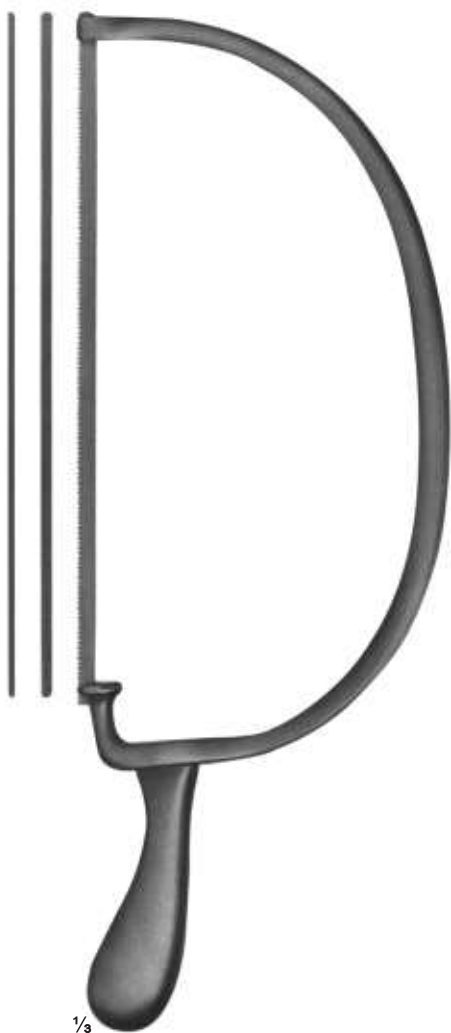

1/3

06-8017
BIER
 Length of blade
 270 mm
 complete with one saw
 blade each (**06-8018, 06-8019** and **06-8020**)
 420 mm

Spare saw blades, carbon steel
06-8018 4 mm
06-8019 6 mm
06-8020 8 mm



1/3

06-8021
CHARRIERE
 Length of blade
 180 mm
 Spare saw blade,
 carbon steel (**06-8022**)
 270 mm

06-8023
CHARRIERE
 Length of blade
 240 mm
 Spare saw blade,
 carbon steel (**06-8024**)
 340 mm



1/3

06-8025
SATTERLEE
 Length of blade
 200 mm
 Spare saw blade,
 carbon steel (**06-8026**)
 200 mm



1/3

06-8027
LANGENBECK
 Length of blade
 115 mm
 Metacarpal saw
 235 mm



06-8028 - 06-8031
OLIVECRONA
06-8028 300 mm
06-8029 400 mm
06-8030 500 mm
06-8031 700 mm



06-8032 - 06-8035
GIGLI
06-8032 300 mm
06-8033 400 mm
06-8034 500 mm
 fine, 6 wires twisted
06-8035 500mm
 coarse, 4 wires twisted



06-8036
GIGLI
 Handle



06-8037
LEBSCHE
 Conductor for
 wire saws, malleable
 250 mm

Elevators and Bone Levers

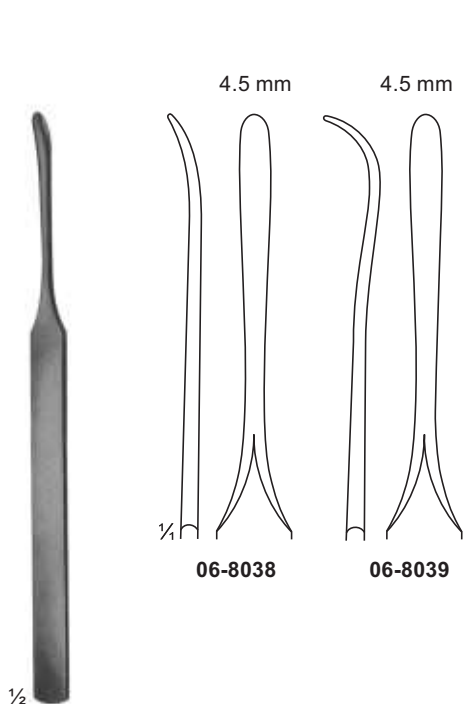

06-8038 - 06-8039
KOENIG
 155 mm

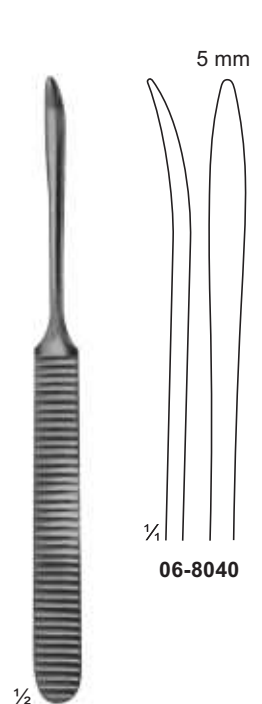

06-8040
WILLIGER
 165 mm

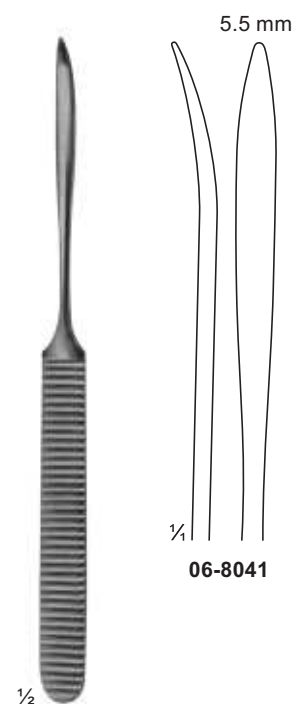

06-8041
WILLIGER
 170 mm

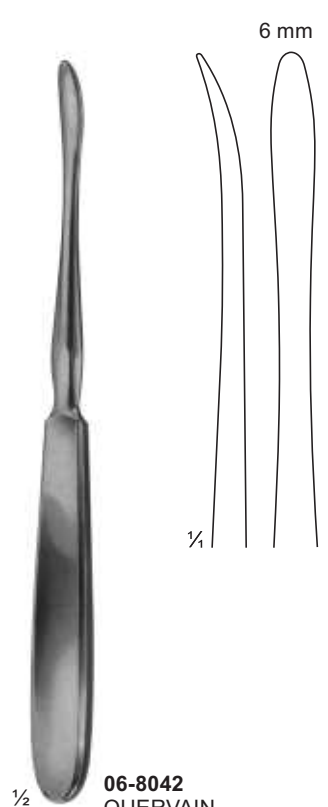

06-8042
QUERVAIN
 195 mm

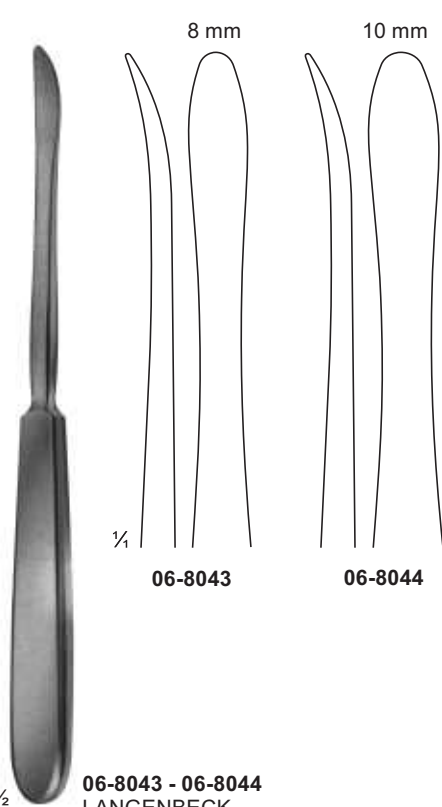

06-8043 - 06-8044
LANGENBECK
 195 mm

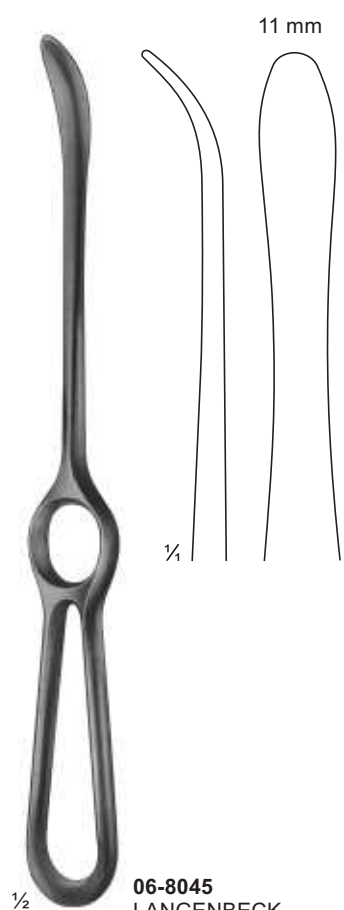

06-8045
LANGENBECK
 230mm

Bone Levers

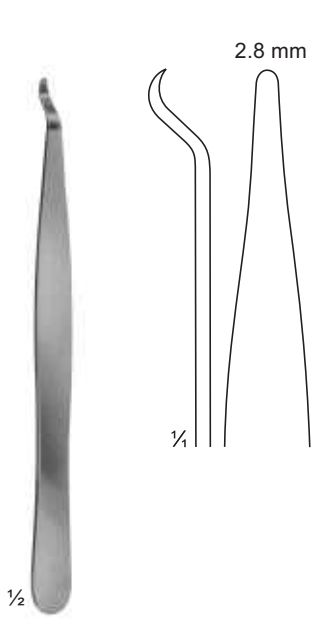

06-8046
140mm

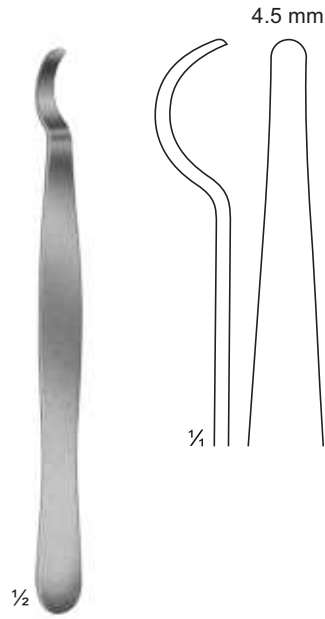

06-8047
150mm

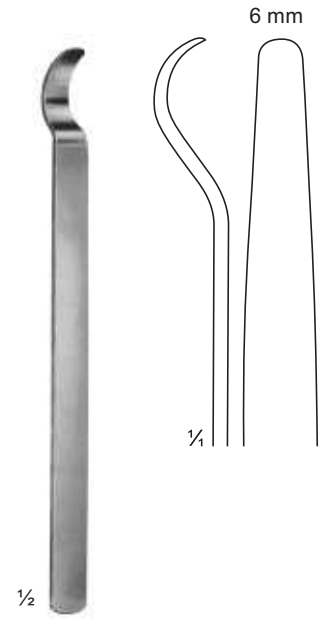

06-8048
150mm

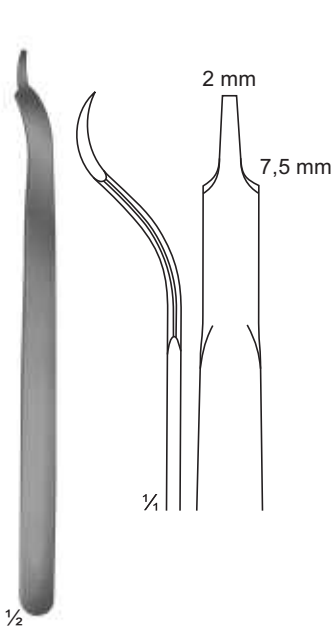

06-8049
BUCK-GRAMCKO
150mm

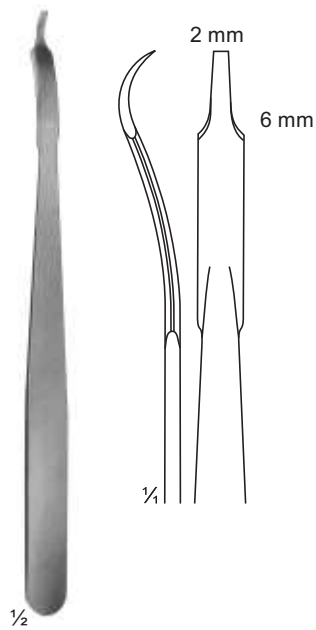

06-8050
160mm

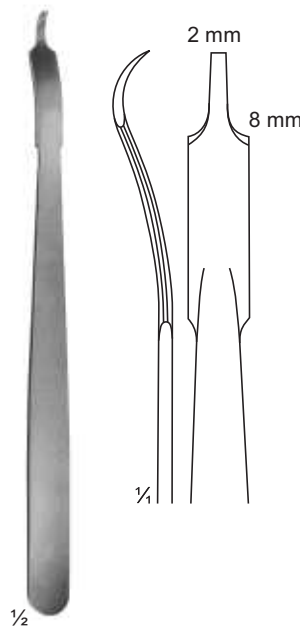

06-8051
160mm

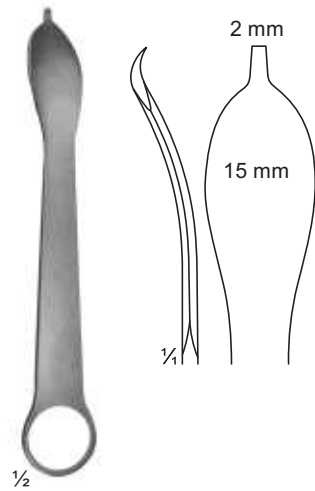

06-8052
125mm

Bone Levers

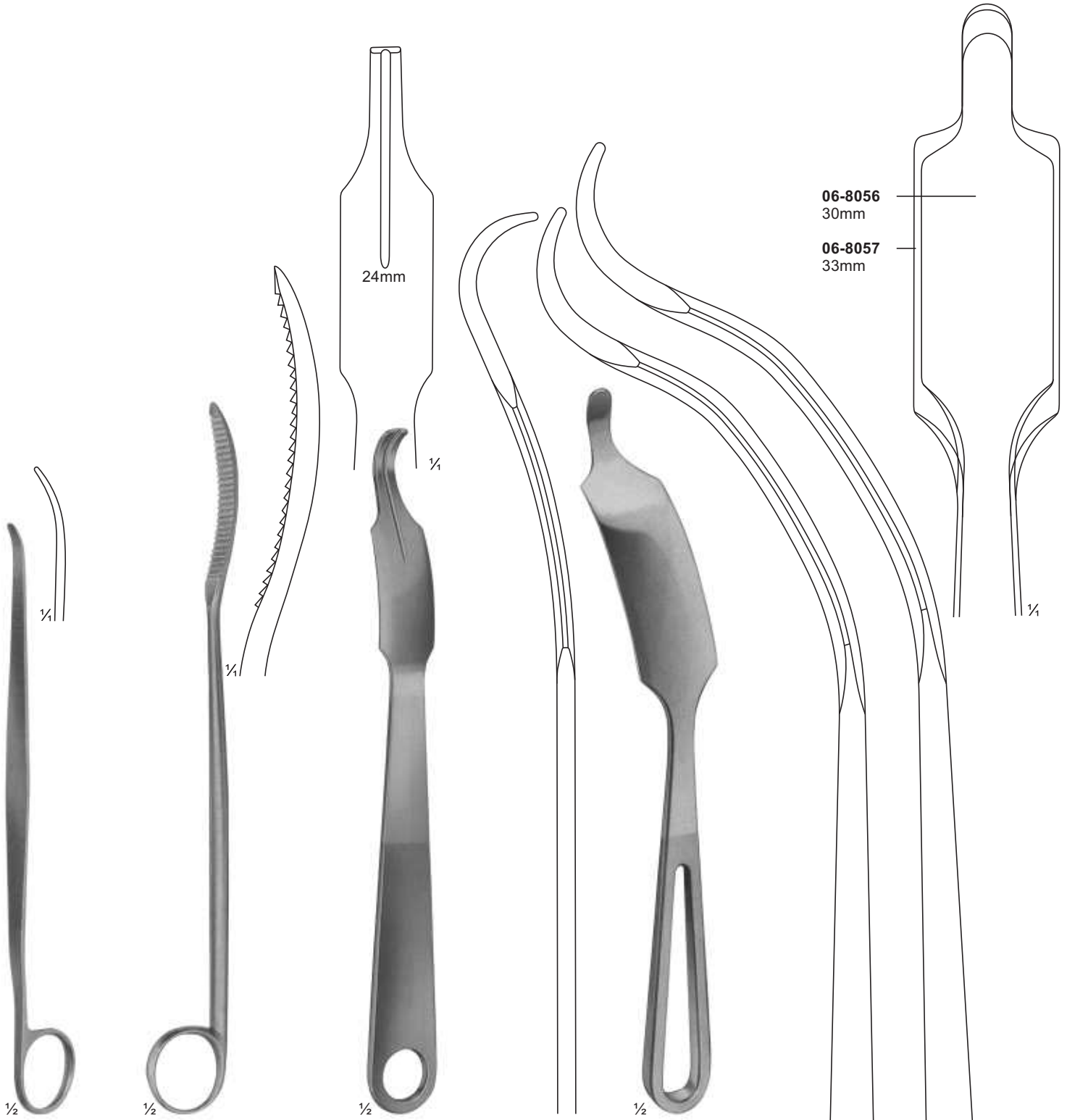

06-8053
LANE TRETHOWAN
215mm

06-8054
LANE
255mm

06-8055
LANGE-HOHMANN
250mm

06-8056 - 06-8057
LANGE-HOHMANN
modif
06-8056 265mm
06-8057 280mm

Bone Levers

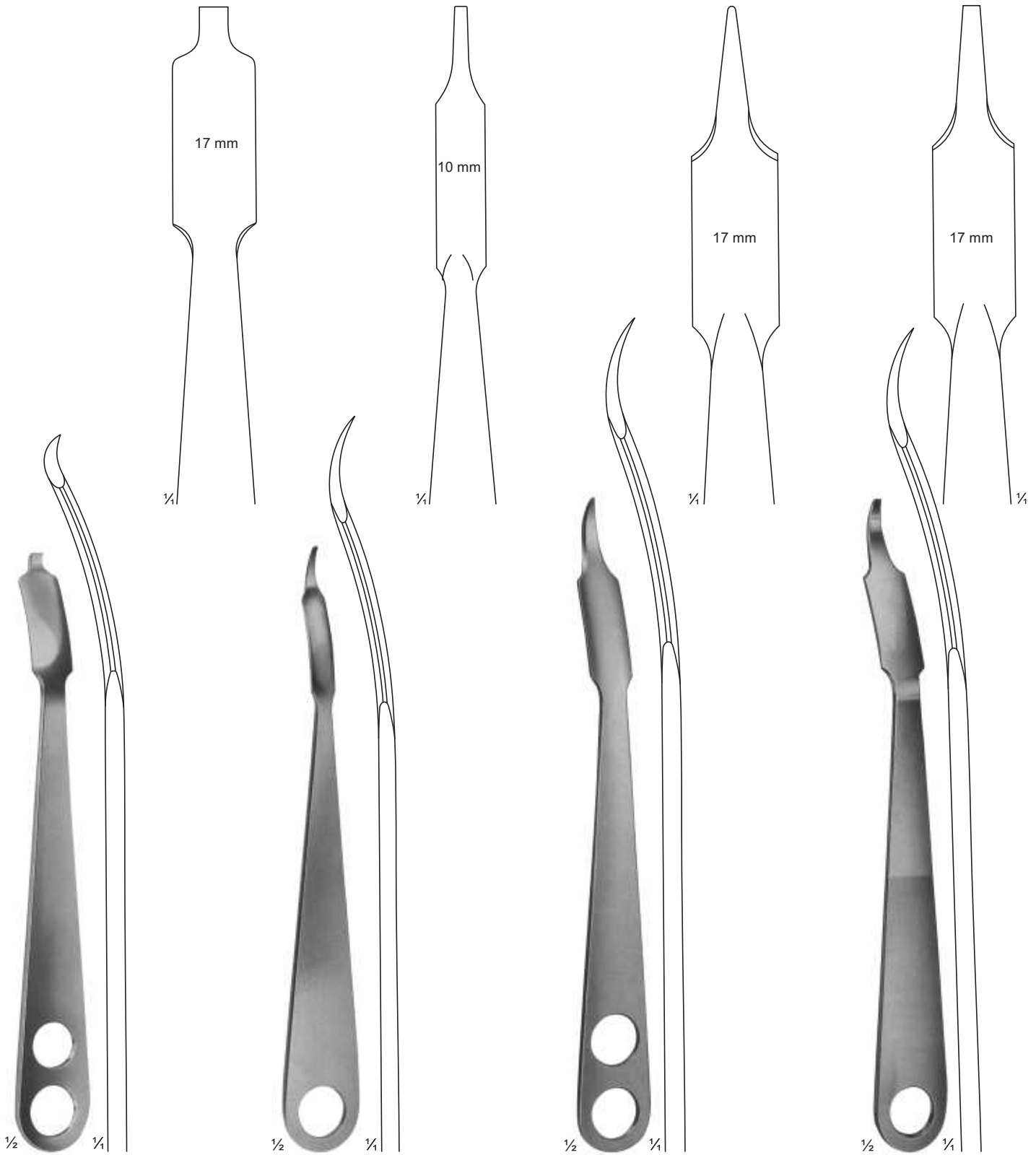

06-8058
WAGNER
220 mm

06-8059
220 mm

06-8060
240 mm

06-8061
240 mm

Bone Levers

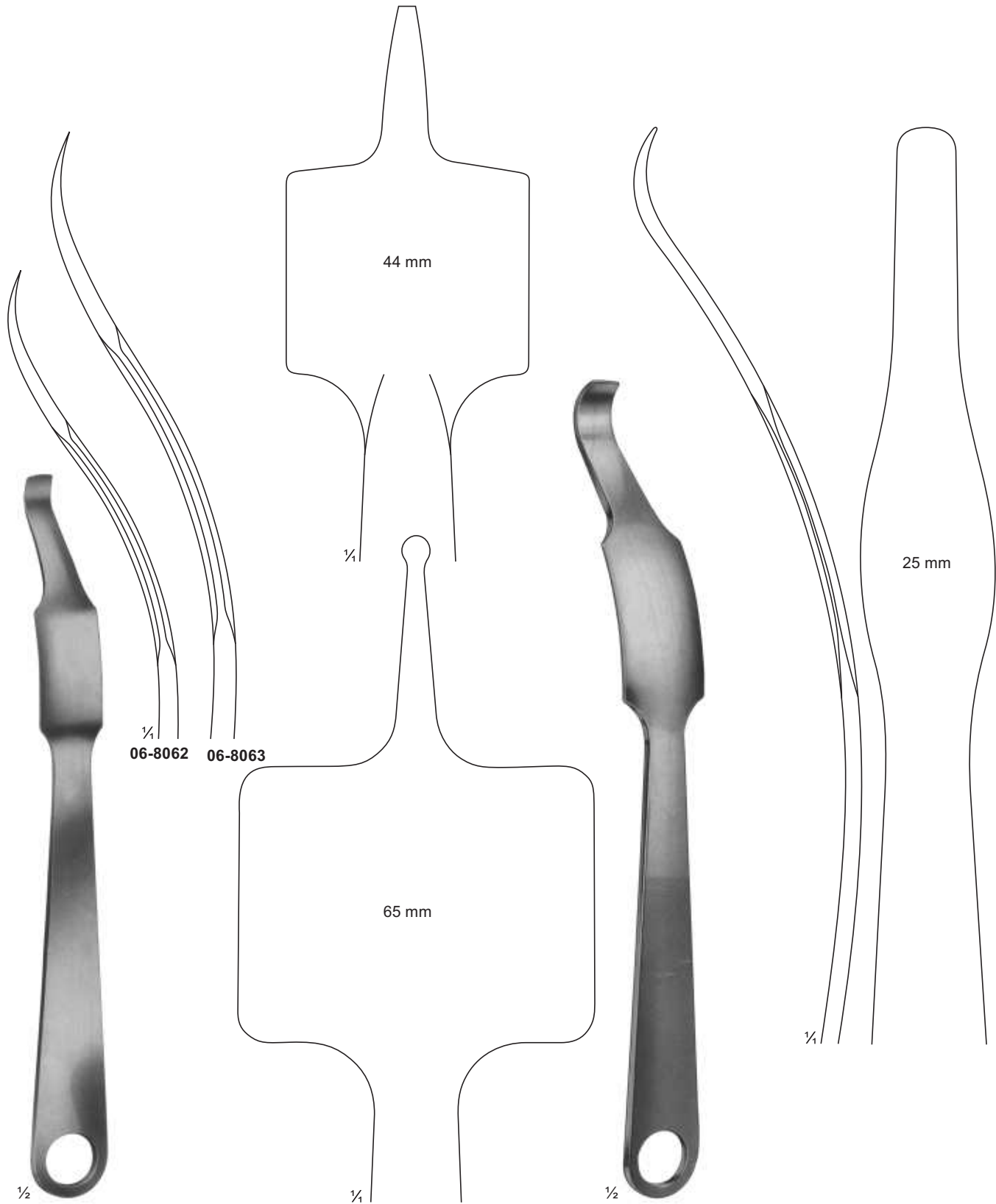

06-8062 - 06-8063
VERBRUGGE-MULLER
06-8062 240 mm
06-8063 255 mm

06-8064
260 mm

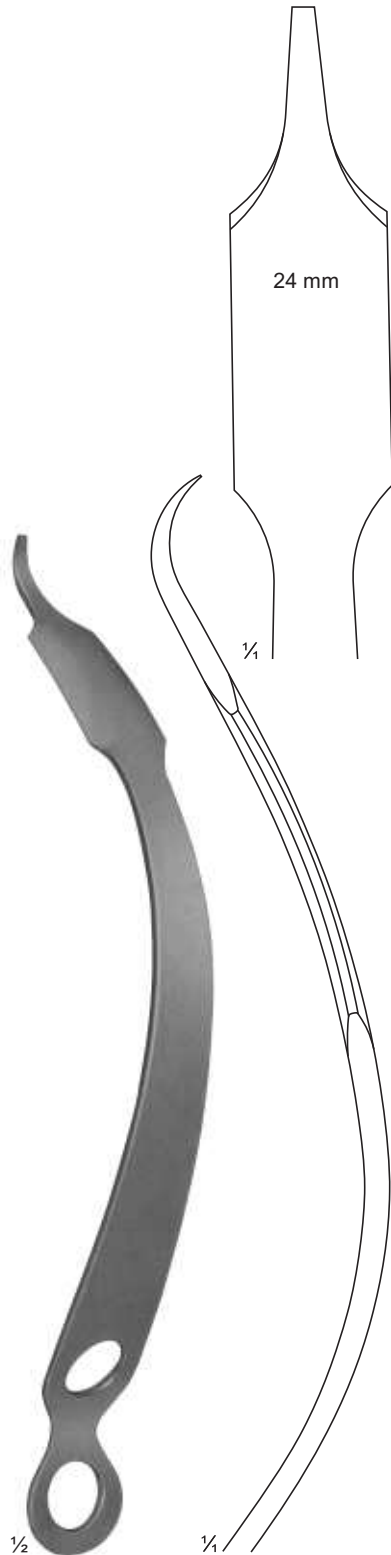

06-8065
HOHMANN-ALDINGER
270 mm

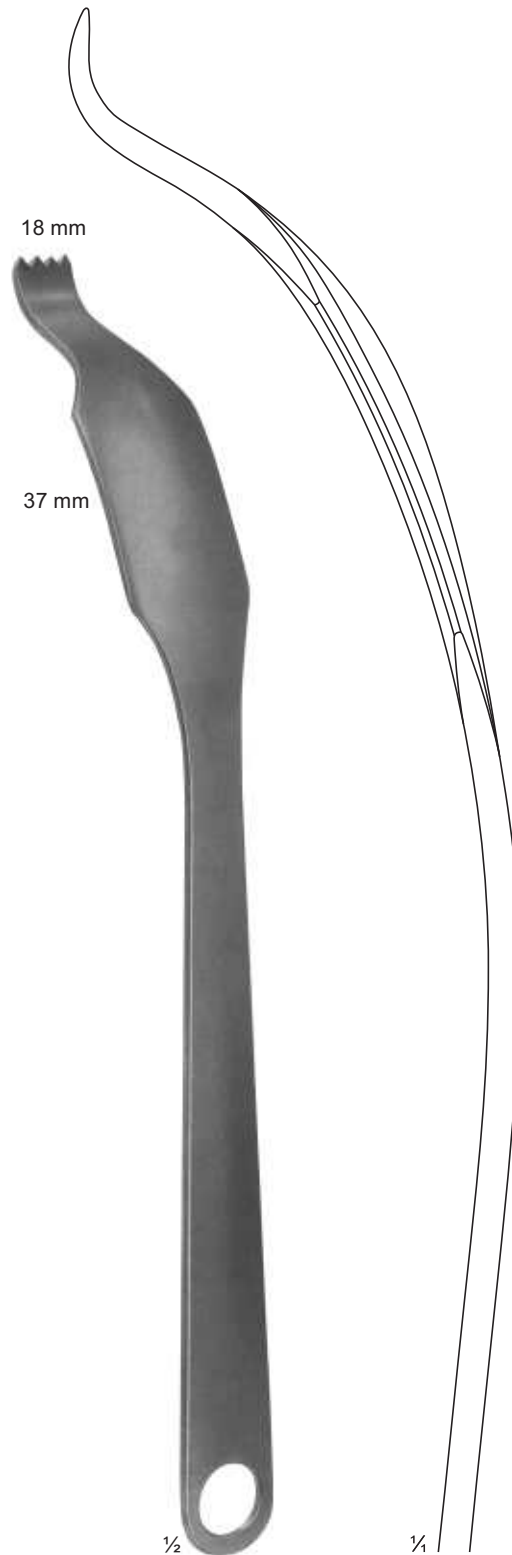

06-8066
SCHUMACHER mod. WAGNER
345 mm

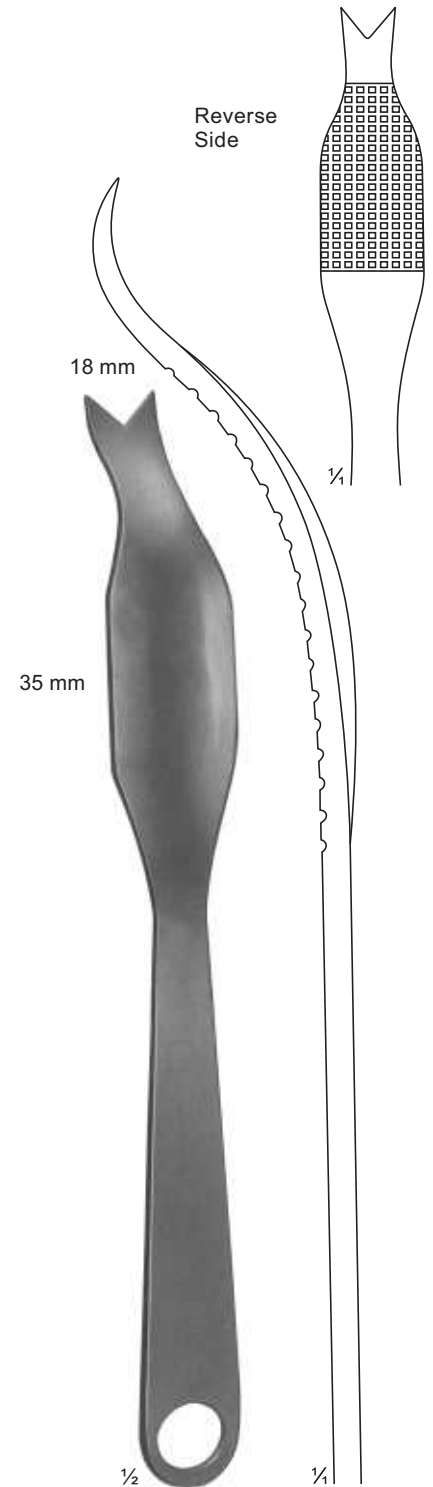

06-8067
SCHUMACHER
290 mm

Special Bone Levers

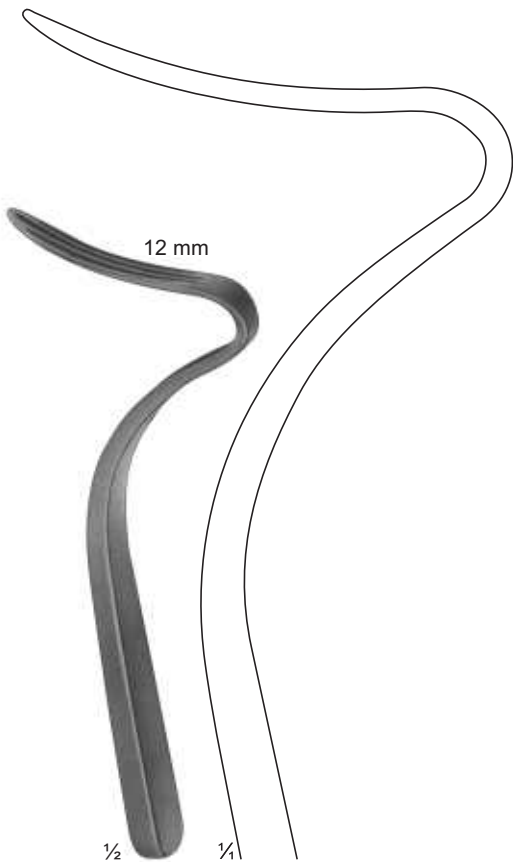

06-8068
TAGER
 Bone lever for
 angle joint operations
 175 mm

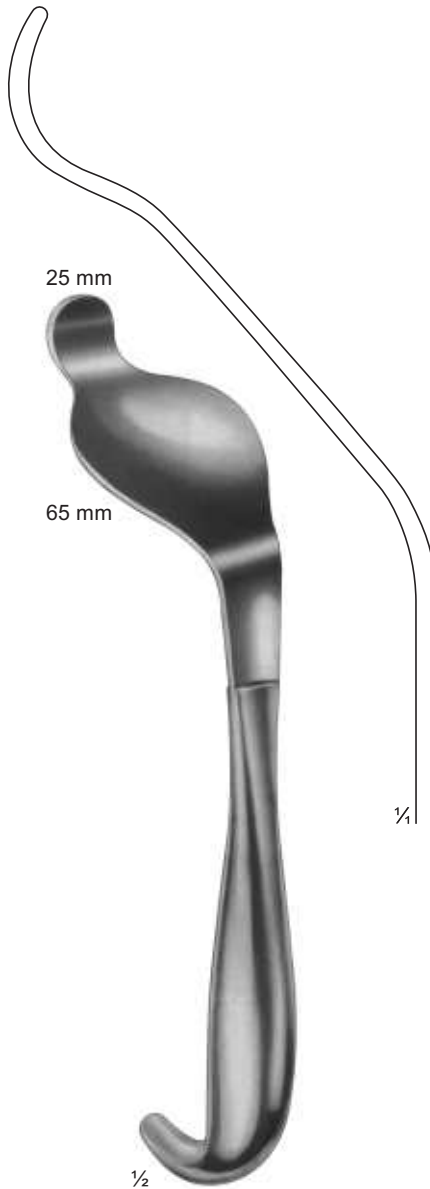

06-8069
BENNETT
 235 mm

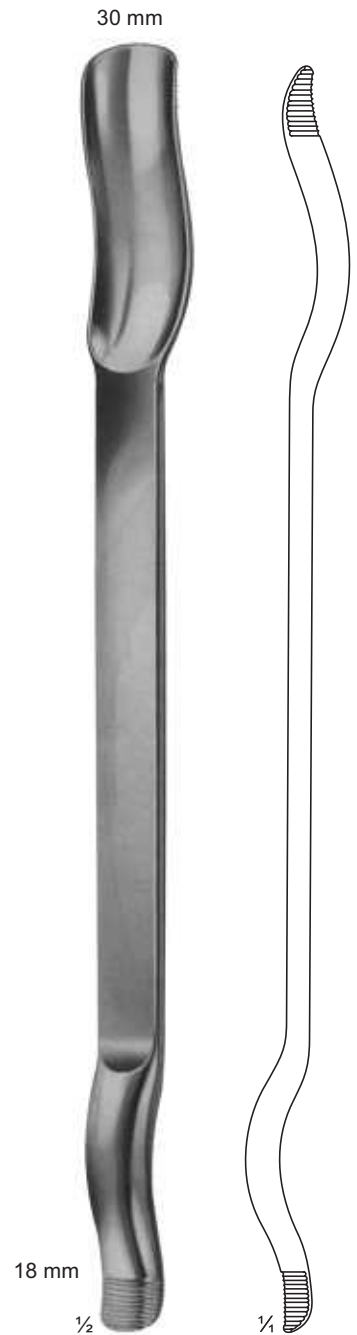

06-8070
MURPHY-LANE
 Luxation lever
 340 mm

Raspatories

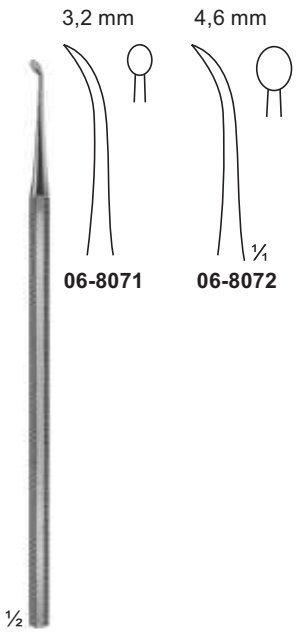

06-8071 - 06-8072
PARTSCH
150 mm

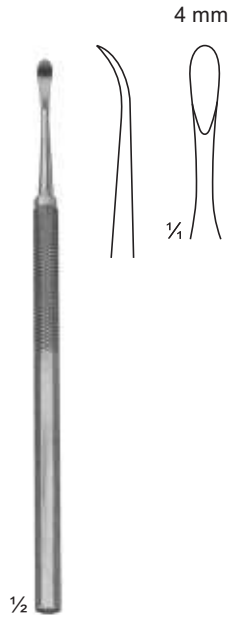

06-8073
PARTSCH mod. LANGE
145 mm

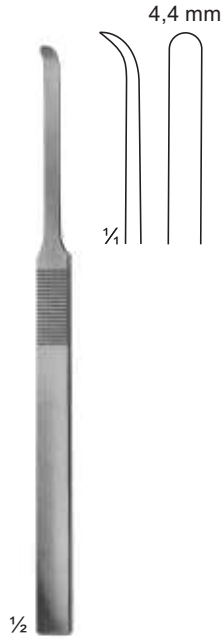

06-8074
MC KENTY
155 mm

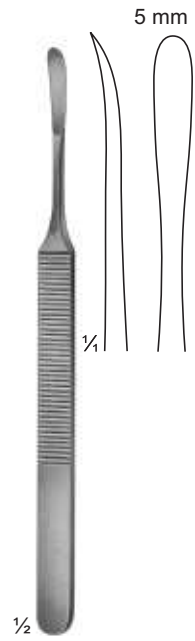

06-8075
KOENIG
155 mm

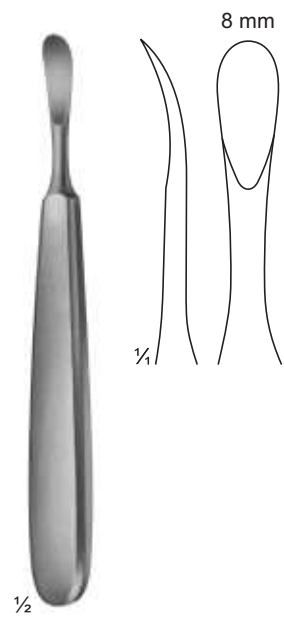

06-8076
TRELAT
150 mm

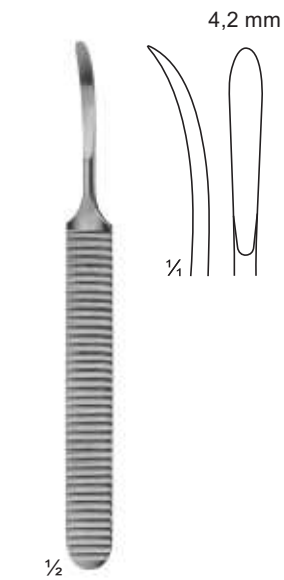

06-8077
WILLIGER
140 mm

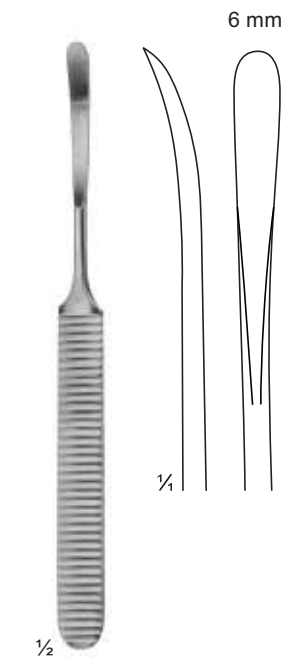

06-8078
WILLIGER
160 mm

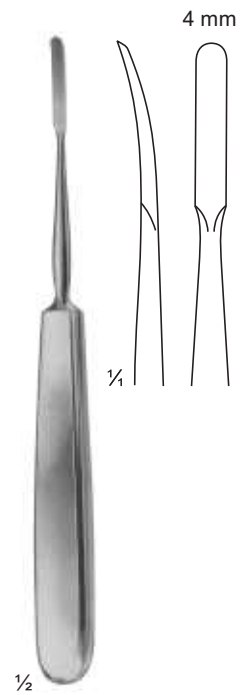

06-8079
JOSEPH
170 mm

Raspatories

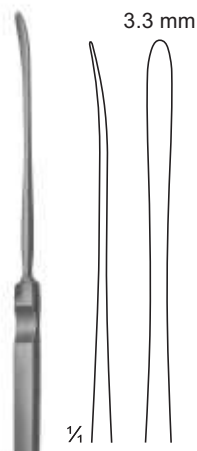

1/2
06-8080
HALLE
blunt
180 mm

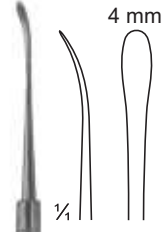

1/2
06-8081
FREER
blunt
190 mm



1/2
06-8082
FREER
sharp
190 mm

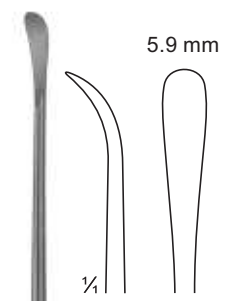

1/2
06-8083
SEWALL
blunt
200 mm

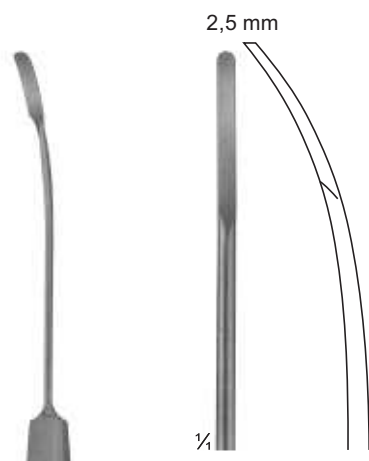

06-8084

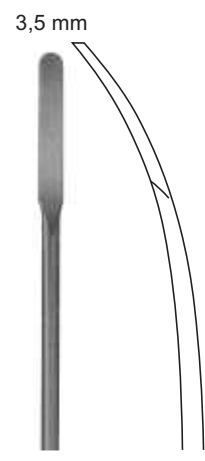

06-8085

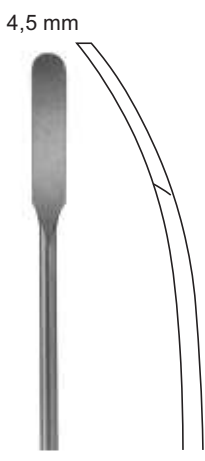

06-8086

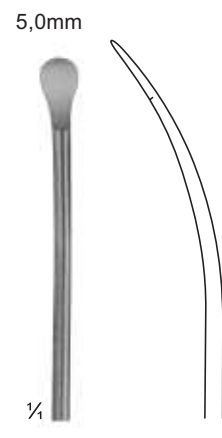

06-8087

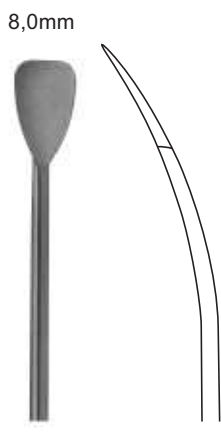

06-8088

1/2
06-8084 - 06-8086
PAULSEN
205 mm

1/2
06-8087 - 06-8088
PAULSEN
205 mm

Raspatories

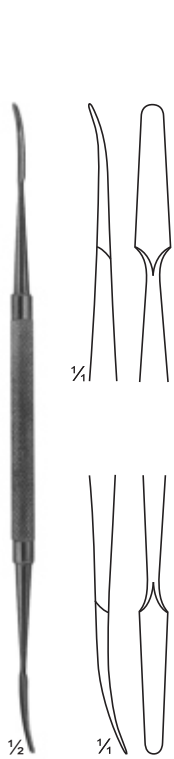

06-8089
KILLIAN
sharp/blunt
185 mm

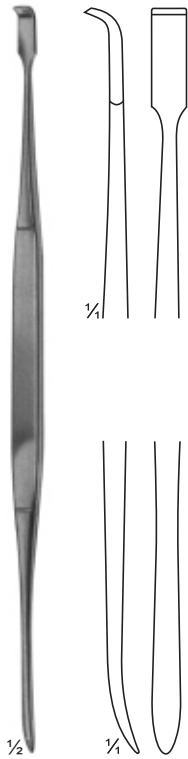

06-8090
HOWARTH
sharp/blunt
215 mm

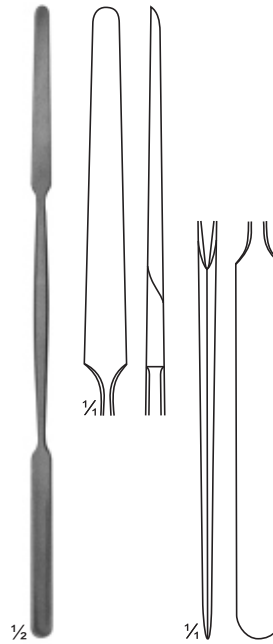

06-8091
KILLIAN
sharp/blunt
185 mm

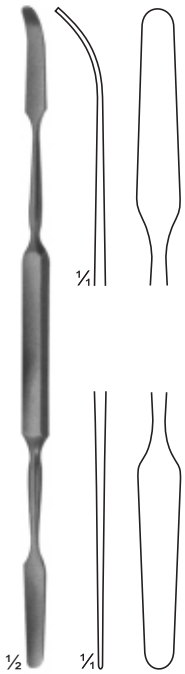

06-8092
MAC DONALD
blunt/blunt
185 mm

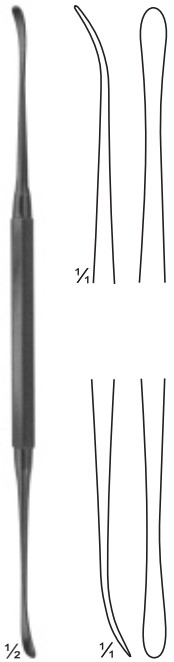

06-8093
FREER
sharp/blunt
185 mm

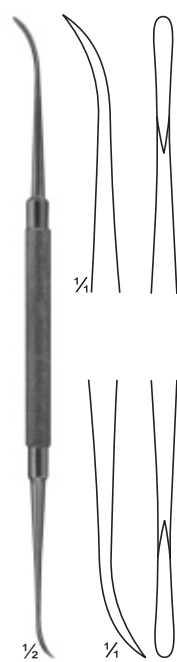

06-8094
FREER-YASARGIL
sharp/sharp
185 mm

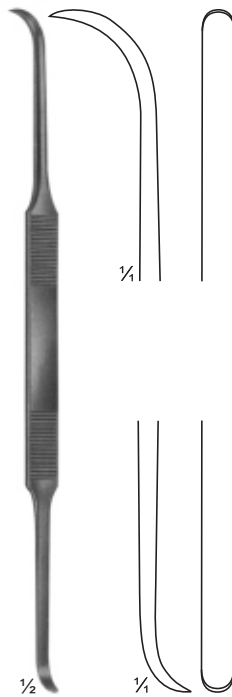

06-8095
COTTLE
sharp/sharp
200 mm

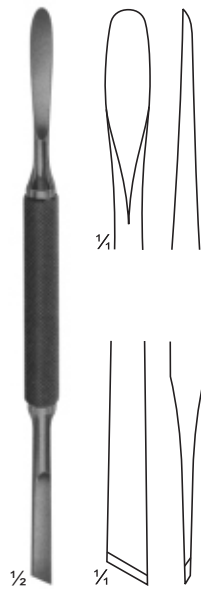

06-8096
MEAD
sharp/sharp
165 mm

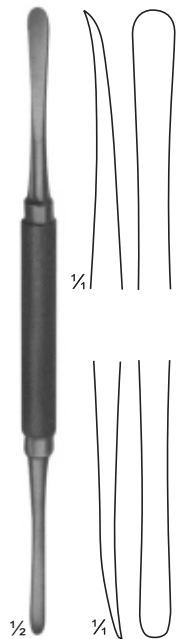

06-8097
MOLT
sharp/sharp
180 mm

Raspatories

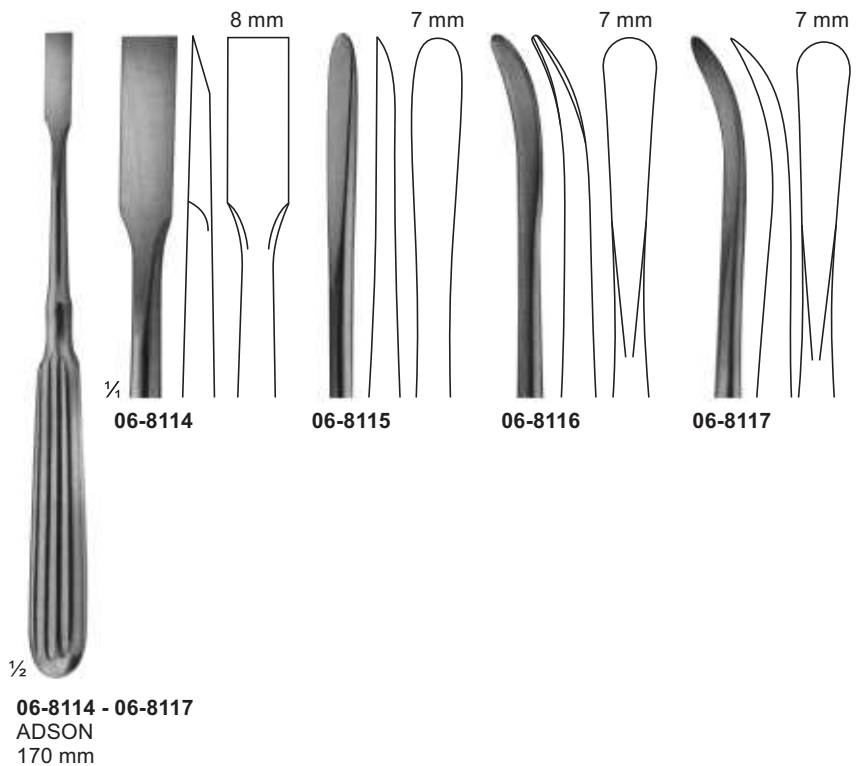
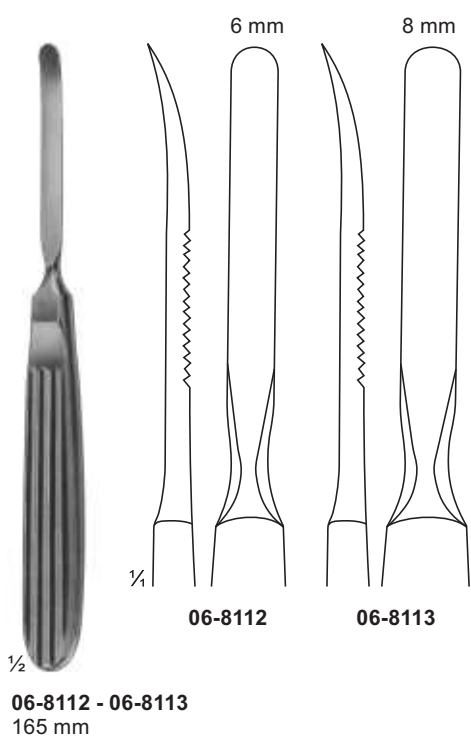
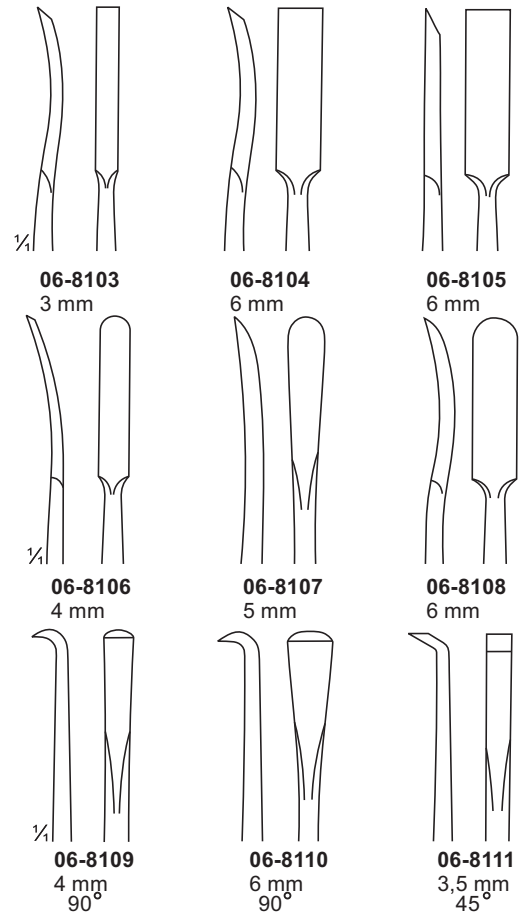
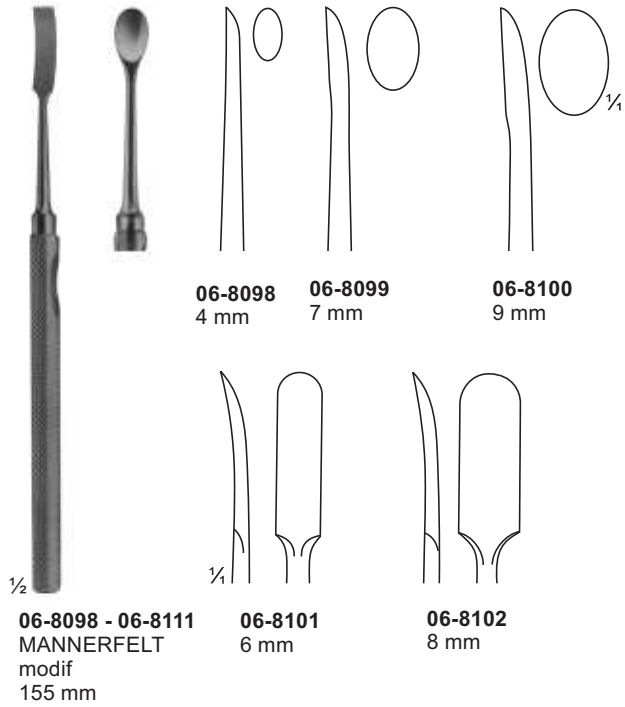

Raspatories

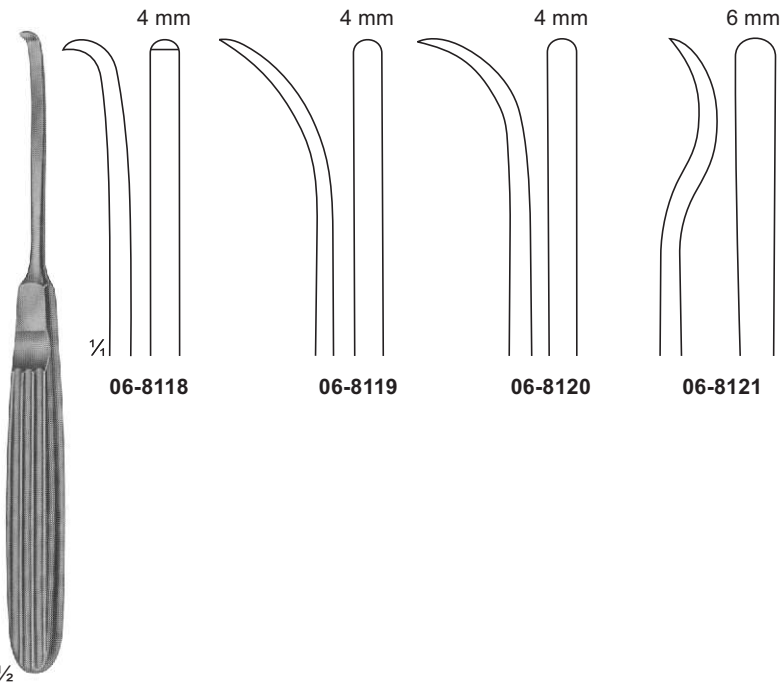

06-8118

06-8119

06-8120

06-8121

06-8118 - 06-8121
MUEHLING
170 mm

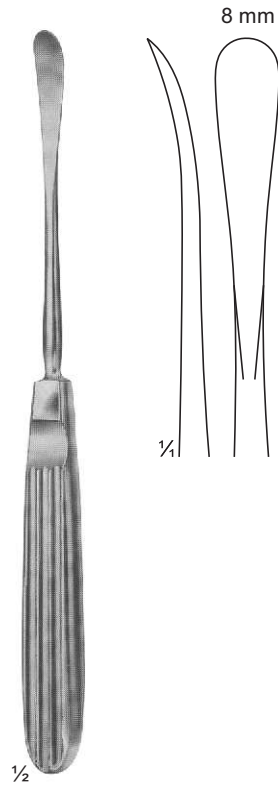

06-8122
COTTLE
195 mm

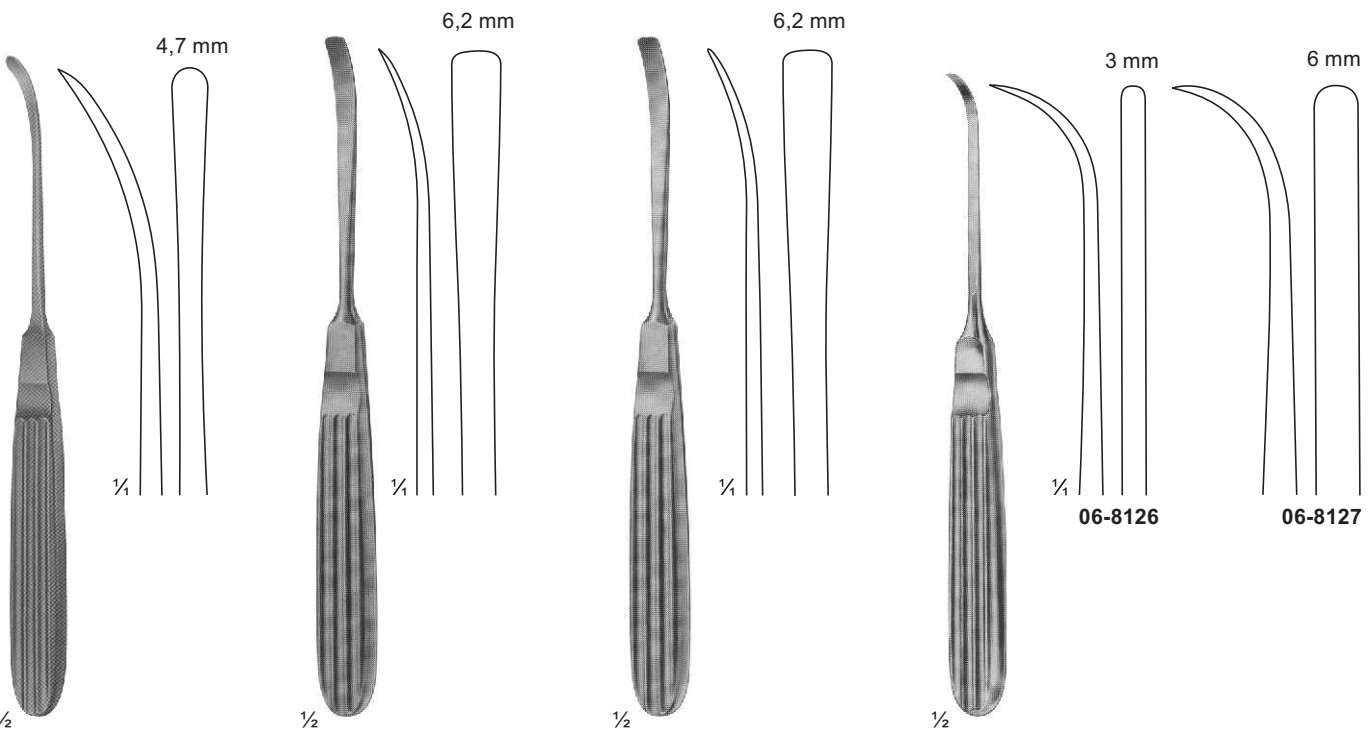

06-8123
LANDOLT
175 mm

06-8124
CASPAR
180 mm

06-8125
CASPAR
180 mm

06-8126 - 06-8127
170 mm

Raspatories

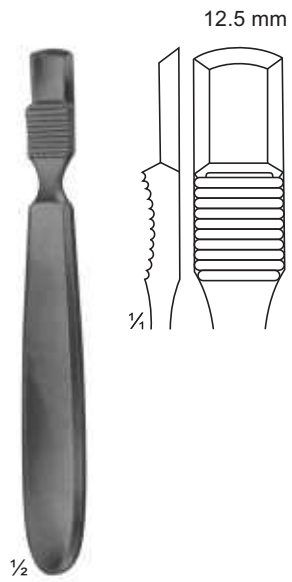

06-8128
FARABEU
140 mm

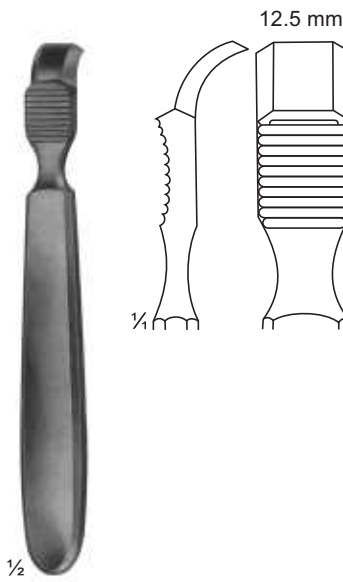

06-8129
FARABEU
140 mm

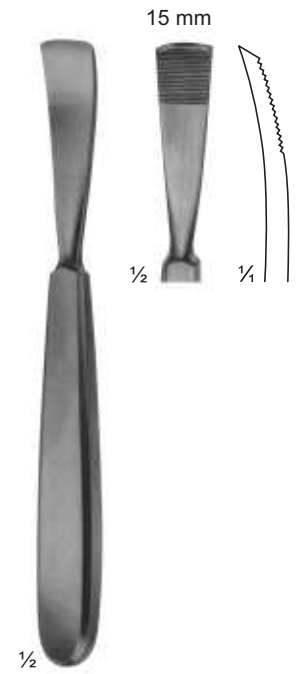

06-8130
JANSEN
165 mm

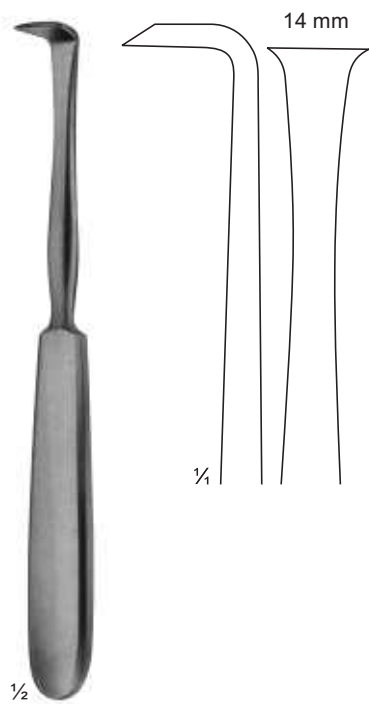

06-8131
LANGENBECK
180 mm

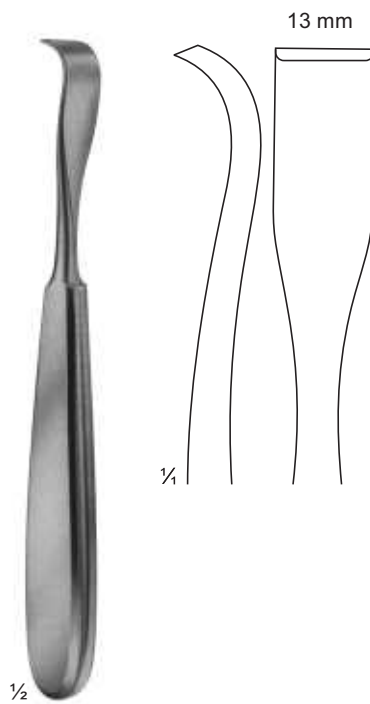

06-8132
SCHNEIDER
175 mm

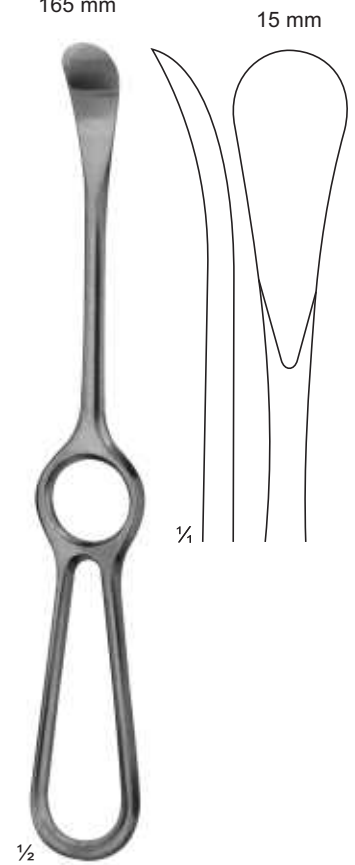

06-8133
SEDILLOT
215 mm

Raspatories

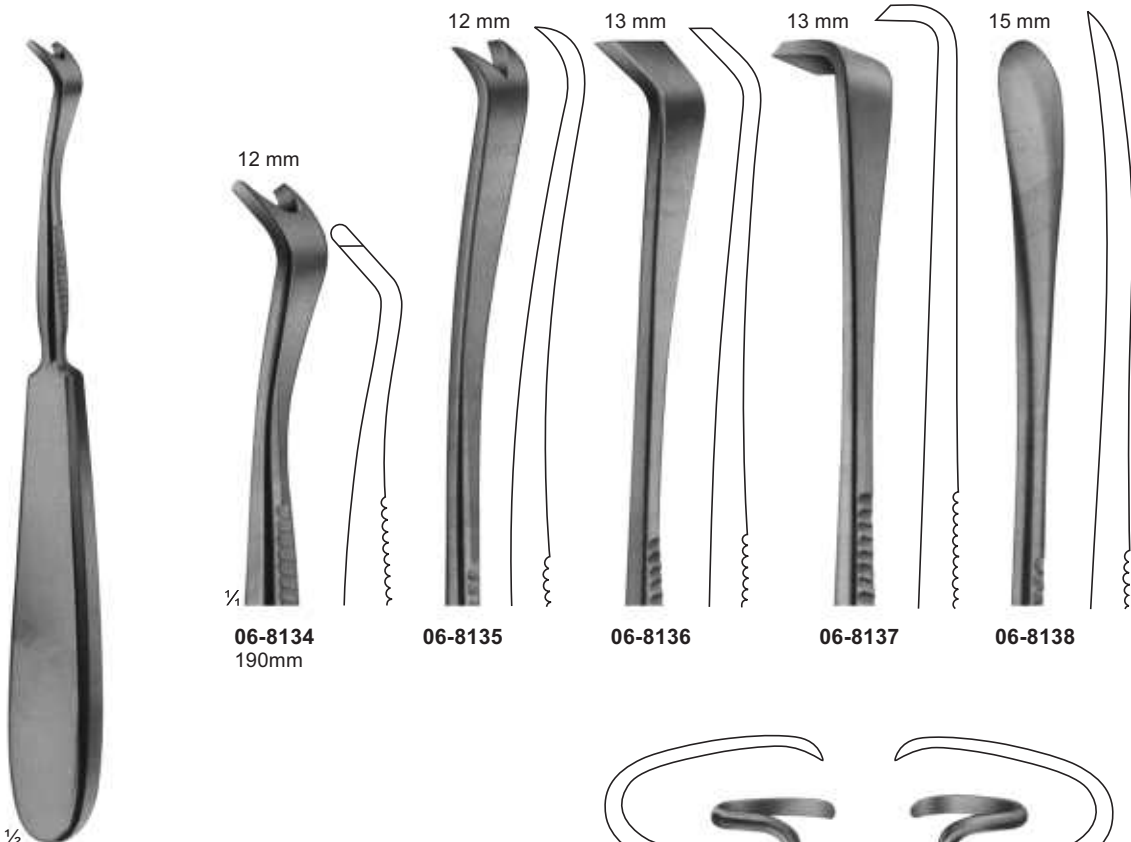

06-8134 - 06-8138
SEMB
230 mm



06-8143

06-8144

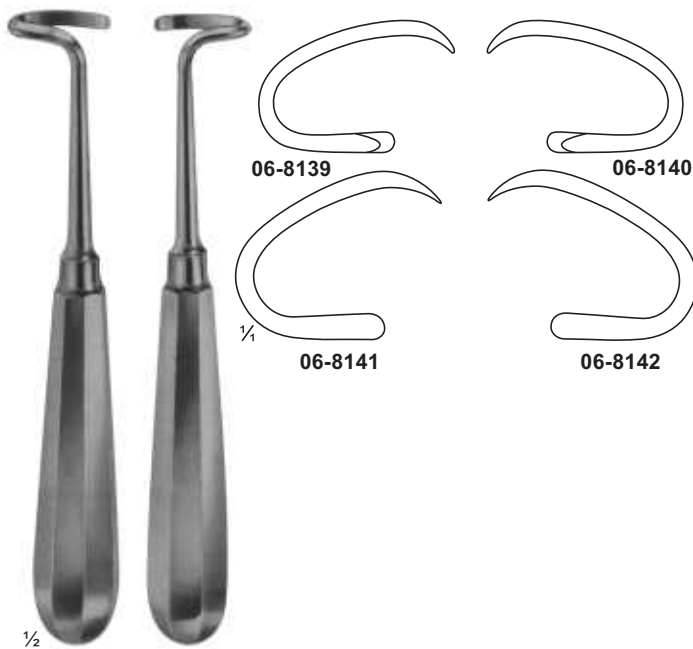

06-8139 - 06-8140
DOYEN for children
06-8141 - 06-8142
for adults 175 mm

06-8143 - 06-8144
DOYEN
240 mm

Raspatories with HARTPRESS-handle

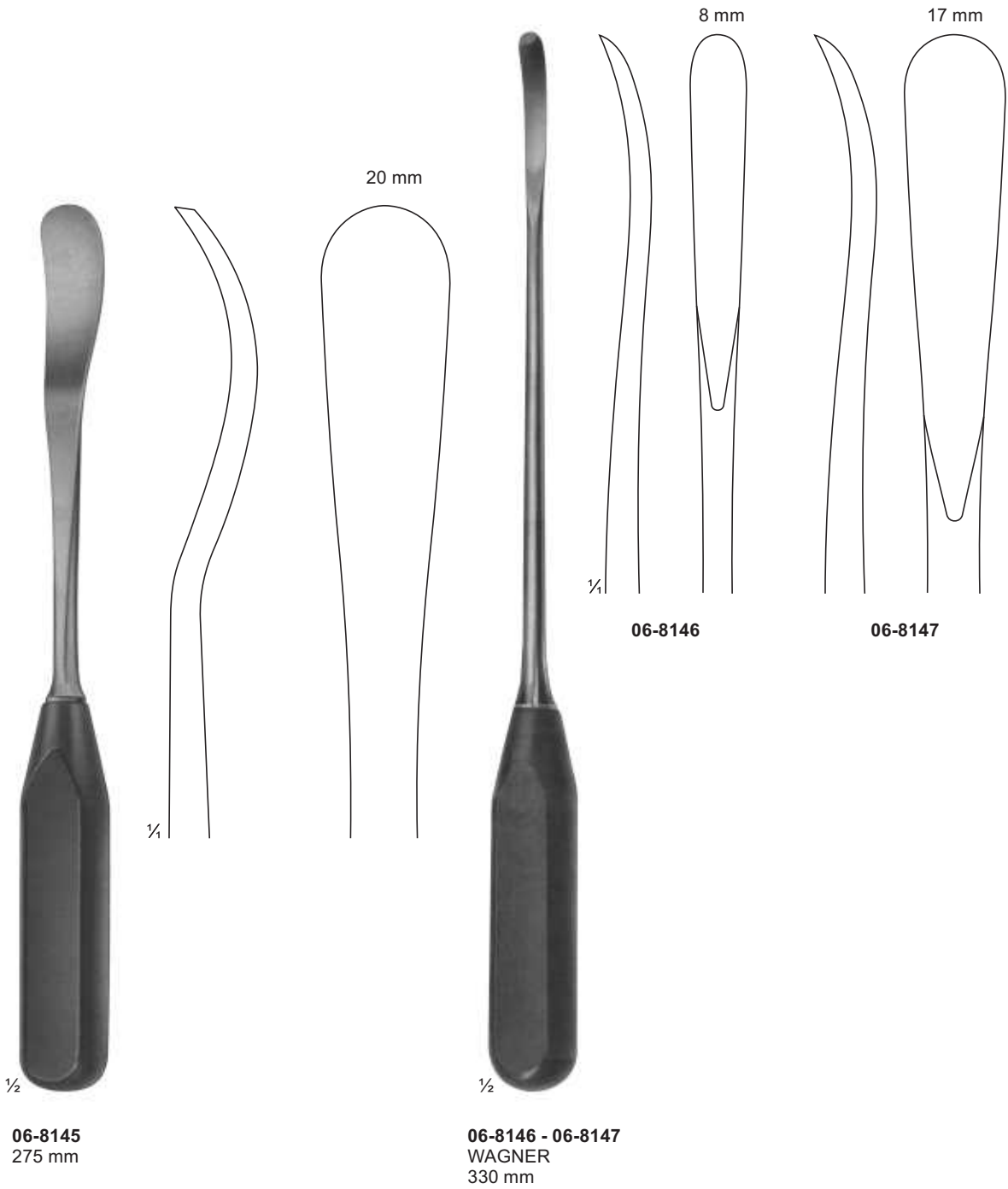

Bone File and Rasps

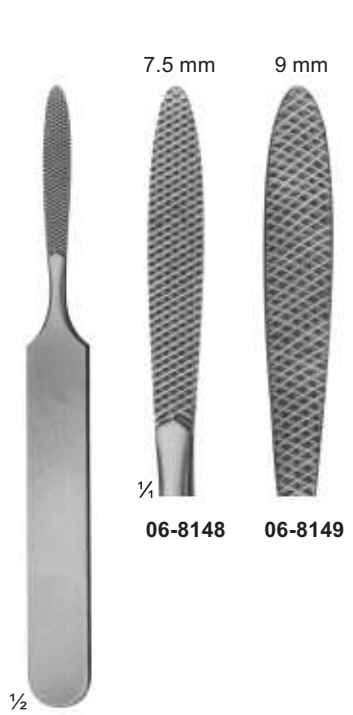

06-8148
JOSEPH
fine, chequered

06-8149
coarse, chequered
165 mm



06-8152
MALTZ
down stroke
180 mm



06-8153
AUFRICHT
up stroke
06-8154
down stroke
220 mm

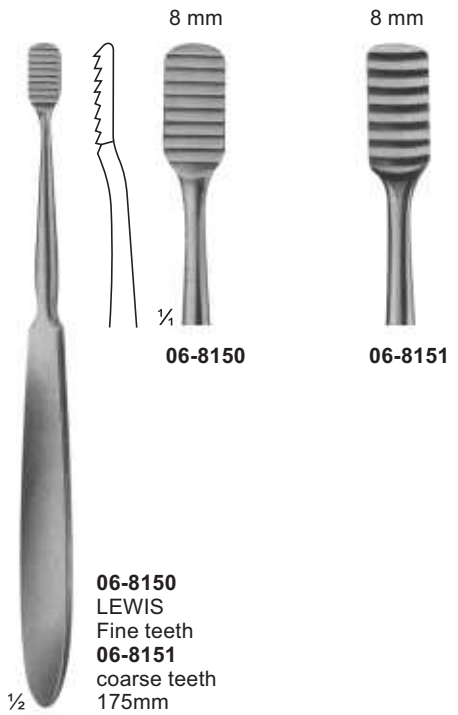
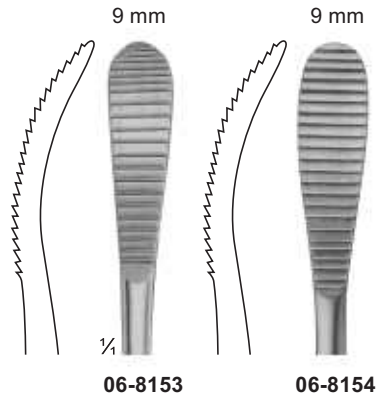

06-8150
LEWIS
Fine teeth
06-8151
coarse teeth
175mm



06-8155
GALLAHER
190 mm

Bone File and Rasps, Durogrip Rasps

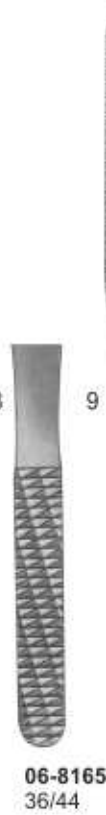
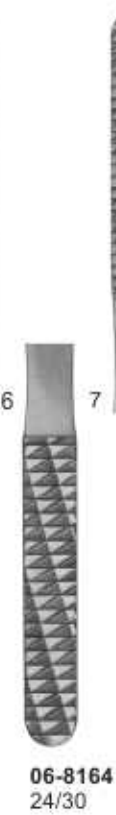
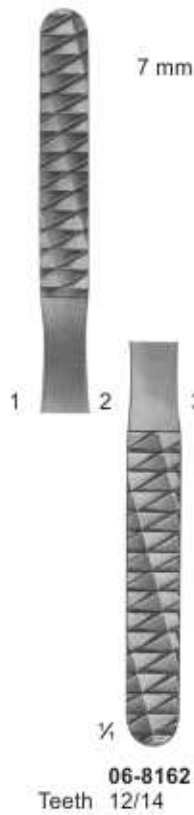
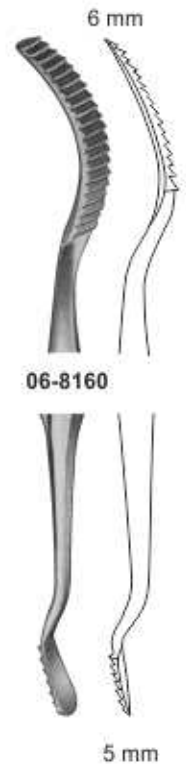

Bone File and Rasps

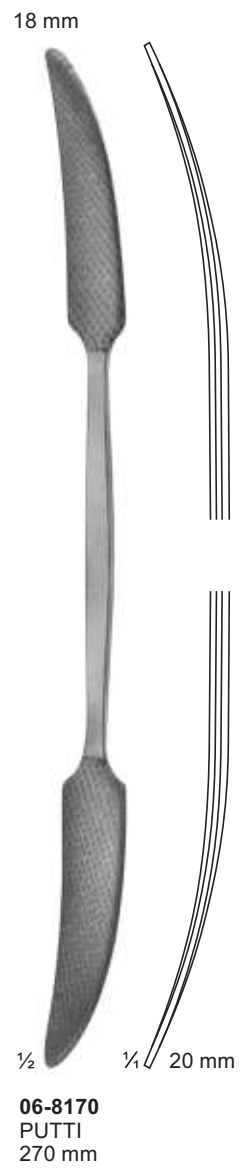
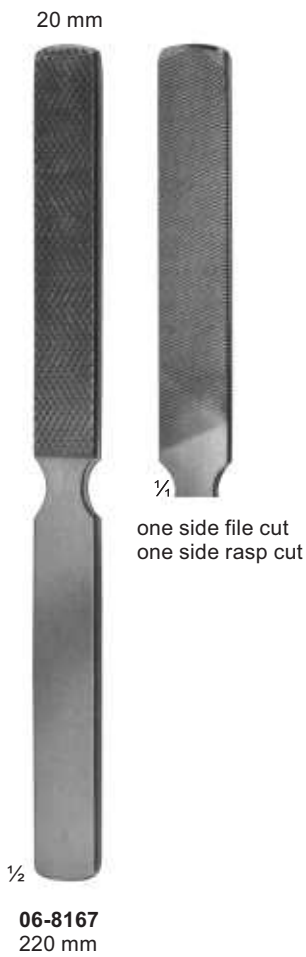

Bone Curettes

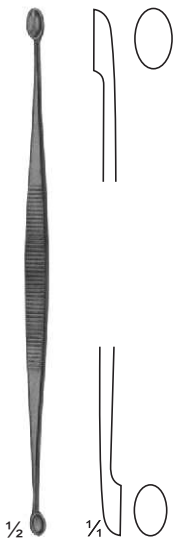

06-8171
JACOBSON
140 mm

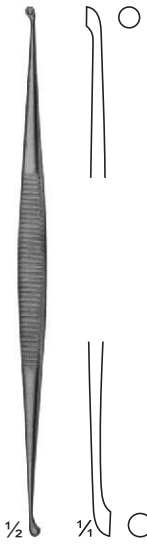

06-8172
MARTINI
140 mm

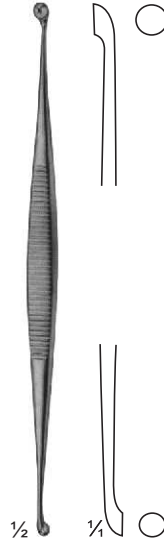

06-8173
MARTINI
140 mm



06-8174
WILLIGER
145 mm



06-8175
JANSEN
160 mm



06-8176
BARTH
180 mm

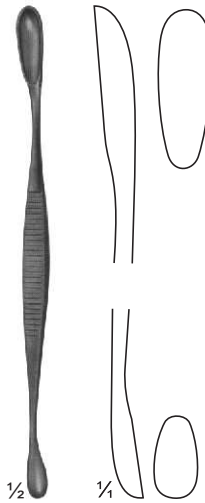

06-8177
VOLKMANN
130 mm

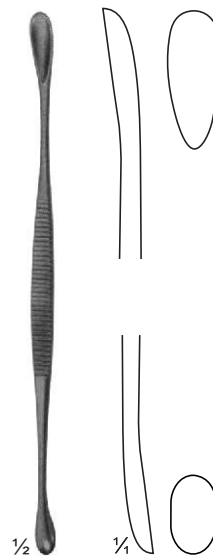

06-8178
VOLKMANN
145 mm

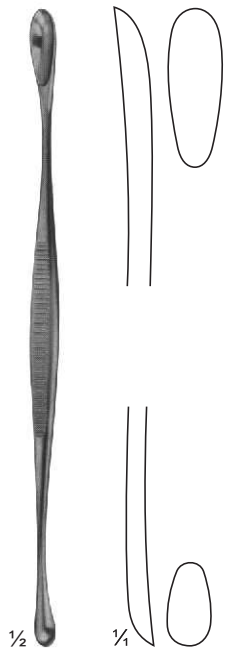

06-8179
VOLKMANN
170 mm

Bone Currettes



06-8180
JANSEN
160 mm

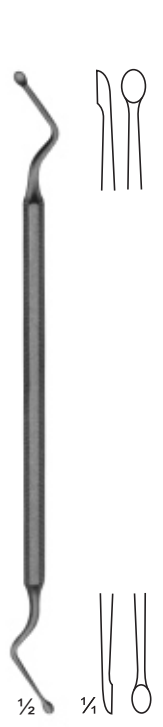

06-8181
HEMINGWAY
170 mm

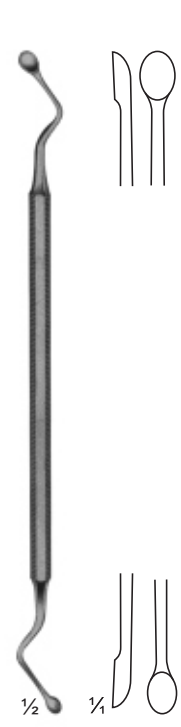

06-8182
HEMINGWAY
175 mm

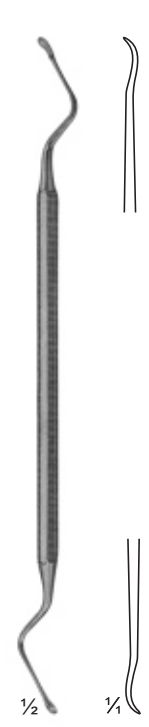

06-8183
LUCAS
180 mm

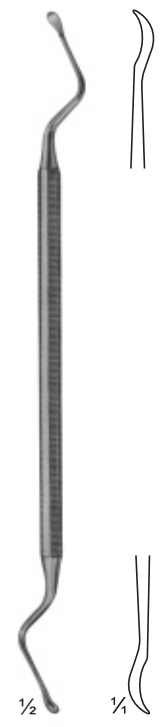

06-8184
LUCAS
185 mm



06-8185 - 06-8187
KERPEL
145 mm



06-8186 - 06-8188
KERPEL
145 mm

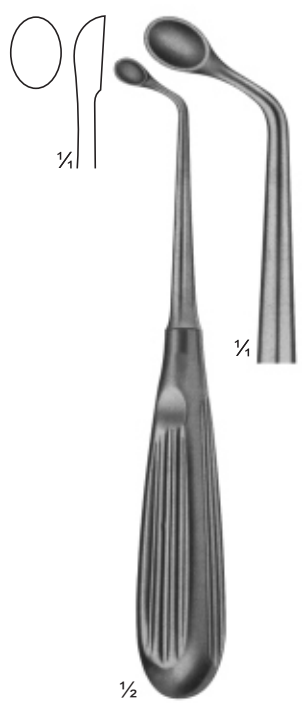

06-8189
UFFENORDE
170 mm



06-8190
UFFENORDE
170 mm

Bone Curettes

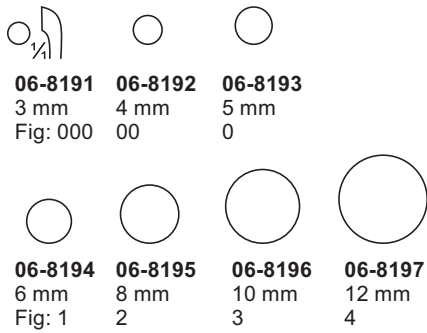

½

06-8191 - 06-8197
BRUNS
165 mm

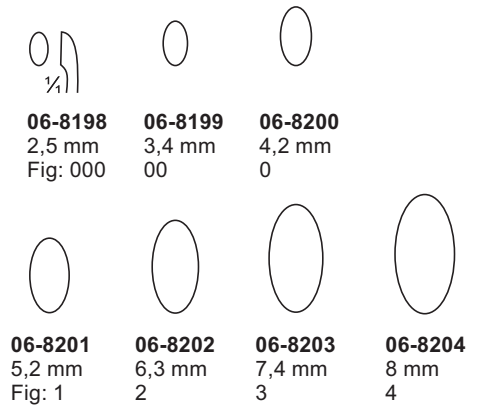

½

06-8198 - 06-8204
SCHEDE
170 mm

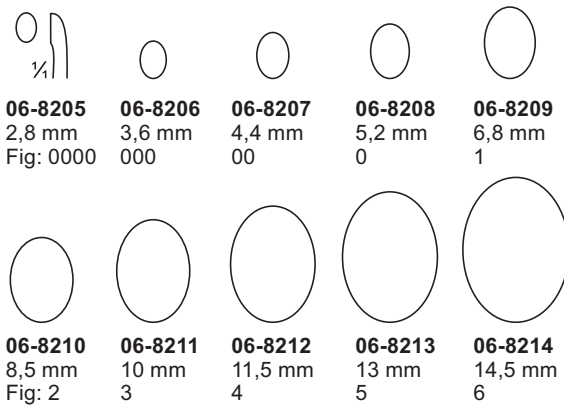

½

06-8205 - 06-8214
VOLKMANN
170 mm

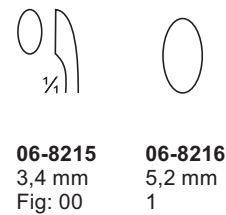

½

06-8215 - 06-8216
WILLIGER
170 mm

Bone Curettes



0
06-8217
1,8 mm

0
06-8218
2,0 mm

0
06-8219
2,4 mm

0
06-8220
2,6 mm

1/4
06-8221
2,8 mm

06-8217 - 06-8221
LEMPERT
215 mm



0
06-8222
4,4 mm
Fig: 00

0
06-8223
5,2 mm
Fig: 0

1/4
06-8224
6,8 mm
Fig: 1

06-8222 - 06-8224
HALLE
215 mm



0
06-8225
2,8 mm
Fig: 0000

0
06-8226
3,6 mm
Fig: 000

0
06-8227
4,4 mm
Fig: 00

1/4
06-8228
5,2 mm
Fig: 0

06-8225 - 06-8228
DAUBENSPECK
200 mm



0
06-8229
3,6 mm
Fig: 000

0
06-8230
4,4 mm
Fig: 00

0
06-8231
5,2 mm
Fig: 0

1/4
06-8232
6,8 mm
Fig: 1

06-8229 - 06-8232
250 mm



0
06-8233
3,6 mm
Fig: 000

0
06-8234
4,4 mm
Fig: 00

0
06-8235
5,2 mm
Fig: 0

1/4
06-8236
6,8 mm
Fig: 1

06-8233 - 06-8236
250 mm



0
06-8237
3 mm

0
06-8238
4 mm

1/4
06-8239
5 mm

06-8237 - 06-8239
BUSHE 250 mm

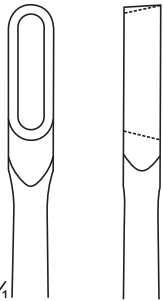

Bone Currettes

6 mm





1/2

06-8240
TESSIER
220 mm

06-8241
3,6 mm
Fig: 000



06-8242
4,4 mm
Fig: 00





1/4

06-8243
5,2 mm
Fig: 0

06-8241 - 06-8243
SIMON
235 mm

1/2

06-8244
6,8 mm
Fig: 1



06-8245
8,5 mm
Fig: 2

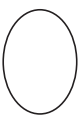

06-8246
10 mm
Fig: 3



06-8247
11,5 mm
Fig: 4

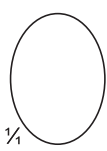

1/4

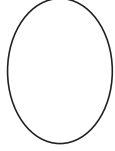

06-8248
13 mm
Fig: 5



06-8249
14,5 mm
Fig: 6

06-8244 - 06-8249
SIMON
240 mm

1/2

06-8250
3,6 mm
Fig: 000



06-8251
4,4 mm
Fig: 00



1/4

06-8252
5,2 mm
Fig: 0

06-8250 - 06-8252
CASPAR
220 mm

1/2

06-8253
3,6 mm
Fig: 000



06-8254
4,4 mm
Fig: 00





1/4

06-8255
5,2 mm
Fig: 0

06-8253 - 06-8255
CASPAR
220 mm

1/2

06-8256
4 mm



06-8257
5 mm



1/4

06-8258
6 mm

06-8256 - 06-8258
CASPAR
toothed
220 mm

1/2

Bone Curettes With Hartpress Handle



can be sterilized in a steam sterilizer upto 3 bar over pressure (143°C).

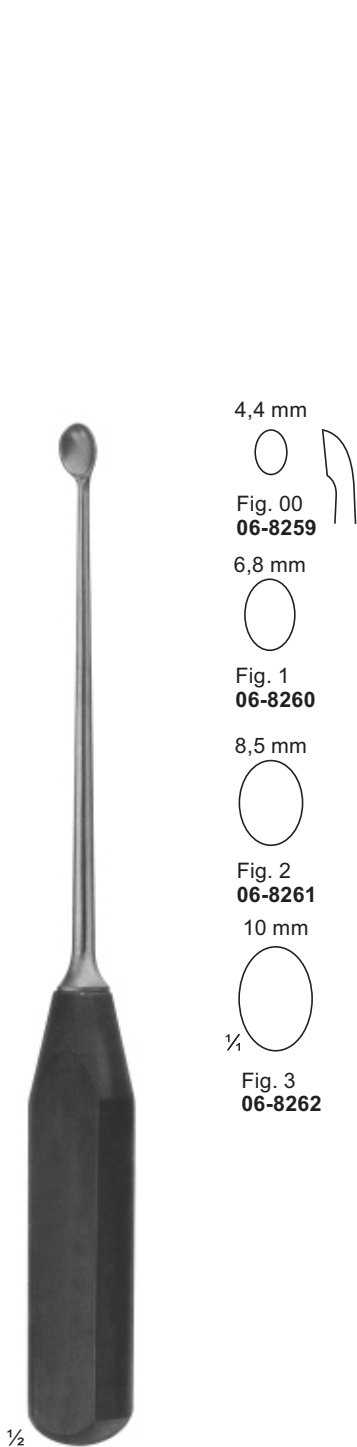

06-8259 - 06-8262
270 mm

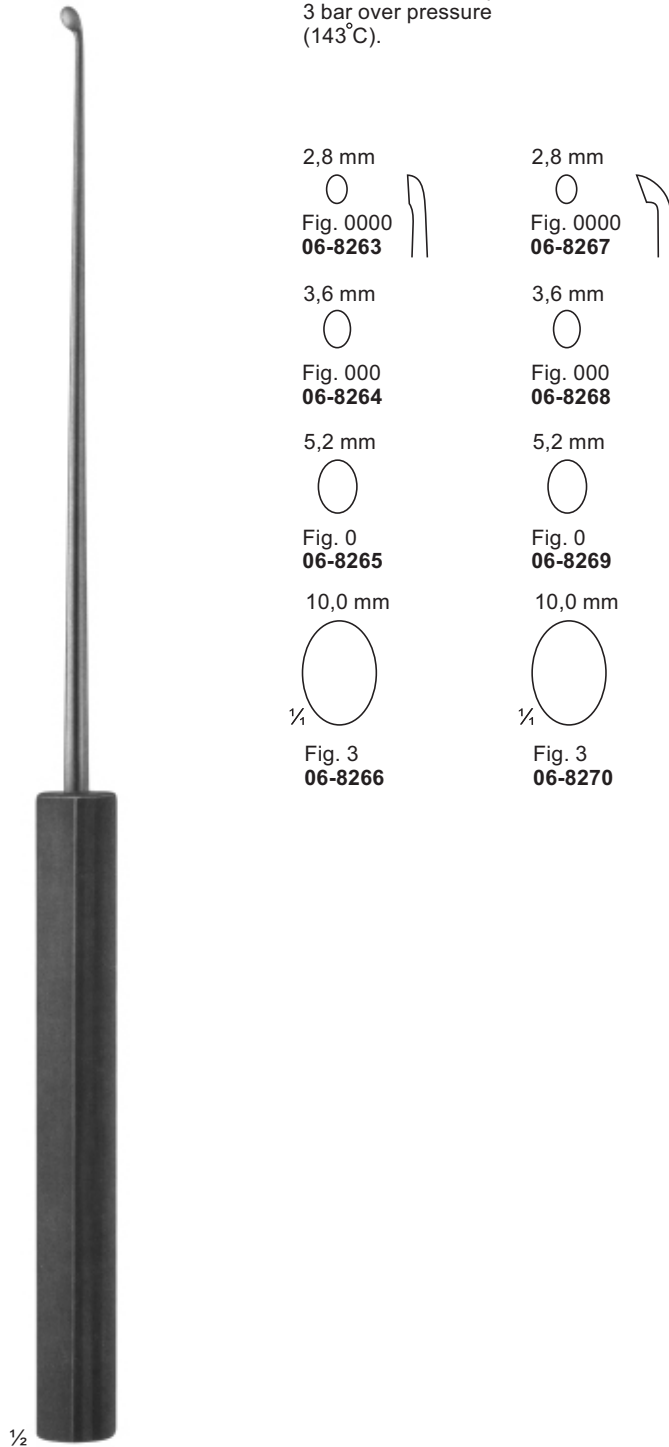

06-8263 - 06-8270
SYPERT
380 mm

Mallets Weight Refer To The Heads Of The Mallets



∅20 mm

½

06-8271
MEAD
185 g
with interchangeable
plastic disks
190 mm
06-8272
pair of spare disks



∅25 mm

½

06-8273
140 g
with interchangeable
plastic disks
185 mm
06-8274
pair of spare disks



∅30 mm

½

06-8275
COTTLE
240 g
1 Side flat
1 Side convex
185 mm



∅22 mm

½

06-8276
165 g
lead filled head
190 mm



06-8277
HAJEK
140 g
220 mm



06-8278
215 g
with interchangeable
plastic disks
245 mm
06-8279
pair of spare disks

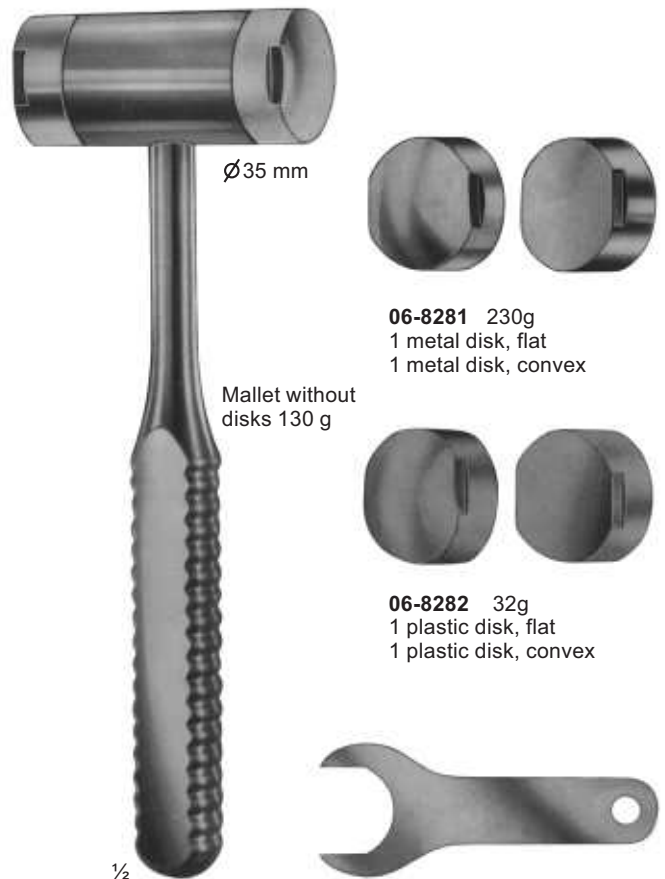

06-8280 - 06-8283
WAGNER
complete with:
1 pair of metal disks (**06-8281**) and
1 pair of plastic disks (**06-8282**) and
1 wrench (**06-8283**)
235 mm

06-8281 230g
1 metal disk, flat
1 metal disk, convex

Mallet without
disks 130 g

06-8282 32g
1 plastic disk, flat
1 plastic disk, convex

06-8283
Wrench

Mallets Weight Refer To The Heads Of Th Mallets



06-8284 300g
BERGMANN
245 mm



06-8285 300g
BERGMANN
235 mm



06-8286 550g
OMBREDANNE
240 mm

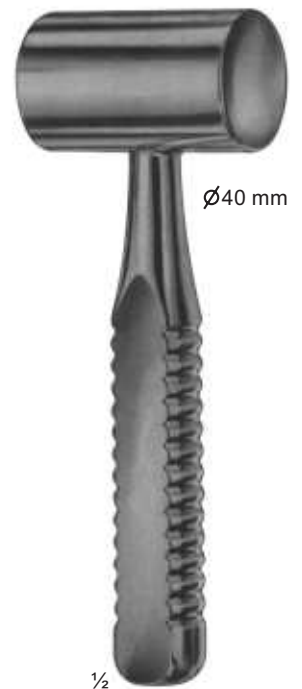

06-8287
HEATH
copper filled head
700 g
185 mm

Tampers - Osteotomes, Chisels and Gouge

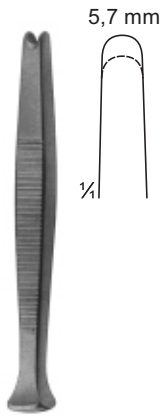

06-8288
HAASE
100 mm



06-8289 - 06-8290
PASSOW
120 mm



06-8291 - 06-8293
CASPAR
200 mm



06-8294 - 06-8296
200 mm

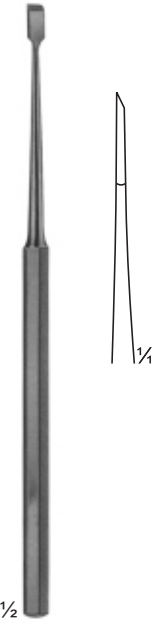

06-8297 4mm
FREER
Chisel
160 mm

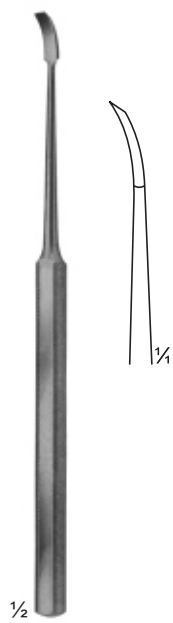

06-8298 4mm
FREER
Chisel, curved
160 mm

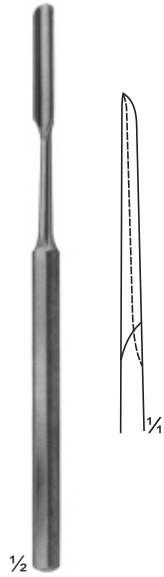

06-8299 6mm
FREER
Gouge
150 mm

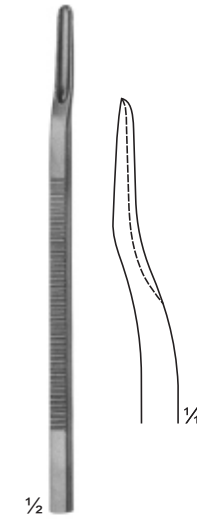

06-8300 3.4mm
Scaphoid gouge,
downwards curved
135 mm

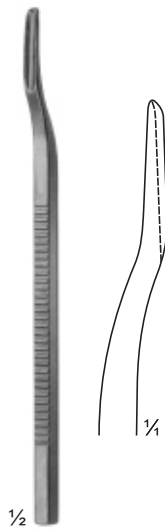

06-8301 3.4mm
Scaphoid gouge,
upwards curved
135 mm

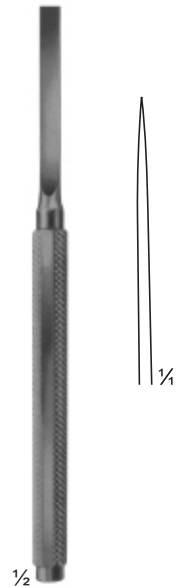

06-8302 - 06-8304
MANNERFELT modif
Osteotomes
06-8302 4 mm
06-8303 6 mm
06-8304 8 mm
155 mm

Osteotomes Chisels and Gouges

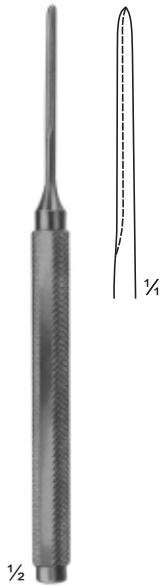

06-8305 3mm
MANNERFELT modif.
Gouge
155 mm

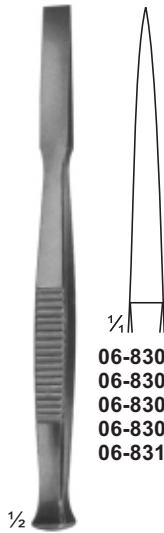

06-8306 - 06-8310
Osteotomes
140 mm

- 06-8306** 4 mm
- 06-8307** 6 mm
- 06-8308** 8 mm
- 06-8309** 10 mm
- 06-8310** 12 mm

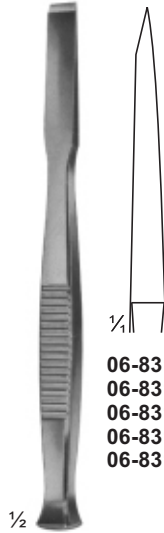

06-8311 - 06-8315
Chisels
140 mm

- 06-8311** 4 mm
- 06-8312** 6 mm
- 06-8313** 8 mm
- 06-8314** 10 mm
- 06-8315** 12 mm

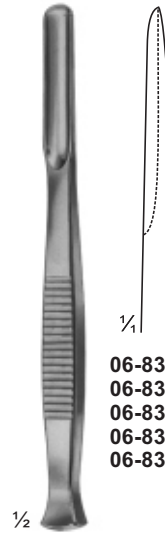

06-8316 - 06-8320
Gouges
140 mm

- 06-8316** 4 mm
- 06-8317** 6 mm
- 06-8318** 8 mm
- 06-8319** 10 mm
- 06-8320** 12 mm

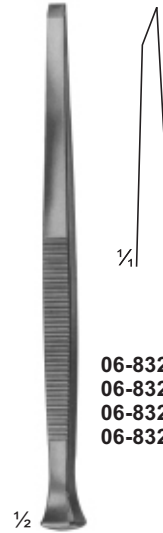

PARTSCH
06-8321 - 06-8324
Chisels
140 mm

- 06-8321** 3 mm
- 06-8322** 4 mm
- 06-8323** 5 mm
- 06-8324** 6 mm

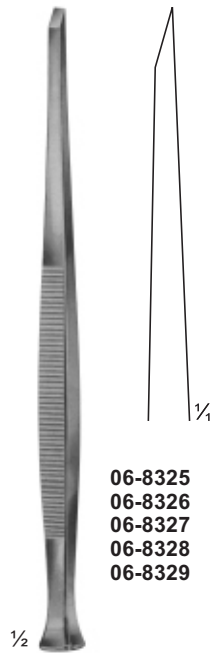

PARTSCH
06-8325 - 06-8329
Chisels
170 mm

- 06-8325** 3 mm
- 06-8326** 4 mm
- 06-8327** 5 mm
- 06-8328** 6 mm
- 06-8329** 7 mm

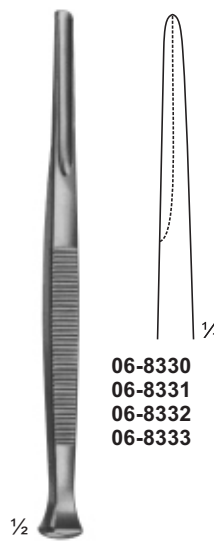

PARTSCH
06-8330 - 06-8333
Gouges
140 mm

- 06-8330** 3 mm
- 06-8331** 4 mm
- 06-8332** 5 mm
- 06-8333** 6 mm

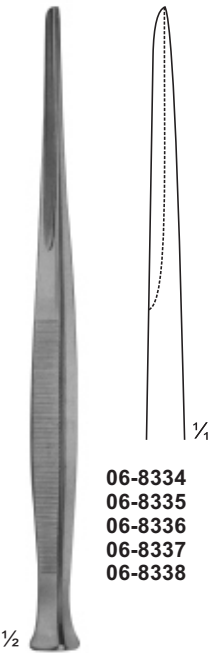

PARTSCH
06-8334 - 06-8338
Gouges
170 mm

- 06-8334** 3 mm
- 06-8335** 4 mm
- 06-8336** 5 mm
- 06-8337** 6 mm
- 06-8338** 7 mm

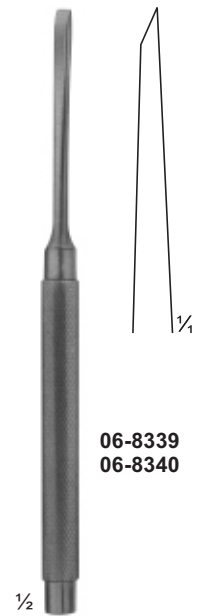

LUCAS
06-8339 - 06-8340
Chisels
160 mm

- 06-8339** 4 mm
- 06-8340** 6 mm

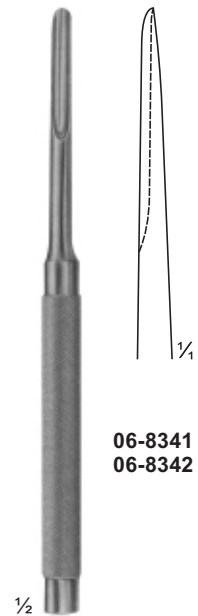

LUCAS
06-8341 - 06-8342
Gouges
160 mm

- 06-8341** 3 mm
- 06-8342** 5 mm

Osteotomes Chisels and Gouges

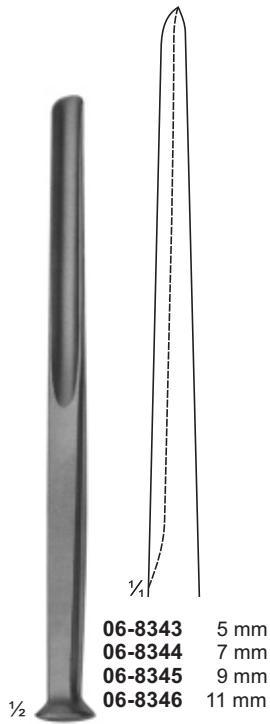

- 06-8343 5 mm
- 06-8344 7 mm
- 06-8345 9 mm
- 06-8346 11 mm

ALEXANDER
06-8343 - 06-8346
Gouges
170 mm

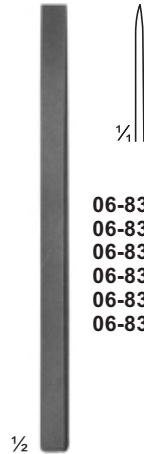

- 06-8347 4 mm
- 06-8348 6 mm
- 06-8349 8 mm
- 06-8350 10 mm
- 06-8351 12 mm
- 06-8352 15 mm

LAMBOTTE
06-8347 - 06-8352
Osteotomes
125 mm

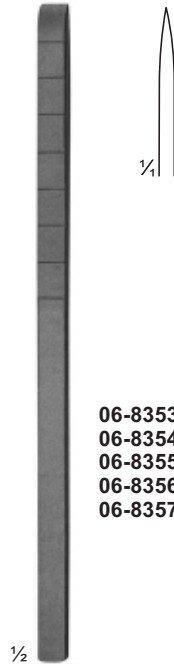

- 06-8353 4 mm
- 06-8354 6 mm
- 06-8355 8 mm
- 06-8356 10 mm
- 06-8357 12 mm

COTTLE
06-8353 - 06-8357
Osteotomes with depth
markings
180 mm

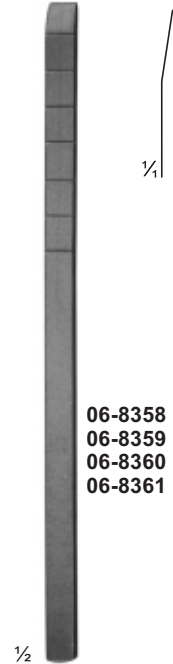

- 06-8358 4 mm
- 06-8359 7 mm
- 06-8360 9 mm
- 06-8361 12 mm

COTTLE
06-8358 - 06-8361
Chisel-Osteotomes
with depth markings
180 mm

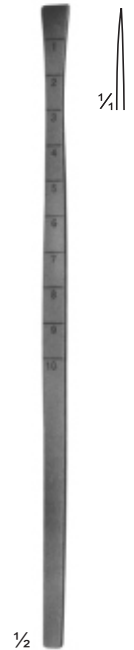

COTTLE
06-8362 8mm
Fish-tail Chisel,
with protected ends
180 mm

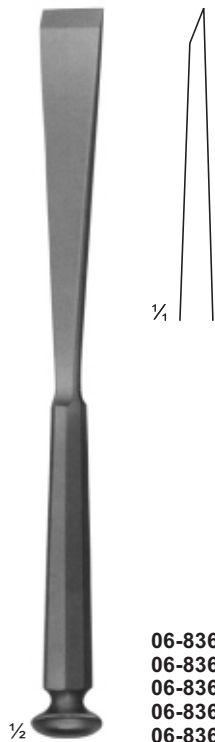

- 06-8363 10 mm
- 06-8364 12 mm
- 06-8365 15 mm
- 06-8366 20 mm
- 06-8367 25 mm

STILLE
06-8363 - 06-8367
Chisels
205 mm

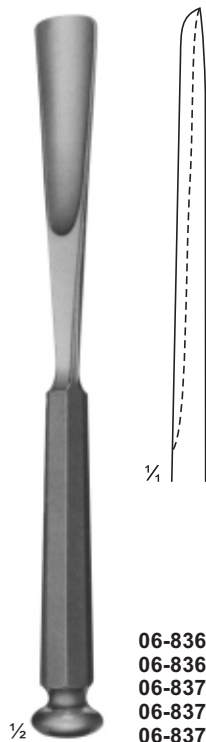

- 06-8368 10 mm
- 06-8369 12 mm
- 06-8370 15 mm
- 06-8371 20 mm
- 06-8372 25 mm

STILLE
06-8368 - 06-8372
Gouges
205 mm

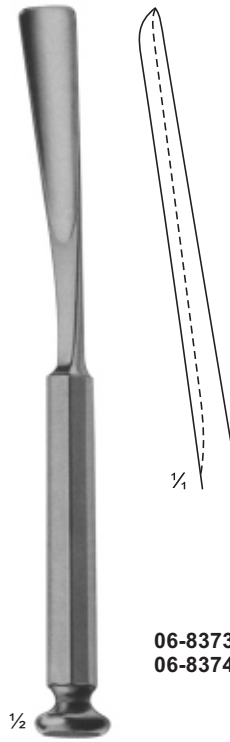

- 06-8373 10 mm
- 06-8374 15 mm

WALTER
06-8373 - 06-8374
gouges for taking
grafts from the ribs
205 mm



- 06-8375 8mm
- 06-8376 10 mm
- 06-8377 12 mm
- 06-8378 15 mm
- 06-8379 20 mm
- 06-8380 25 mm

STILLE
06-8375 - 06-8380
Osteotomes
205 mm

Osteotomes

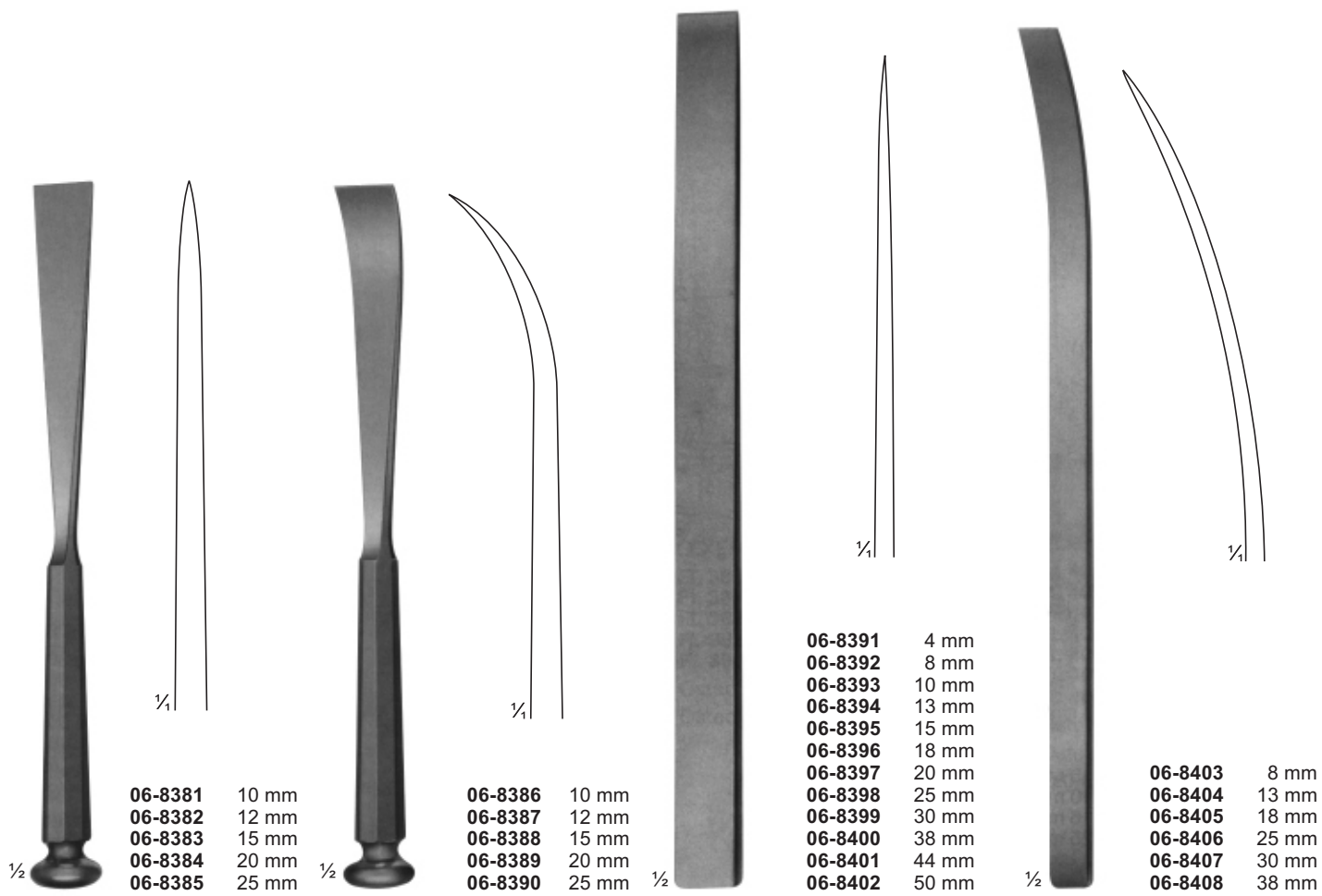

STILLE
06-8381 - 06-8385
 Osteotomes
 205 mm

STILLE
06-8386 - 06-8390
 Osteotomes, curved
 205 mm

LAMBOTTE
06-8391 - 06-8402
 Osteotomes
 245 mm

LAMBOTTE
06-8403 - 06-8408
 Osteotomes, curved
 245 mm

Osteotomes, Chisels and Gouges with HARTPRESS -handle

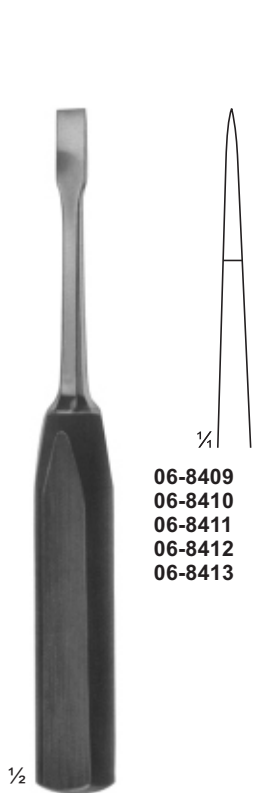

- 06-8409** 4 mm
- 06-8410** 6 mm
- 06-8411** 8 mm
- 06-8412** 10 mm
- 06-8413** 12 mm

LEXER-MINI
06-8409 - 06-8413
Osteotomes
180 mm



- 06-8414** 4 mm
- 06-8415** 6 mm
- 06-8416** 8 mm
- 06-8417** 10 mm
- 06-8418** 12 mm

LEXER-MINI
06-8414 - 06-8418
Gouges
180 mm

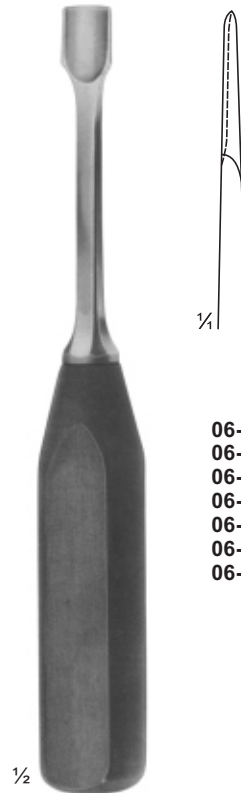

- 06-8419** 5 mm
- 06-8420** 7 mm
- 06-8421** 10 mm
- 06-8422** 15 mm
- 06-8423** 20 mm
- 06-8424** 25 mm
- 06-8425** 30 mm

LEXER
06-8419 - 06-8425
Gouges
220 mm



- 06-8426** 5 mm
- 06-8427** 7 mm
- 06-8428** 10 mm
- 06-8429** 15 mm
- 06-8430** 20 mm
- 06-8431** 25 mm
- 06-8432** 30 mm

LEXER
06-8426 - 06-8432
Osteotomes
220 mm



06-8433 9mm
Gouge for
removing broken
screws
220 mm



- 06-8434** 5,5 mm
- 06-8435** 9,0 mm

ZIELKE
06-8434 - 06-8435
Gouges for
scoliosis-operations
230 mm

Osteotomes ,Chisels and Gouges with HARTPRESS -handle



06-8436 10 mm
06-8437 15 mm

06-8438 10 mm
06-8439 15 mm

06-8440 20mm
 Chisel
 245 mm

06-8441 16mm
 Chisel, curved
 265 mm

LEXER
06-8436 - 06-8437
 Osteotomes,
 angled
 275 mm

LEXER
06-8438 - 06-8439
 Gouges,
 angled
 275 mm

Reposition Forceps



06-8442
 Reposition forceps,
 for small fragments
 135 mm

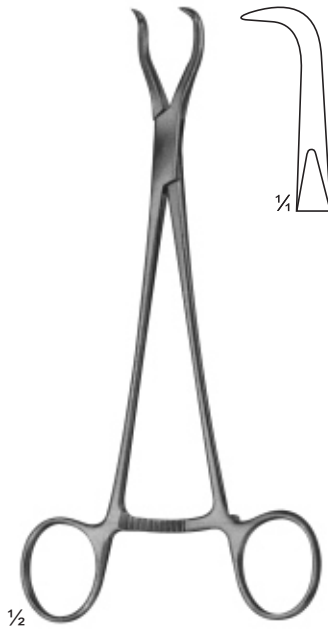

06-8443
 HAASE
 Reposition forceps,
 for mandibular
 fractures
 165 mm

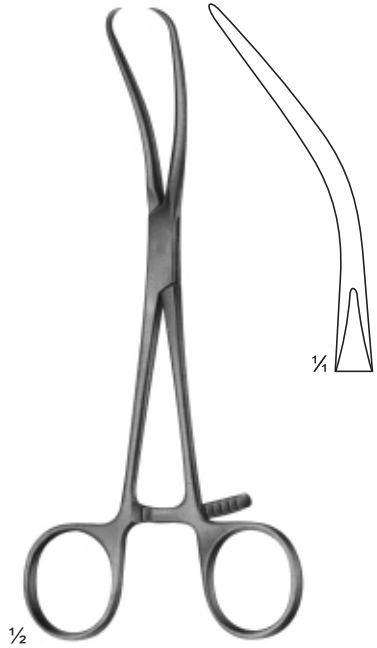

06-8444
 REILL
 Reposition forceps,
 170 mm



06-8445
 Reposition forceps
 205 mm

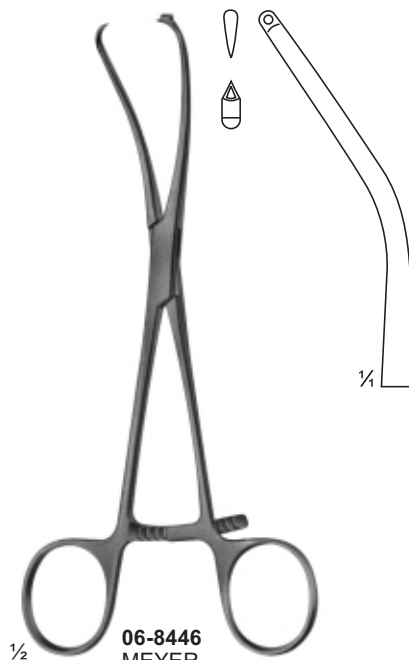
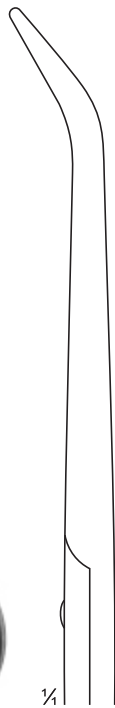

06-8446
 MEYER
 Reposition forceps
 for fingers, with drill
 guide for KIRSCHNER
 wires up to daim.1.0 mm
 170 mm



06-8447
Patella forceps
185 mm



06-8448
Forceps with
ratchet fixation
140 mm



06-8449
Forceps with
thread fixation
170 mm



06-8450
Forceps with
thread fixation
235 mm

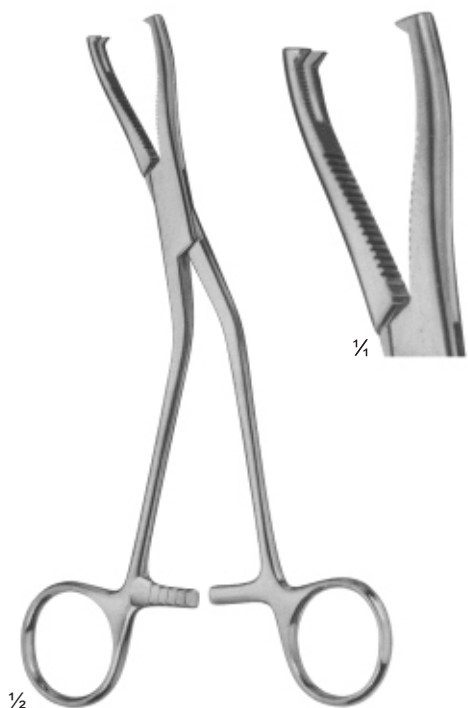

06-8451
DINGMANN modif
185 mm

Bone Holding Forceps



06-8452
Sequestrum
forceps
200 mm



06-8453
VAN BUREN
Sequestrum
forceps
225 mm



06-8454
LANGENBECK
205 mm



06-8455
FERGUSON
205 mm

Bone Holding Forceps

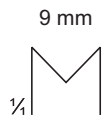
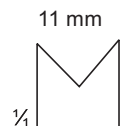
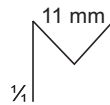
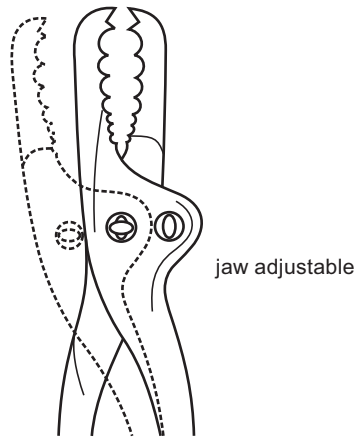

06-8456
SEMB
190 mm



06-8457
FARABEU
230 mm



06-8458
FARABEU
255 mm



06-8459
FARABEU-LAMBOTTE
255 mm

Bone Holding Forceps

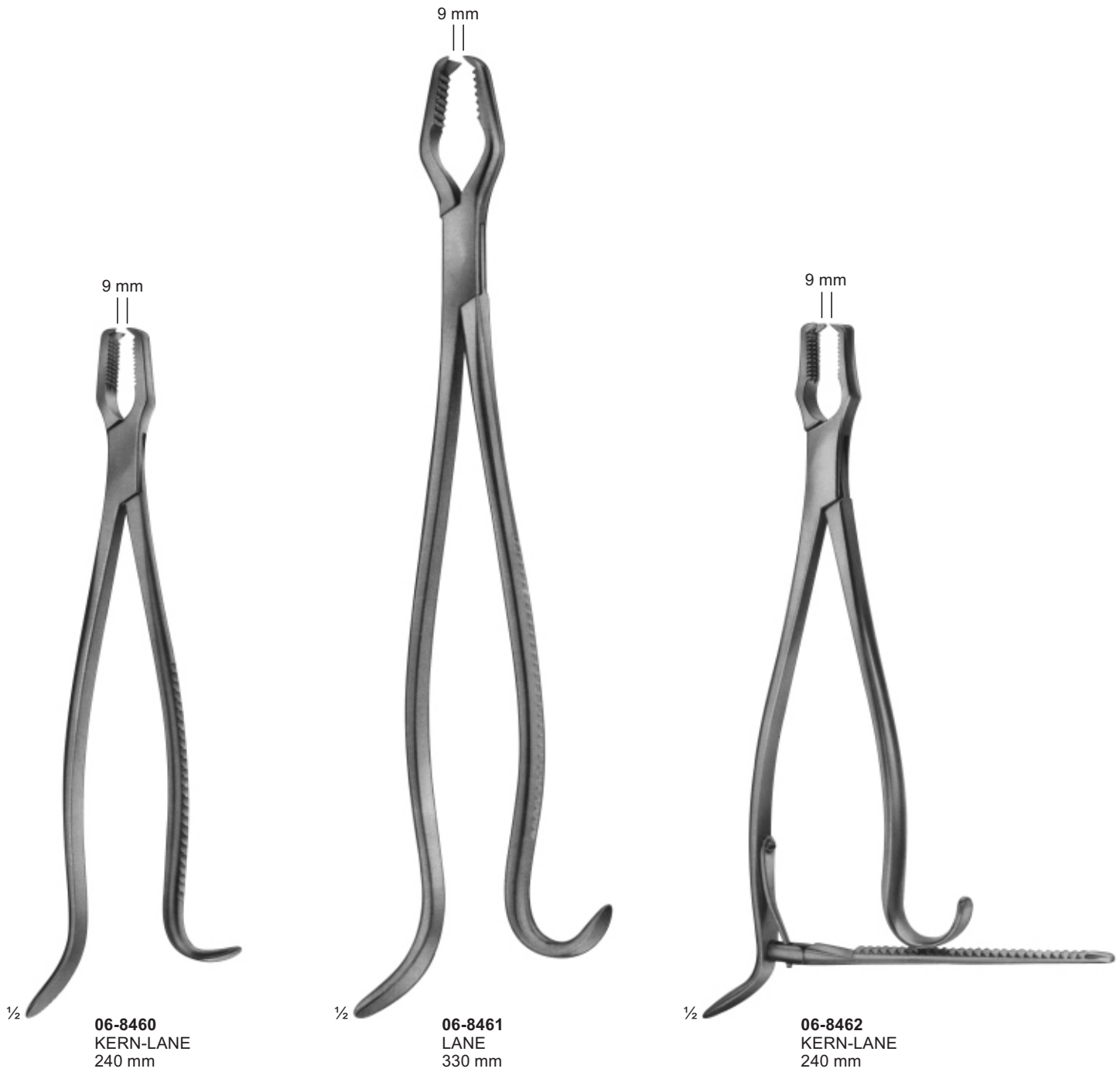

Bone Holding Forceps



06-8463
LANE
320 mm



06-8464
HEY GROVES
305 mm

Bone Holding Forceps



06-8465 - 06-8469

- 06-8465** 145 mm
- 06-8466** 190 mm
- 06-8467** 240 mm
- 06-8468** 260 mm
- 06-8469** 280 mm

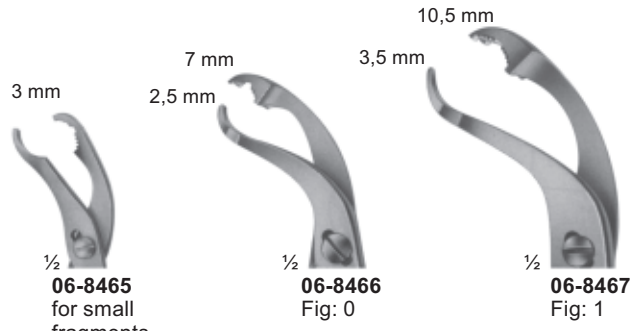

06-8465
for small
fragments
11 mm

06-8466
Fig: 0

06-8467
Fig: 1

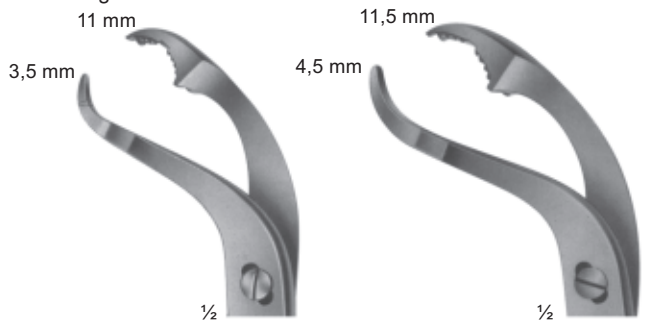

06-8468
Fig: 2

06-8469
Fig: 3

Self-centering forceps
with thread fixation

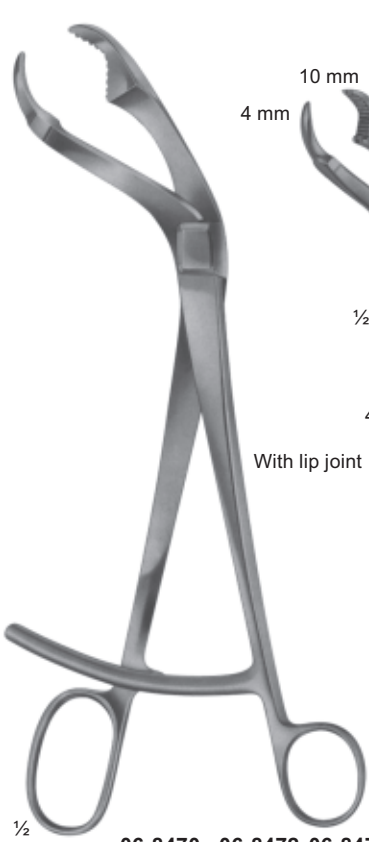

06-8470 - 06-8472 **06-8470** 255 mm
VERBRUGGE **06-8471** 265 mm
06-8472 270 mm

With lip joint

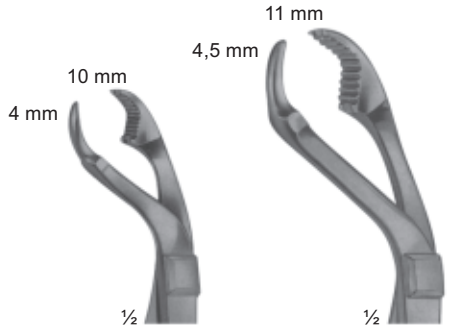

06-8470
Fig: 1

06-8471
Fig: 2



06-8472
Fig: 3



06-8473
LAMBOTTE
265 mm

Movable jaw

movable jaw

Bone Clamps



06-8474 - 06-8475
LOWMAN
06-8474 170 mm
06-8475 205 mm



06-8476
LOWMAN-GERSTER
 210 mm

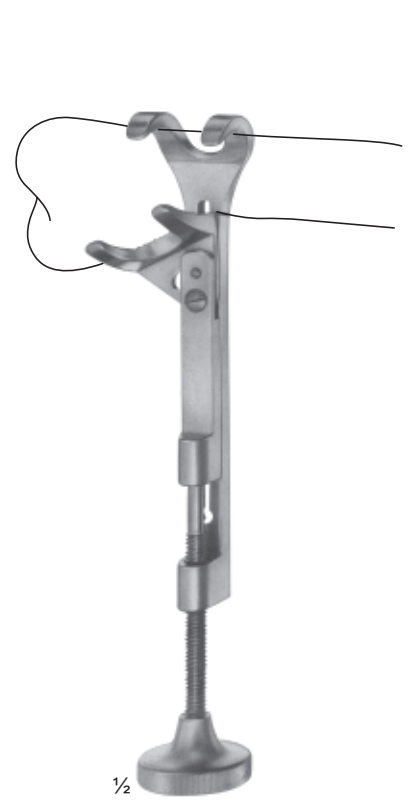

06-8477
LOWMAN-HOGLUND
 175 mm

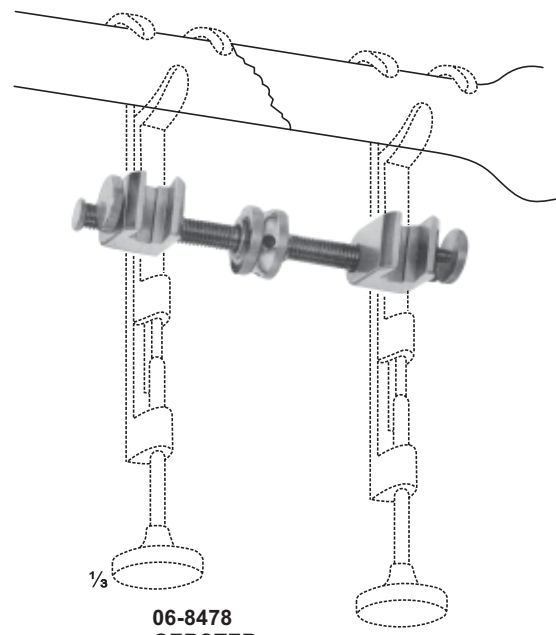

06-8478
GERSTER
 Traction bar for **06-8474 - 06-8477**

Synovectomy-Rongeurs, Bone Rongeurs



06-8479 - 06-8480
Synovectomy rongeur
width of jaws 1.2 mm
130 mm



06-8481 - 06-8482
Synovectomy rongeur
width of jaws 2.0 mm
130 mm

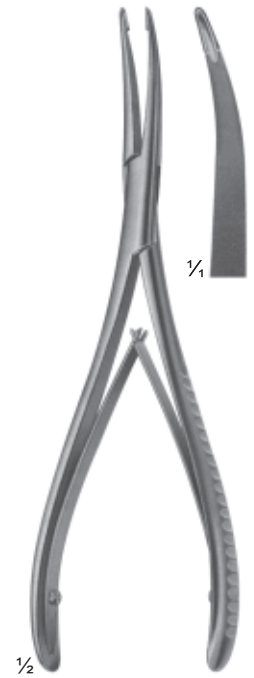

06-8483
STELLBRINK
Synovectomy rongeur
175 mm

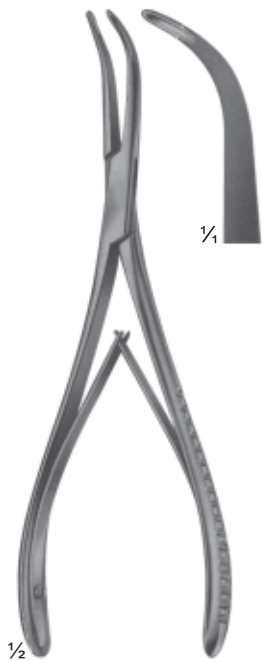

06-8484
STELLBRINK
Synovectomy rongeur
170 mm

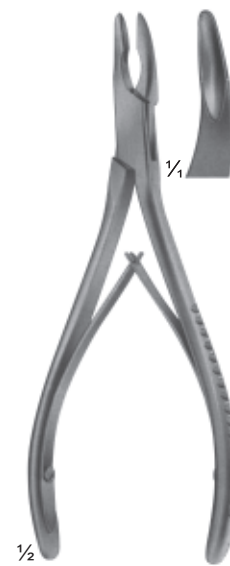

06-8485
LUER-FRIEDMANN
145 mm

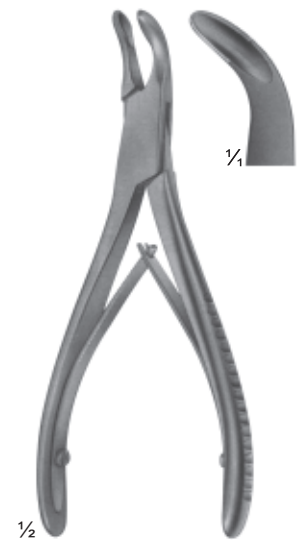

06-8486
140 mm

Bone Rongeurs



06-8487
LUER
150 mm

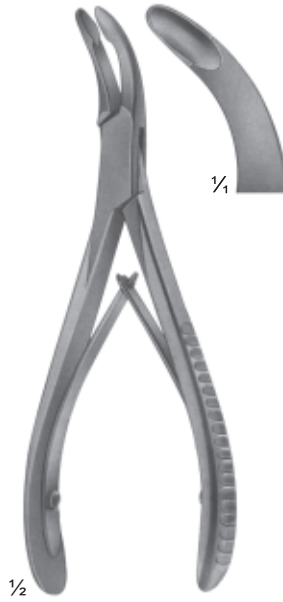

06-8488
LUER
155 mm

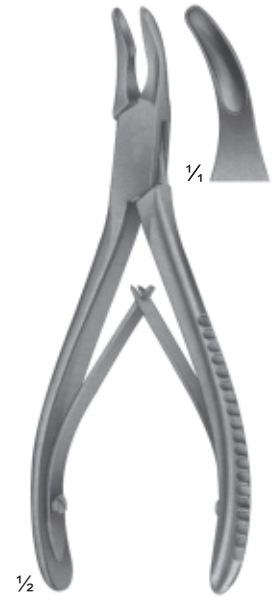

06-8489
BLUMENTHAL
155 mm

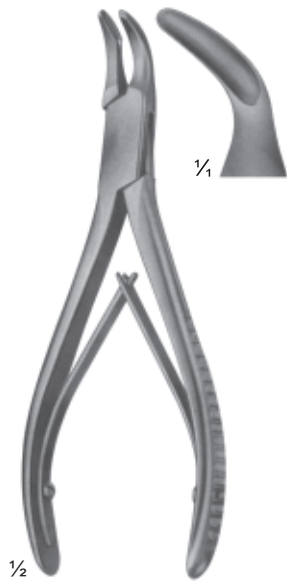

06-8490
BLUMENTHAL
150 mm



06-8491 - 06-8492
JANSEN
175 mm

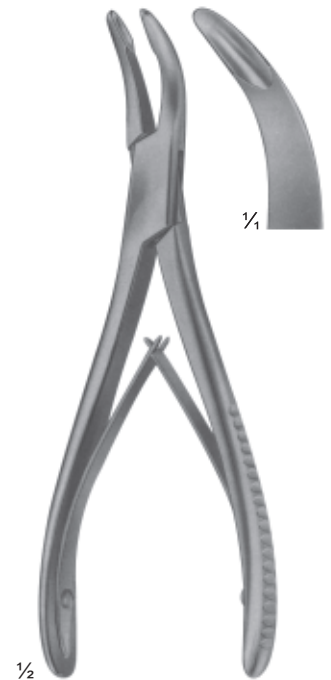

06-8493
BANE-HARTMANN
175 mm

Bone Rongeurs



06-8494
ALEXANDER
140 mm

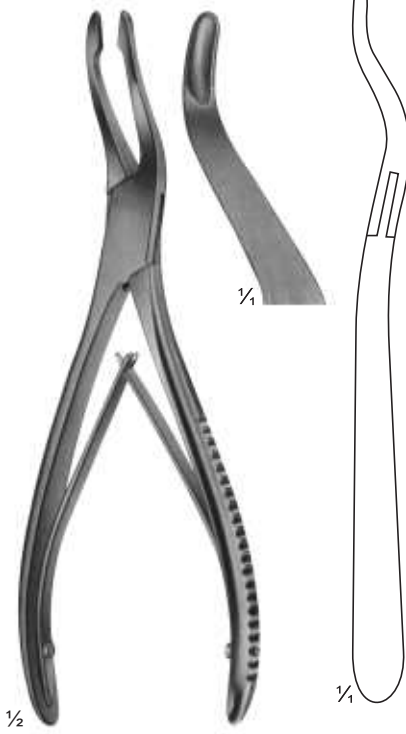

06-8495
JANSEN
190 mm

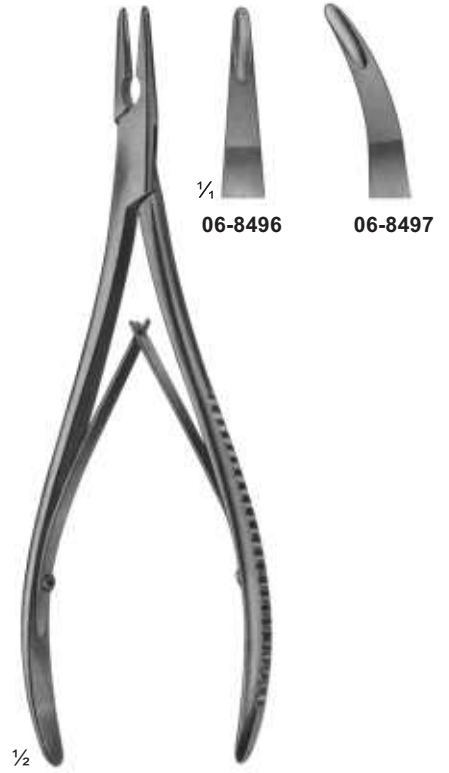

06-8496 - 06-8497
LEMPERT
200 mm

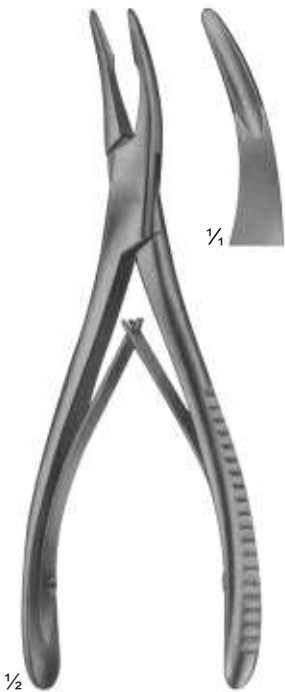

06-8498
BEYER
180 mm



06-8499
MEAD
165 mm

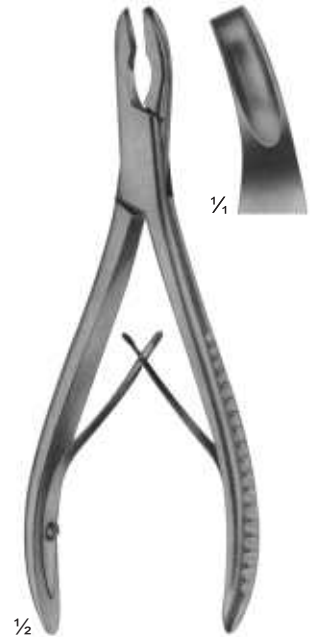

06-8500
MEAD
165 mm

Bone Rongeurs

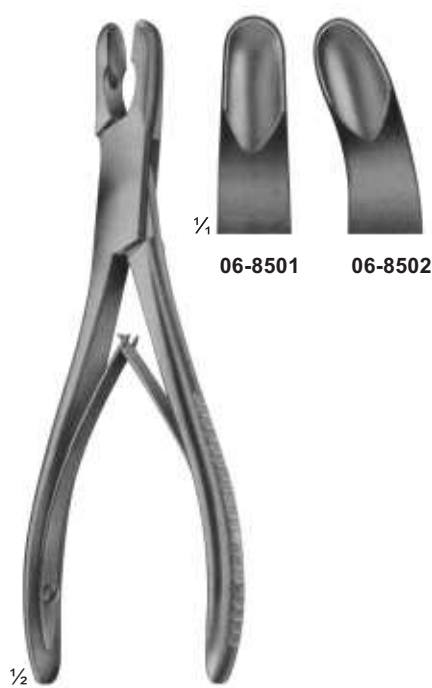

06-8501 06-8502

06-8501 - 06-8502
LUER
175 mm



06-8503
LUER
180 mm

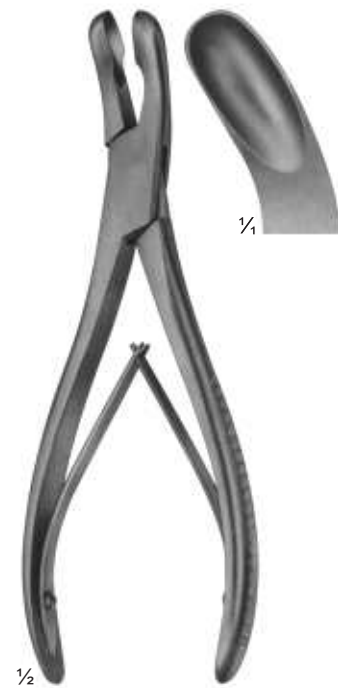

06-8504
LUER
180 mm



06-8505
OLIVECRONA
205 mm



06-8506 - 06-8507
BOHLER
155 mm



06-8508
MARQUARDT
200 mm



06-8509
RUSKIN
190 mm



06-8510
ROETTGEN-RUSKIN
240 mm



06-8511 - 06-8512
ECHLIN
230 mm



06-8513
STILLE
235 mm



06-8514
LEKSELL-STILLE
240mm



06-8515
STILLE-RUSKIN
240mm



06-8516
LUER-STILLE
225 mm



06-8517
LUER-STILLE
225 mm



06-8518
LUER-STILLE
270 mm

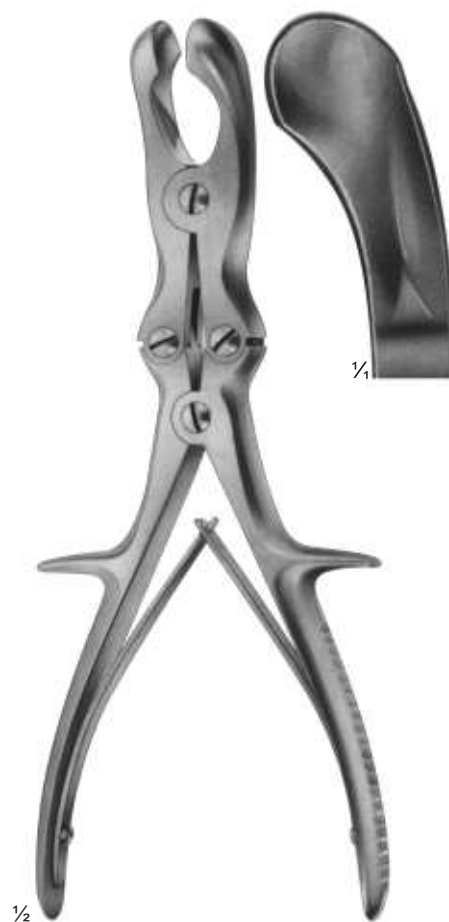

06-8519
SEMB
240 mm

Bone Cutting Forceps

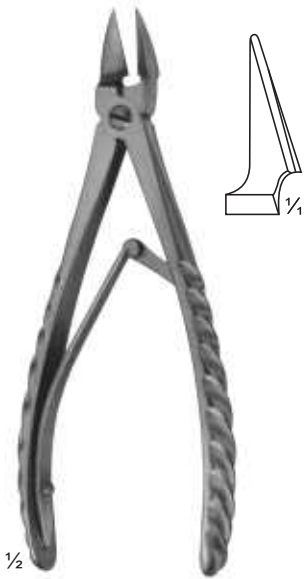

06-8520
STAMM
150 mm



06-8521
KAZANJIAN
185 mm

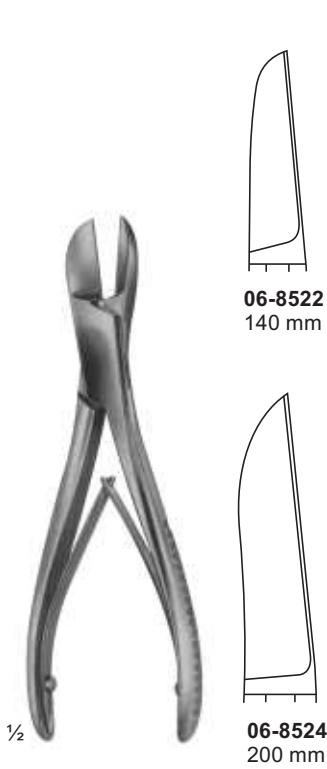

06-8522 - 06-8525
LISTON

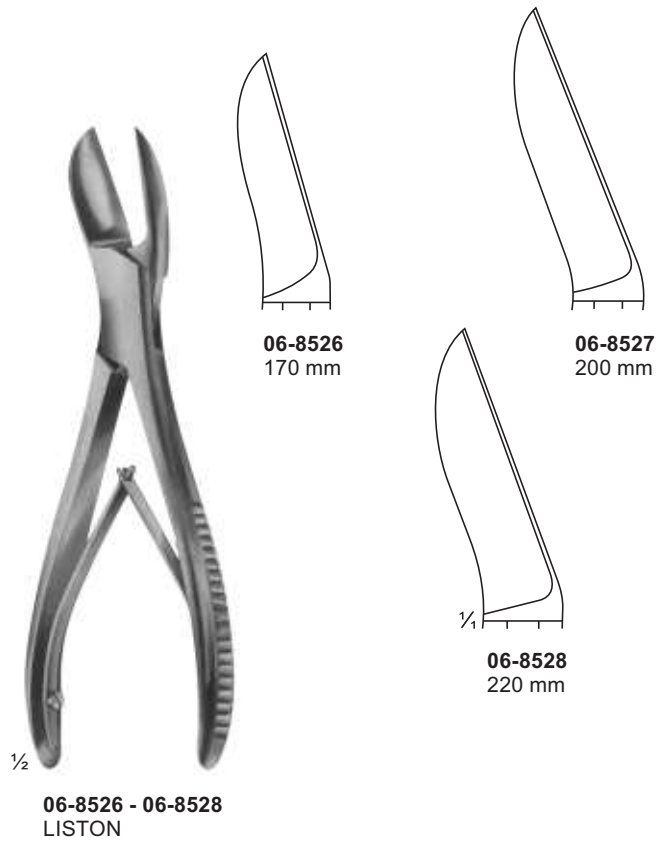
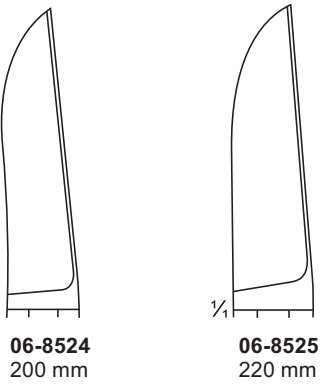
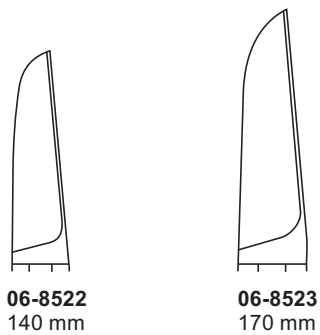

06-8526 - 06-8528
LISTON

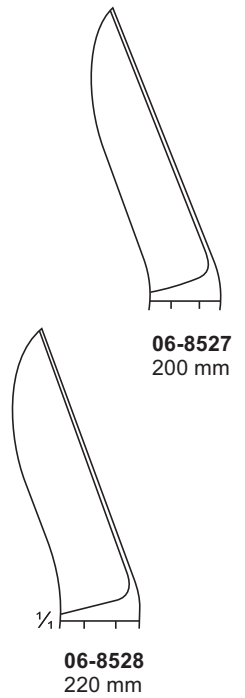

Bone Cutting Forceps



06-8529
BOEHLER
145 mm



06-8530
RUSKIN-LISTON
190 mm



06-8531
RUSKIN-LISTON
190 mm

Bone Cutting Forceps

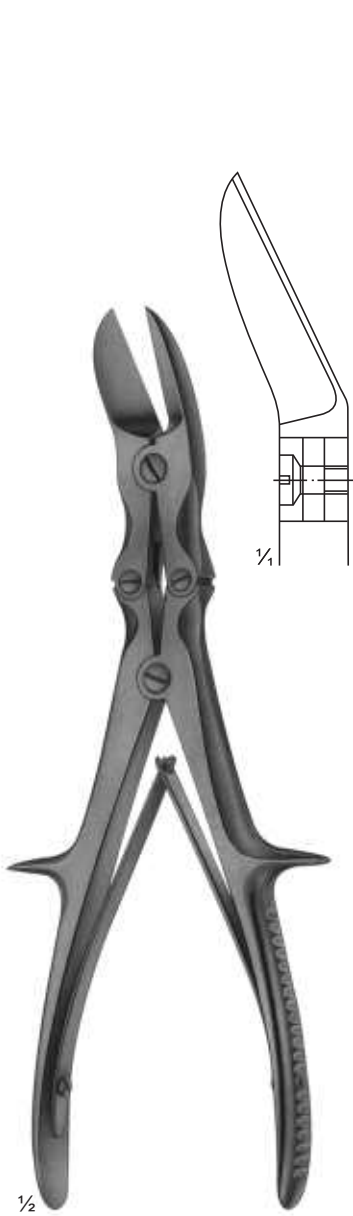

06-8532
LISTON
curved on flat
240 mm

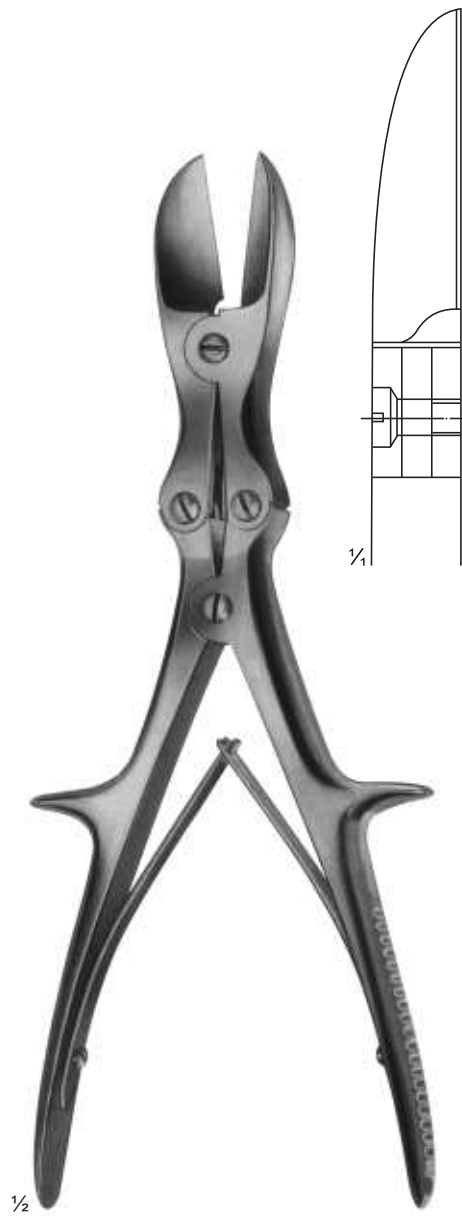

06-8533
LISTON
straight
280 mm

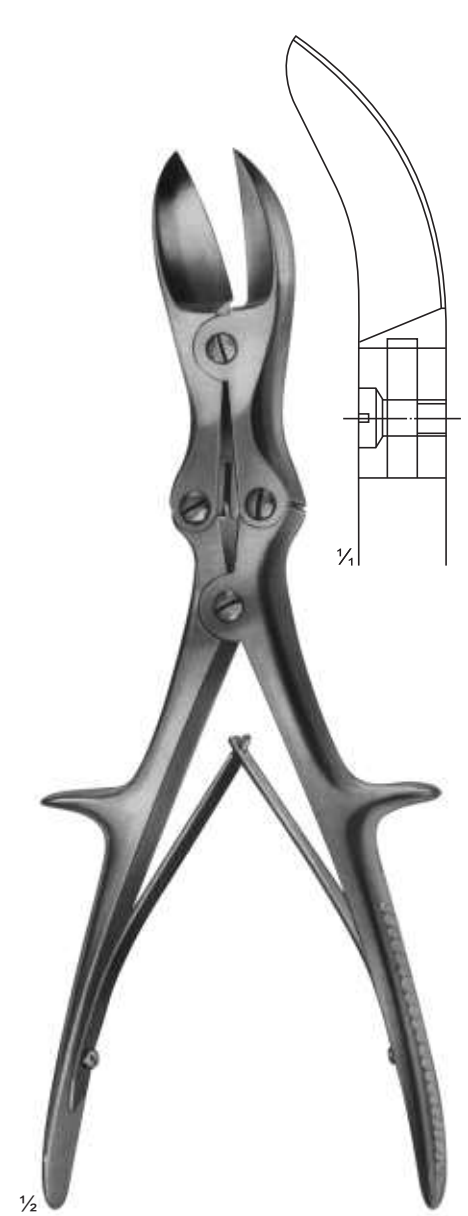

06-8534
LISTON
curved on flat
280 mm

Bone Cutting Forceps

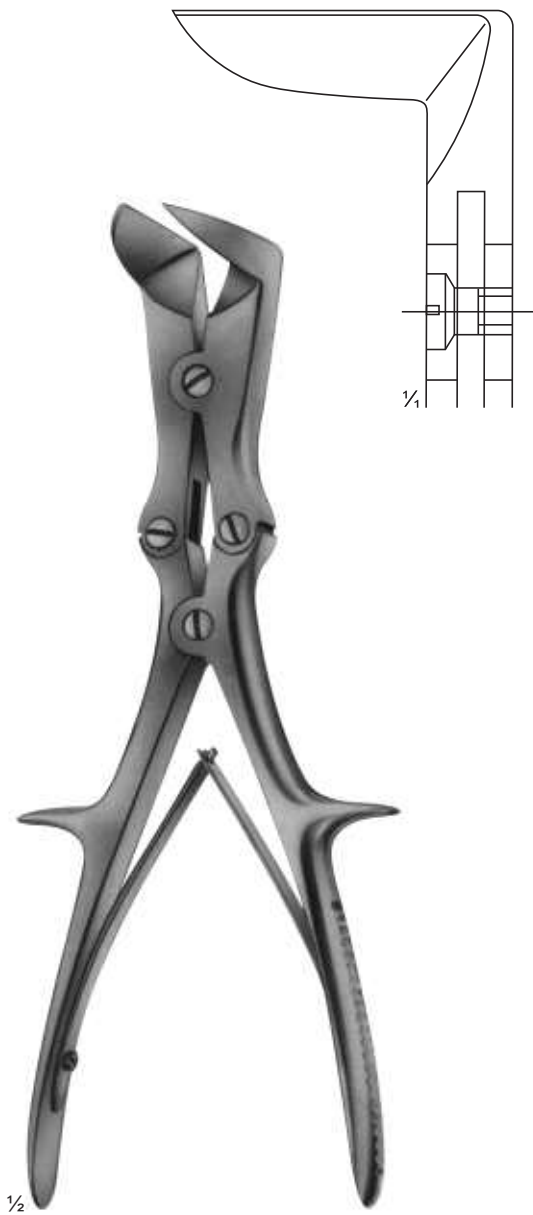

06-8535
LISTON-STILLE
265 mm

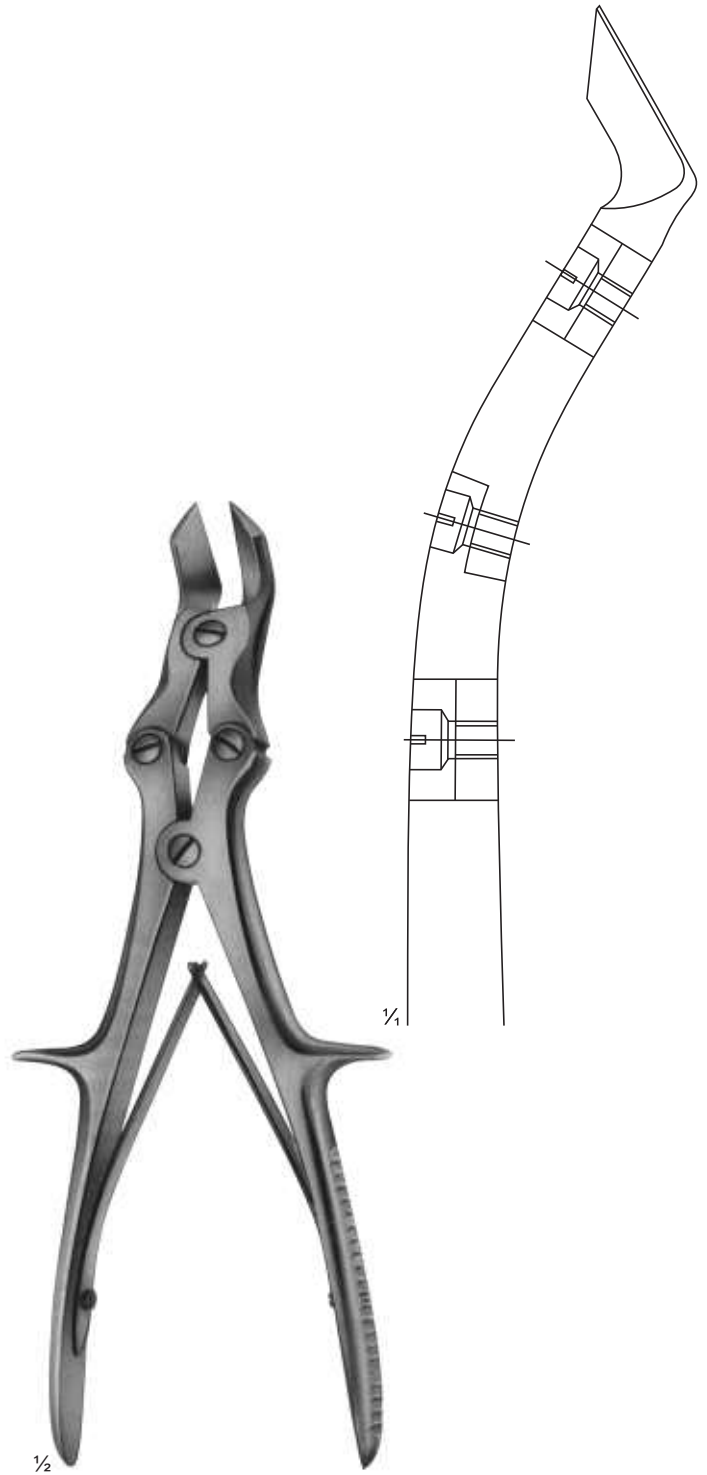

06-8536
LISTON-KEY-HORSLEY
(TUDOR EDWARDS)
255 mm

Meniscus-and Cartilage Forceps

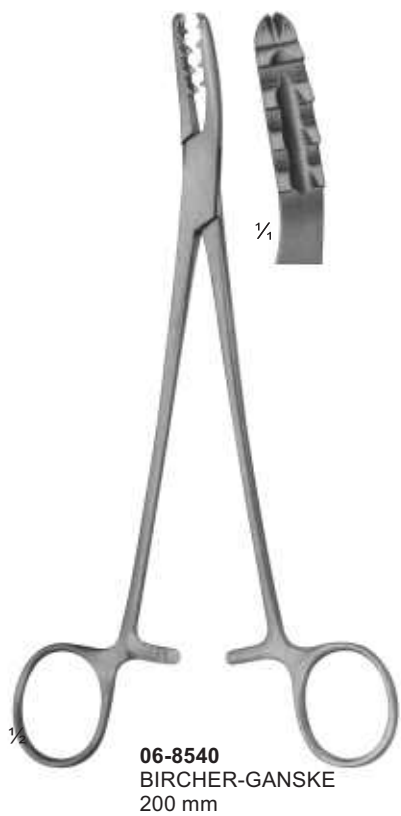
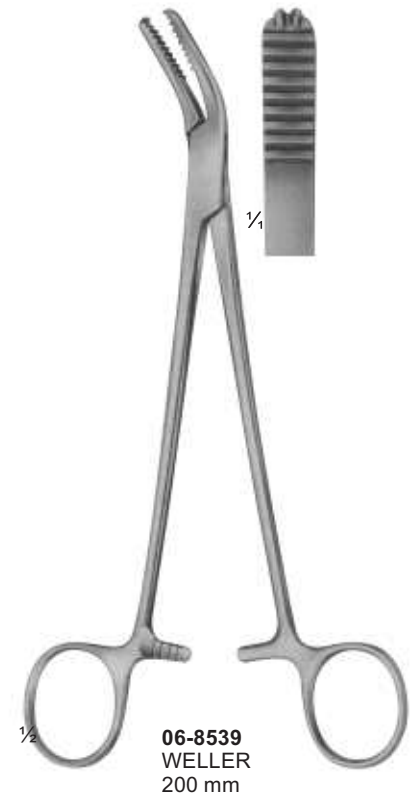

Meniscus Knives

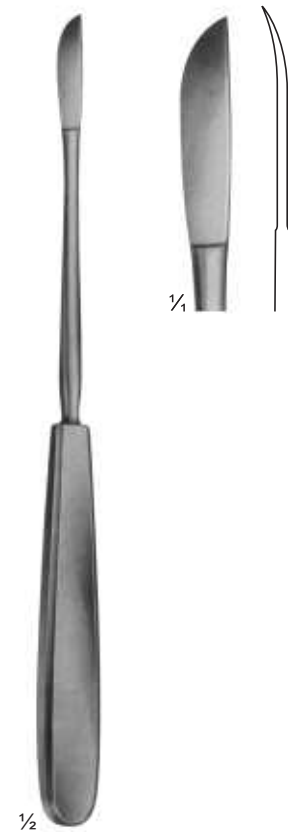
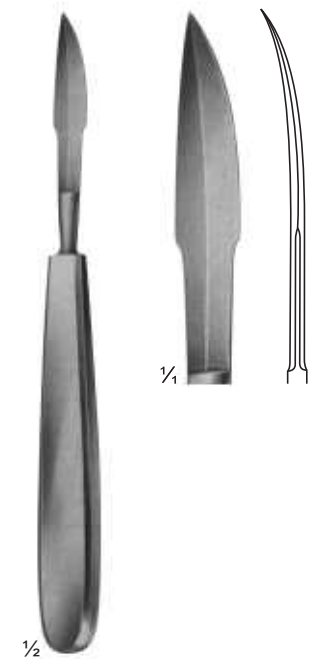

Meniscus Knives

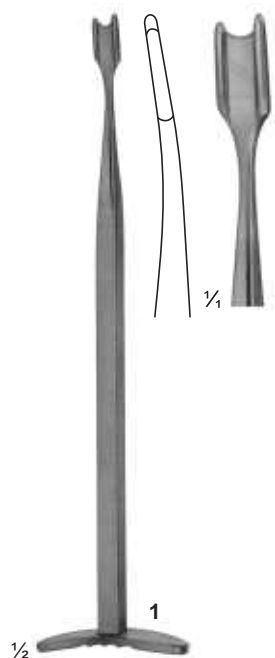

06-8547
SMILLIE
170 mm

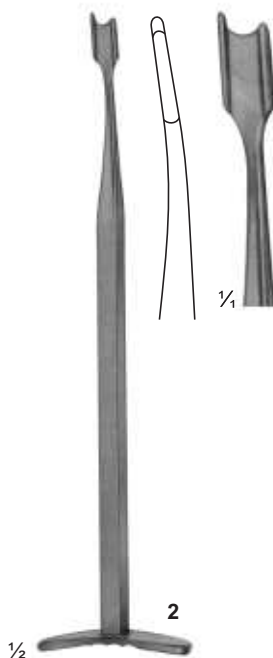

06-8548
SMILLIE
170 mm

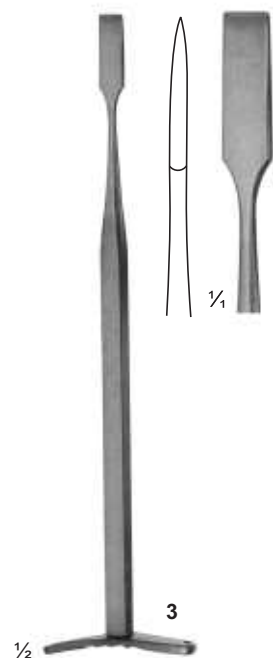

06-8549
SMILLIE
170 mm

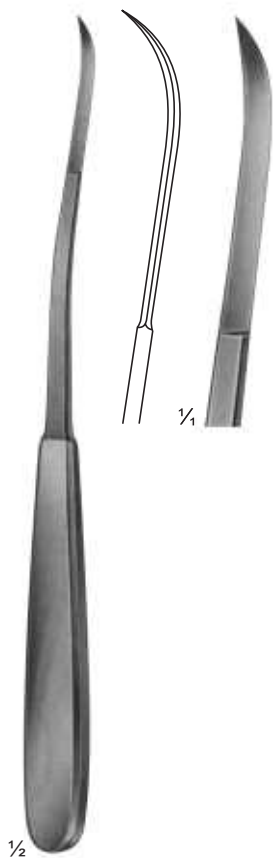

06-8550
SALENIUS
220 mm

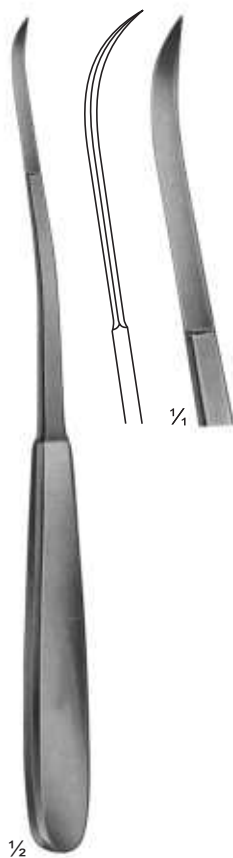

06-8551
SALENIUS
220 mm

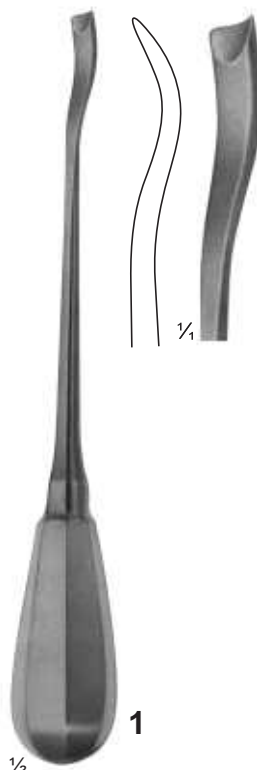

06-8552
CANAD. MODELL
200 mm

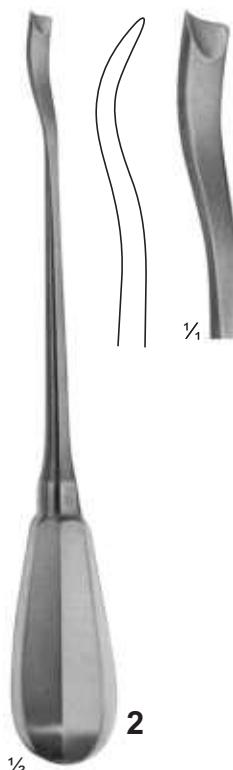

06-8553
CANAD. MODELL
200 mm

Wire Extension

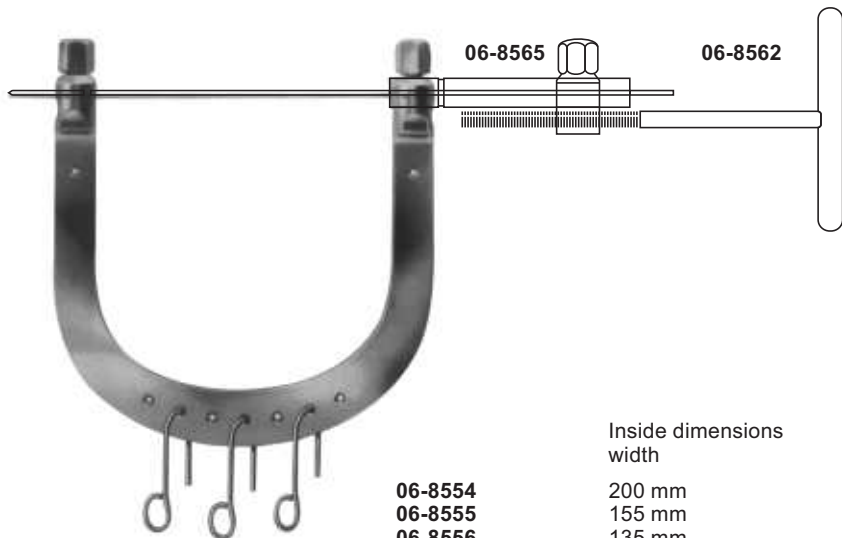

06-8554 - 06-8560
KIRSCHNER
 Wire traction bows,
 to be used with
 KIRSCHNER-wires
 up to 2.5 mm diam.,
 With 3 hooks,
 stainless steel

	Inside dimensions width	depth	
06-8554	200 mm	155 mm	for the hip
06-8555	155 mm	155 mm	for the femur
06-8556	135 mm	130 mm	for the knee
06-8557	120 mm	120 mm	for the knee
06-8558	105 mm	100 mm	for the knee
06-8559	95 mm	110 mm	for the calcaneus
06-8560	95 mm	70 mm	for the arm and elbow



06-8561
 Wrench, double - ended,
 for wire traction bows



06-8562
 Wire tightener, with
 clamping jaws



1/3

06-8563
 Traction hook only,
 large size



1/3

06-8564
 Traction hook only,
 small size



1/3

06-8565
 Fixation clamp, to secure clamping
 jaws of **06-8562** stainless steel

Wire Extension

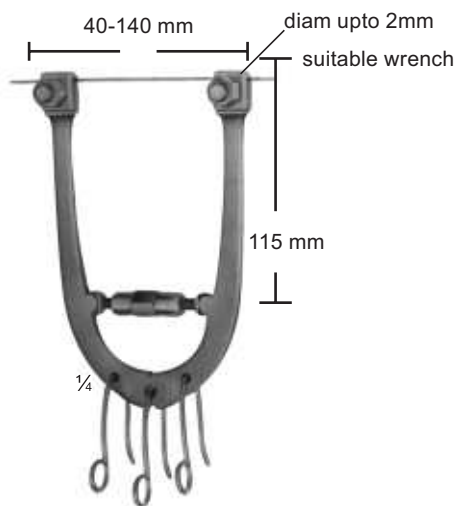

06-8566
Wire traction bow, adjustable, with 3 hooks, small size

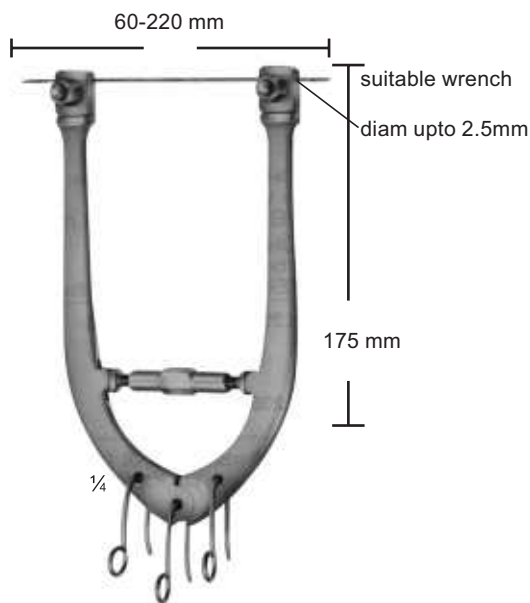

06-8567
Wire traction bow, adjustable, with 3 hooks, large size

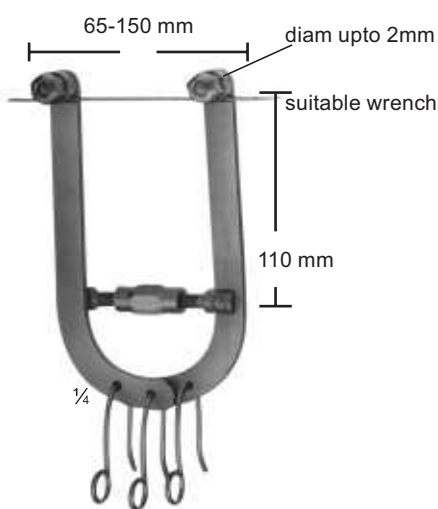

06-8568
Wire traction bow, adjustable, with 3 hooks, small size for elbow and calcaneus, for adolescents

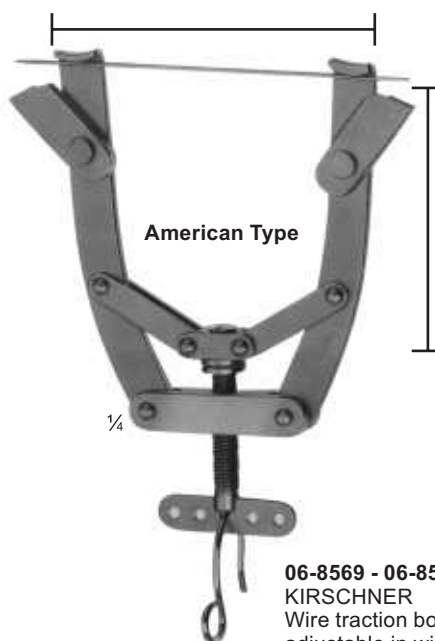

06-8569 max. 105 mm
06-8570 max. 160 mm
06-8571 max. 200 mm

06-8569 80-95 mm
06-8570 90-120 mm
06-8571 140-170 mm

diam upto
06-8569 1,6 mm
06-8570 2,0 mm
06-8571 2,5 mm

06-8569 - 06-8571
KIRSCHNER
Wire traction bows, modified, adjustable in width, holds wire securely, with 1 hook



06-8572
Fixation disc, slotted



06-8573
idem, aluminum, transparent to X-rays



06-8574
Fixation disc, slotted



06-8575
Screw driver, for above fixations discs

Traction Bows, Distractor



Boehler traction bows, to be used with STEINMANN pins, 4mm diam	Boehler traction bows, to be used with STEINMANN pins, 5mm diam	Inside width	For
06-8576 with pin (09-8588)		16x9cm	Arm
06-8577 without pin	06-8582 without pin		
06-8578 with pin (09-8590)		21x11cm	Femur and knee
06-8579 without pin	06-8583 without pin		
06-8580 with pin (09-8592) 06-8581 without pin		21x15cm	Femur and knee



06-8584 - 06-8598
STEINMANN
triangular shaft ended and trocar point

diam Ø	4,0 mm	5,0 mm
Length		
80 mm	06-8584	
100 mm	06-8585	
120 mm	06-8586	
140 mm	06-8587	
150 mm	06-8588	06-8594
160 mm	06-8589	
180 mm	06-8590	06-8595
200 mm	06-8591	06-8596
210 mm	06-8592	
250 mm	06-8593	06-8597
300 mm		06-8598



06-8599
SCHWARZ
Traction bow for fingers,
to be used with KIRSCHNER-
wire up to 1.6 mm diam.



06-8600
Small distractor
as a repositioning device for
distraction and compression of small bones,
for wires with 3.0 mm diam.



06-8601
Protection cap
for 4,0 mm STEINMANN Pins



06-8602
Protection cap
for 5,0 mm STEINMANN Pins



1/2

06-8603
REILL
Drilling chuck,
cannulated,
for shanks from
2.0 - 2.5 mm diam
115 mm



1/2

06-8604
Drilling chuck,
cannulated,
for shanks from
0.8 - 2.0 mm diam
150 mm



1/2

06-8605
Drilling chuck,
cannulated,
for shanks up to
4.5 mm diam
with key
140 mm

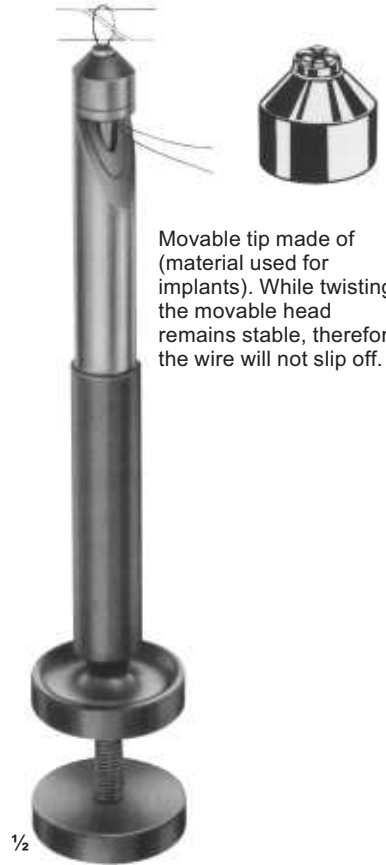

1/2

06-8606
LOUTE
Wire tightener, improved pattern,
with movable tip,
for wires up to 1.0 mm diam.
220 mm

Movable tip made of (material used for implants). While twisting the movable head remains stable, therefore the wire will not slip off.

Chuck jaws made of material used for implants



1/2

06-8607
Drilling chuck, cannulated,
for shanks up to 6.35 mm diam.,
To be tightened by hand
100 mm



1/2

06-8608
Drilling chuck, cannulated,
for shanks up to 4.5 mm diam.,
And for triangular shaft width
across flats 4.7 mm (schanz screws,
steinmann pins). with key **06-8609**

06-8609



1/2

06-8610
Drilling chuck, cannulated,
for shanks up to 6.35 mm diam.,
With key **(06-8611)**
160 mm

06-8611

Cerclage Instruments

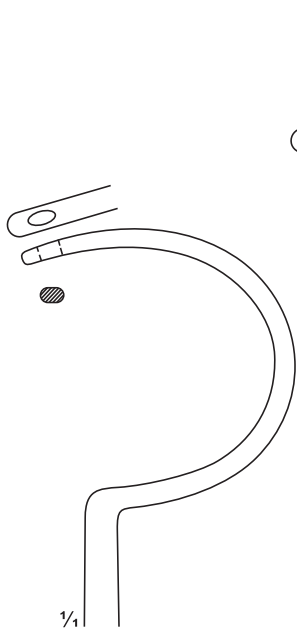

06-8612
275 mm

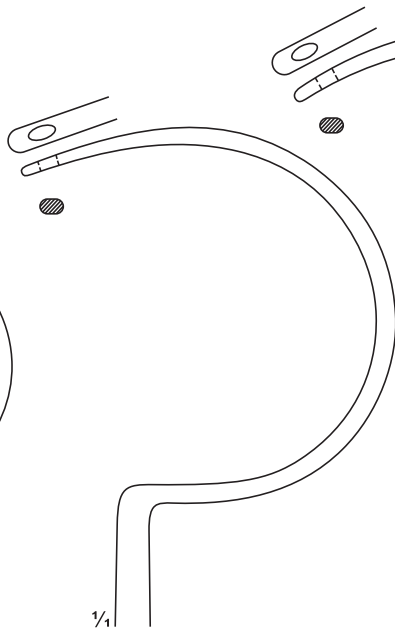

06-8613
285 mm

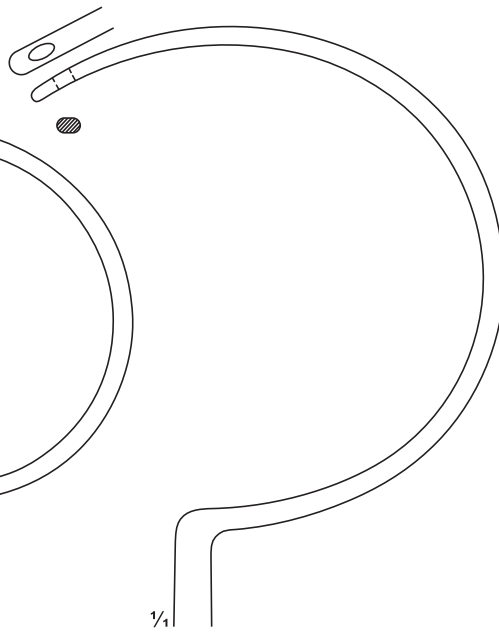

06-8614
305 mm



06-8612 - 06-8614
DEMEL
Wire guides

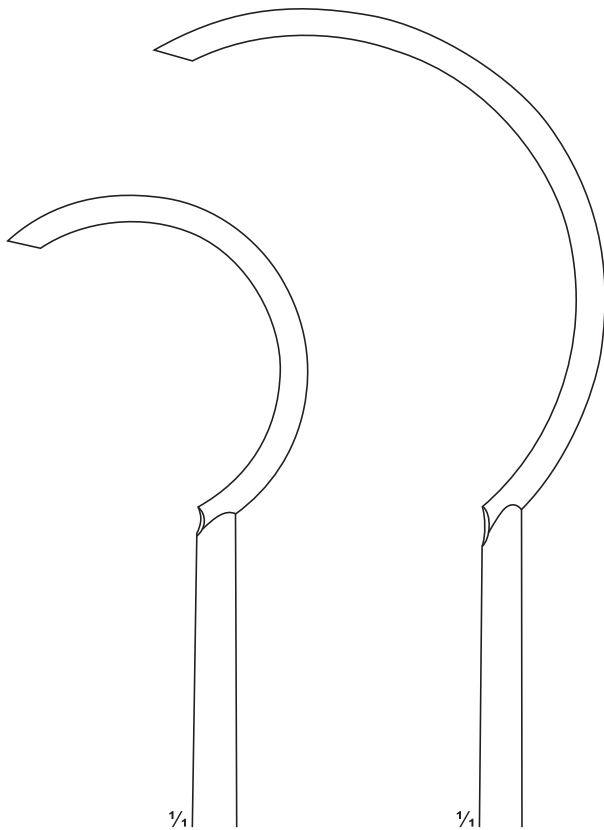

06-8615
240 mm

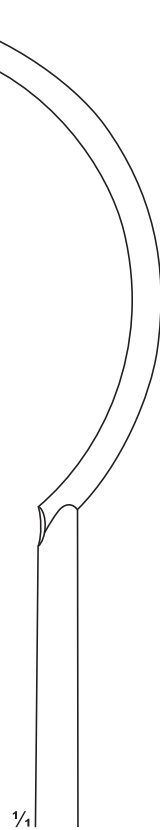

06-8616
270 mm

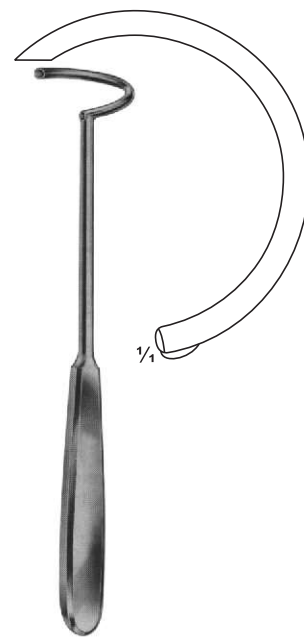

06-8617
225 mm

JORDAN instruments for subcutaneous Tibia Cerclage

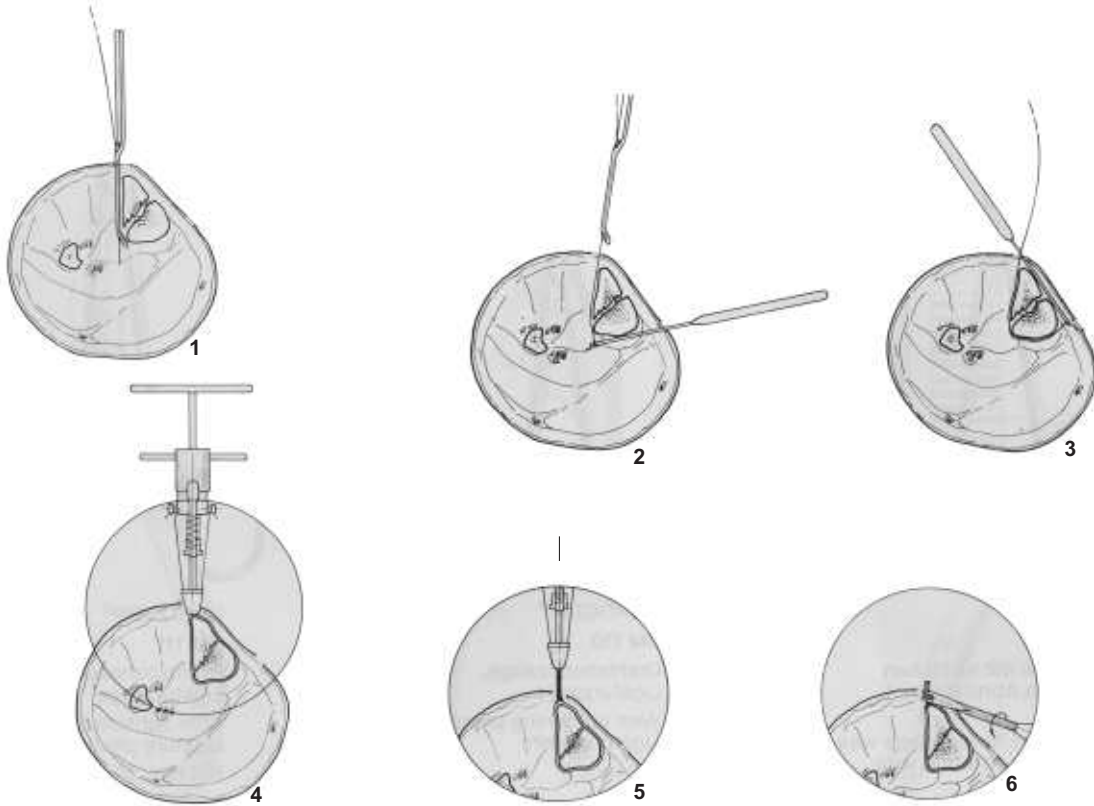

06-8618
JORDAN
Wire tightener



06-8619
JORDAN
Wire twister
170 mm



06-8620
JORDAN
Wire catcher
180 mm



06-8621
JORDAN
Probe, cannulated
170 mm

Wire Holding forceps, Wire Tightening Pliers, Flat-nosed Pliers DUROGRIP with Hard Metal Inserts



06-8622
DUROGRIP
Holding forceps for cerclage wire, with lateral jaws to avoid wire slipping off
170 mm



06-8623
DUROGRIP
Wire, tightening pliers,
Ligature pliers
150 mm



06-8624
DUROGRIP
Wire, tightening pliers,
Ligature pliers
150 mm



06-8625
with serrated jaws
140 mm

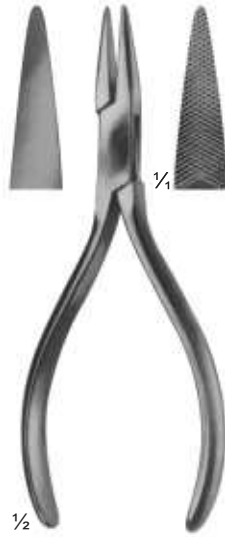

06-8626
one jaw smooth,
one jaw serrated
140 mm



06-8627
with serrated jaws
06-8628
with longitudinal and
transversal grooves
170 mm



06-8629
190 mm

Wire Holding forceps, Flat-nosed Pliers, Pliers for bending and cutting wires

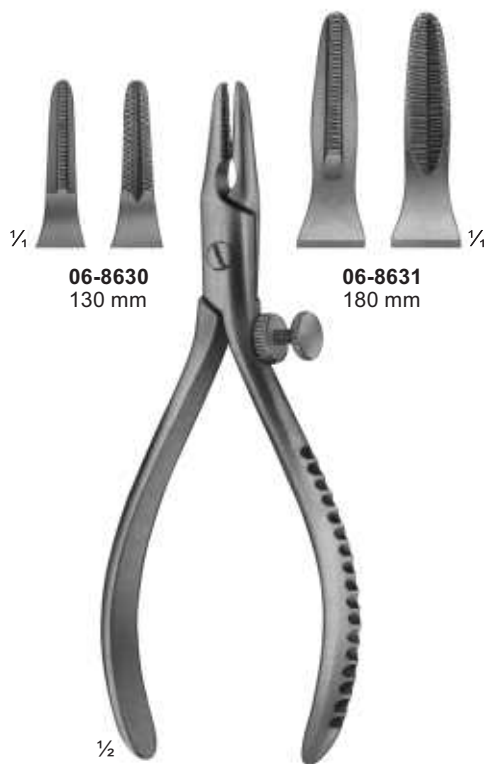

06-8630
130 mm

06-8631
180 mm

06-8630 - 06-8631
Extraction pliers
for boring wires

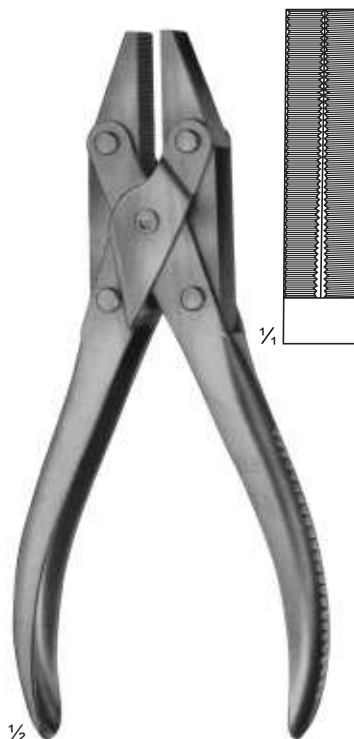

06-8632
Flat-nosed pliers,
parallel
185 mm

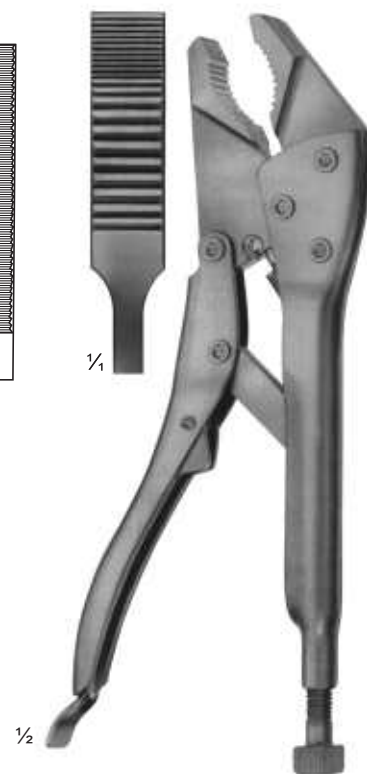

06-8633
Vise grip
200 mm

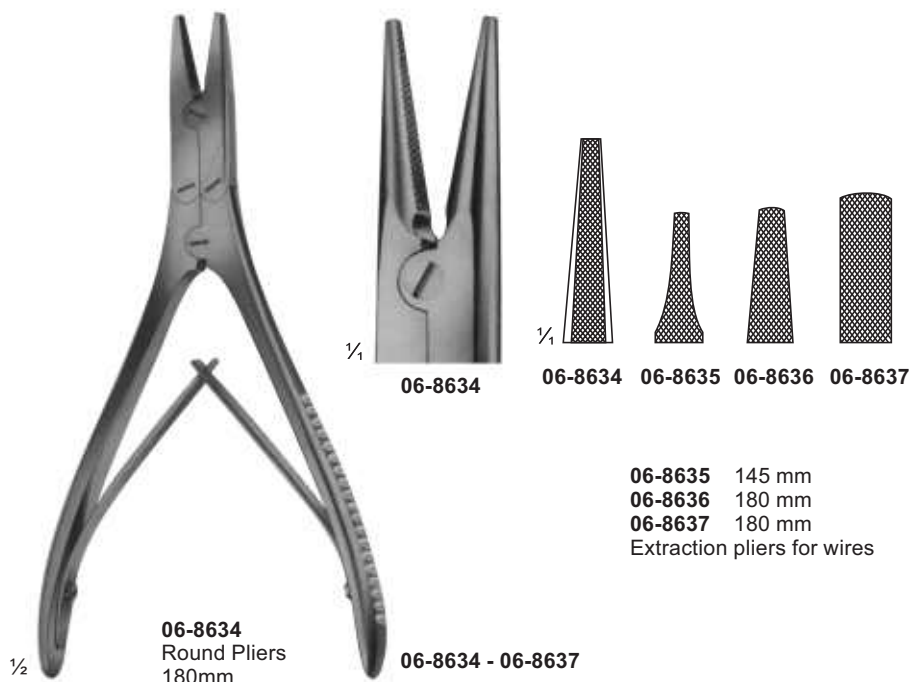

06-8634
Round Pliers
180mm

06-8634 - 06-8637

06-8635 145 mm
06-8636 180 mm
06-8637 180 mm
Extraction pliers for wires



06-8638
Bending pliers
for wires up to
1.8 mm diam.

Wire Cutters and wire Cutting Scissors DUROTIP with Carbide Cutting Edges



06-8639
ANGLE
130 mm

for soft wire
up to diam.
for hard wire
up to diam.

0,5 mm
0,3 mm

06-8640
DUROTIP
ANGLE
130 mm

0,6 mm
0,4 mm

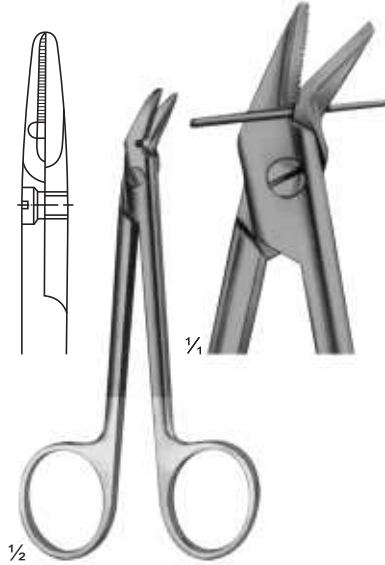

06-8641
120 mm

for soft wire
up to diam.
for hard wire
up to diam.

1,2 mm
0,8 mm

06-8642
DUROTIP
120 mm

1,2 mm
0,8 mm

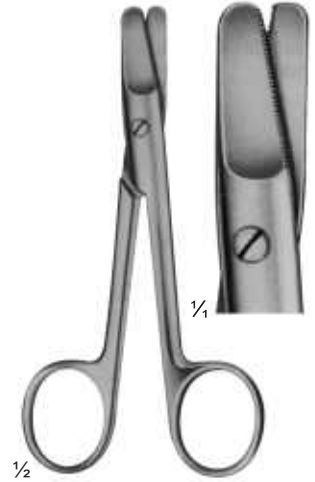

06-8643
HARVEY
125 mm

0,4 mm
0,3 mm



06-8644
150 mm

for soft wire
up to diam
for hard wire
up to diam

1,5 mm
1,0 mm



06-8645
160 mm

1,5 mm
1,2 mm



06-8646
140 mm
DUROTIP
1,5 mm

1,0 mm

Wire Cutting Pliers, Lateral Cutting Action



06-8647
180 mm

for soft wire
up to diam. 2,0 mm
For hard wire 1,5 mm
up to diam
specially hardened
cutting edges, front
and lateral cutting
action



06-8648
REILL
175 mm

for soft wire
up to diam. 2,0 mm
For hard wire 1,6 mm
up to diam
specially hardened
cutting edges, for
cutting off wires close
to the bone



DUROTIP

06-8649
235 mm

for soft wire
up to diam. 3,0 mm
For hard wire 2,2 mm
up to diam

Wire Cutting Pliers, Lateral and Front Cutting Action



06-8650
240 mm

for soft wire
up to diam. 2,0 mm
For hard wire
up to diam 1,6 mm



06-8651
145 mm

for soft wire
up to diam. 1,5 mm
For hard wire
up to diam 1,0 mm



06-8652
145 mm

for soft wire
up to diam. 2,0 mm
For hard wire
up to diam 1,5 mm



06-8653
220 mm

for soft wire
up to diam. 3,5 mm
For hard wire
up to diam 2,5 mm

Wire Cutting Pliers



06-8654
320 mm

for soft wire up to diam. 3,0 mm
For hard wire up to diam 3,0 mm



Cutter for cutting off KIRSCHNER wires, Tibia head screws, bolts, pins, up to 3 mm diam.



DUROTIP

06-8655
Cutter for cutting off KIRSCHNER wires, Tibia head screws, bolts, pins, up to 6 mm diam. 470 mm

Finger Nail Instruments

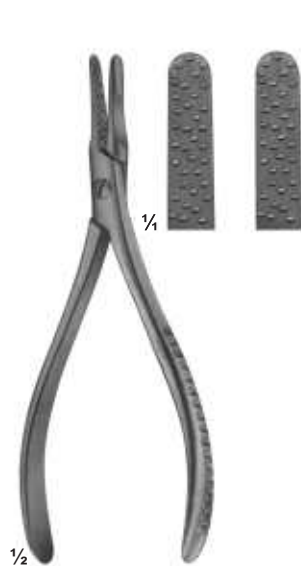

06-8656
Nail extracting
forceps
135 mm



06-8657
Nail extracting
forceps
145 mm



06-8658
Finger nail drill
with 3 drill points

06-8659 06-8660 06-8661
Drill points only

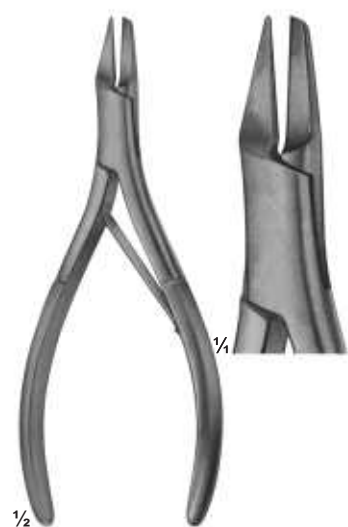

06-8662
Nail splitting
forceps
135 mm



06-8663
SYSTRUNK
Scissors, for splitting
finger nails
130 mm



06-8664
Finger ring saw
150 mm

Spare blade
06-8665

Plaster Instruments

Plaster Knives



with ebony handle

07-9001
HOPKINS
200 mm



07-9002
ESMARCH
180 mm

Plaster Saw



07-9003
ENGEL
160 mm

Bandage and First-Aid scissors



07-9004 - 07-9012 145mm

- | | | | |
|---------|-------------|---------|-------------|
| 07-9004 | black | 07-9008 | yellow |
| 07-9005 | red | 07-9009 | white |
| 07-9006 | blue | 07-9010 | orange |
| 07-9007 | light green | 07-9011 | violet |
| | | 07-9012 | bright pink |



07-9013 - 07-9021 180mm

- | | | | |
|---------|-------------|---------|-------------|
| 07-9013 | black | 07-9017 | yellow |
| 07-9014 | red | 07-9018 | white |
| 07-9015 | blue | 07-9019 | orange |
| 07-9016 | light green | 07-9020 | violet |
| | | 07-9021 | bright pink |

Plaster Scissors

For small plaster dressings



07-9022
160 mm

1/2



07-9023 - 07-9024
ESMARCH
07-9023 200mm
07-9024 230mm

1/2



07-9025
BERGMANN
230 mm

1/2



07-9026
BRUNS
235 mm

1/2



07-9027
235 mm

1/2

also to be used as
bandage scissors

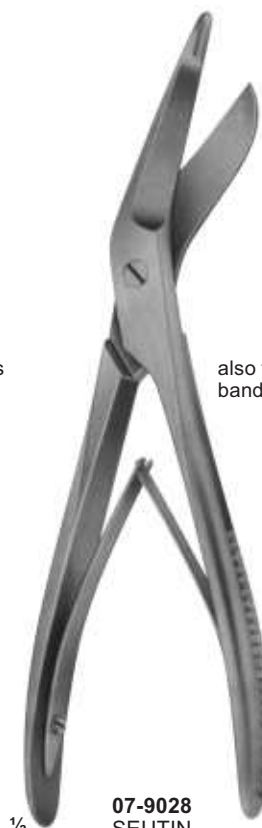

07-9028
SEUTIN
230 mm

1/2

also to be used as
bandage scissors

Plaster Shears

Special features:

The construction of the open jaws avoids tiresome clogging by plaster remnants and allows furthermore an easy cleaning. The shears do not glide off the plaster owing to the deep teething on the jaws. The knives with hollow grinding have a better cutting ability and therefore less force is required. The knives are guided by ball bearings.

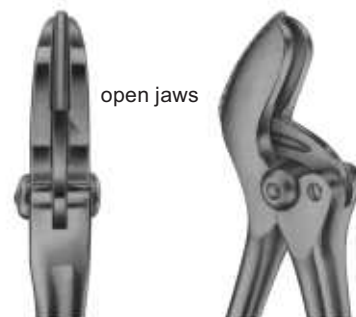

open jaws



07-9029A

Spare blade

open jaws

1/2

07-9029
STILLE
260 mm



07-9031

Spare blade

open jaws

1/2

07-9030
STILLE
360 mm

STILLE Plaster Shears

Blade with reinforced back



1/3

07-9032
STILLE
230 mm

07-9033
Spare blade



1/3

07-9034
STILLE
370 mm

07-9035
Spare blade



1/3

07-9036
STILLE
240 mm

07-9037
Spare blade

Plaster Spreader, Plaster Breakers



07-9038
HENNIG
270 mm



07-9039
MOD.USA
230 mm



07-9040
290 mm



with removable jaws



07-9041 - 07-9042
WOLFF
07-9041 180 mm
07-9042 240 mm
plaster breakers

Vacuum Currettes for Aspiration Lipectomy, Suction Instuments

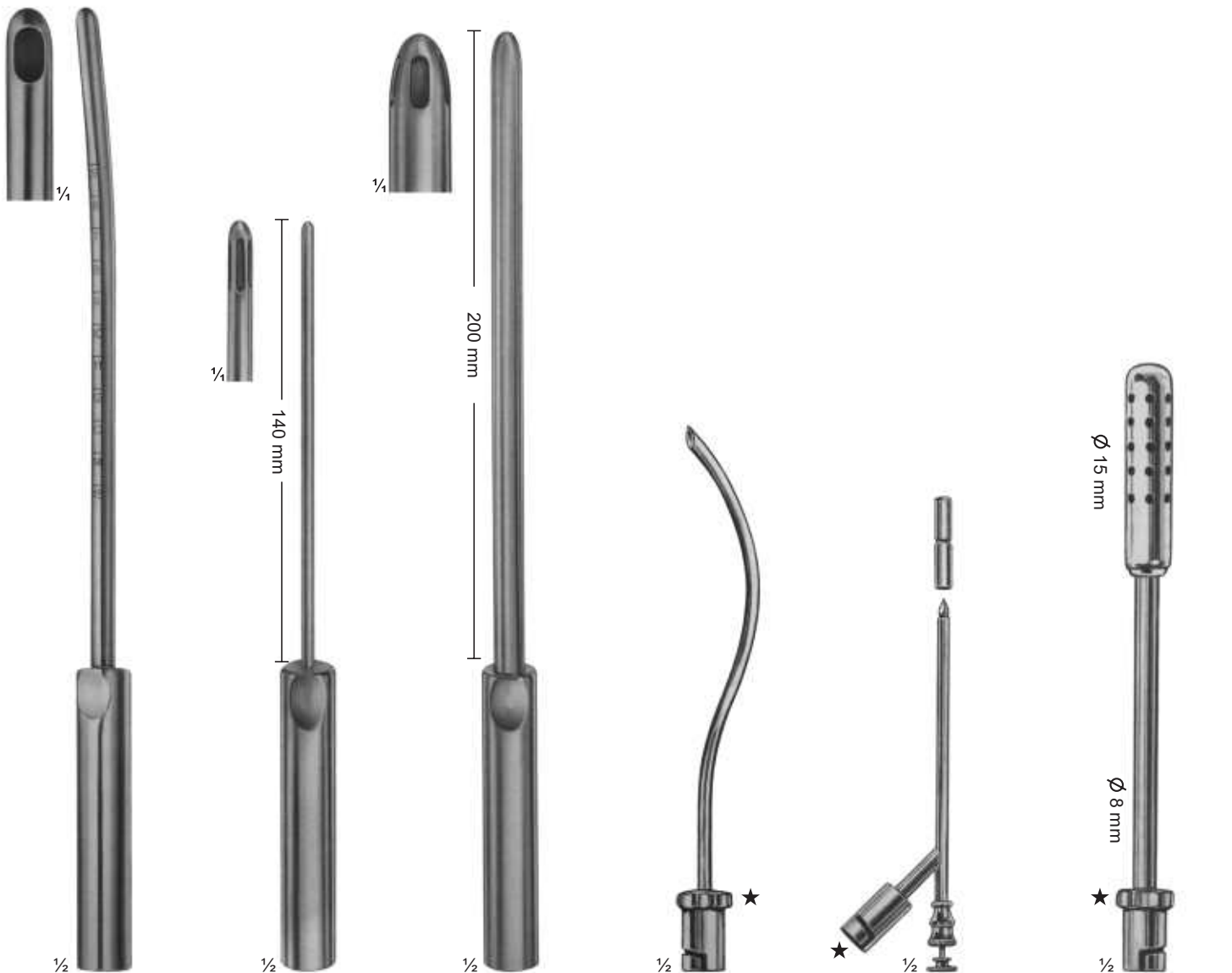

07-9043 - 07-9048
BIEMER
07-9043 ø4mm
07-9044 ø6mm
07-9045 ø8mm
07-9046 ø10mm
07-9047 ø12mm
07-9048 ø14mm
 Currettes for aspiration lipectomy, graduated, slightly curved

07-9049 - 07-9050
BIEMER
07-9049 ø4 mm
07-9050 ø6 mm
 Currettes for aspiration lipectomy, with three apertures, slightly curved malleable

07-9051 - 07-9053
BIEMER
07-9051 ø 8 mm
07-9052 ø10 mm
07-9053 ø12 mm
 Currettes for aspiration lipectomy, with three apertures, slightly curved malleable

07-9054
For aspirating fluid from the excretory ducts of large glands and for keeping the operating area clear
170 mm

07-9055
Trocar
For puncturing
150 mm

07-9056
For clearing large quantities of fluid
190 mm

Suction Instruments

07-9057 150mm
Suction handle, with vacuum regulator and finger cut-off, brass, mirror-finish chromium-plated



olive
Ø9 mm

07-9058 170mm
Suction handle, with hand regulation valve and quick-shutter, brass, mirror-finish chromium-plated



★ Both suction handles have bayonet fitting olive and can be used for the suction cannulae. Ø9 mm



07-9059
Trocar
For puncturing
170 mm



07-9060
Hollow needle, sharp
150 mm



07-9061
double curved
For general surgery
230 mm



07-9062
For tonsillectomy, oral and laryngeal operations
190 mm



07-9063
For tonsillectomy, oral and laryngeal operations
220 mm

★ With bayonet fitting to be used with suction handles (07-9057 - 07-9058)

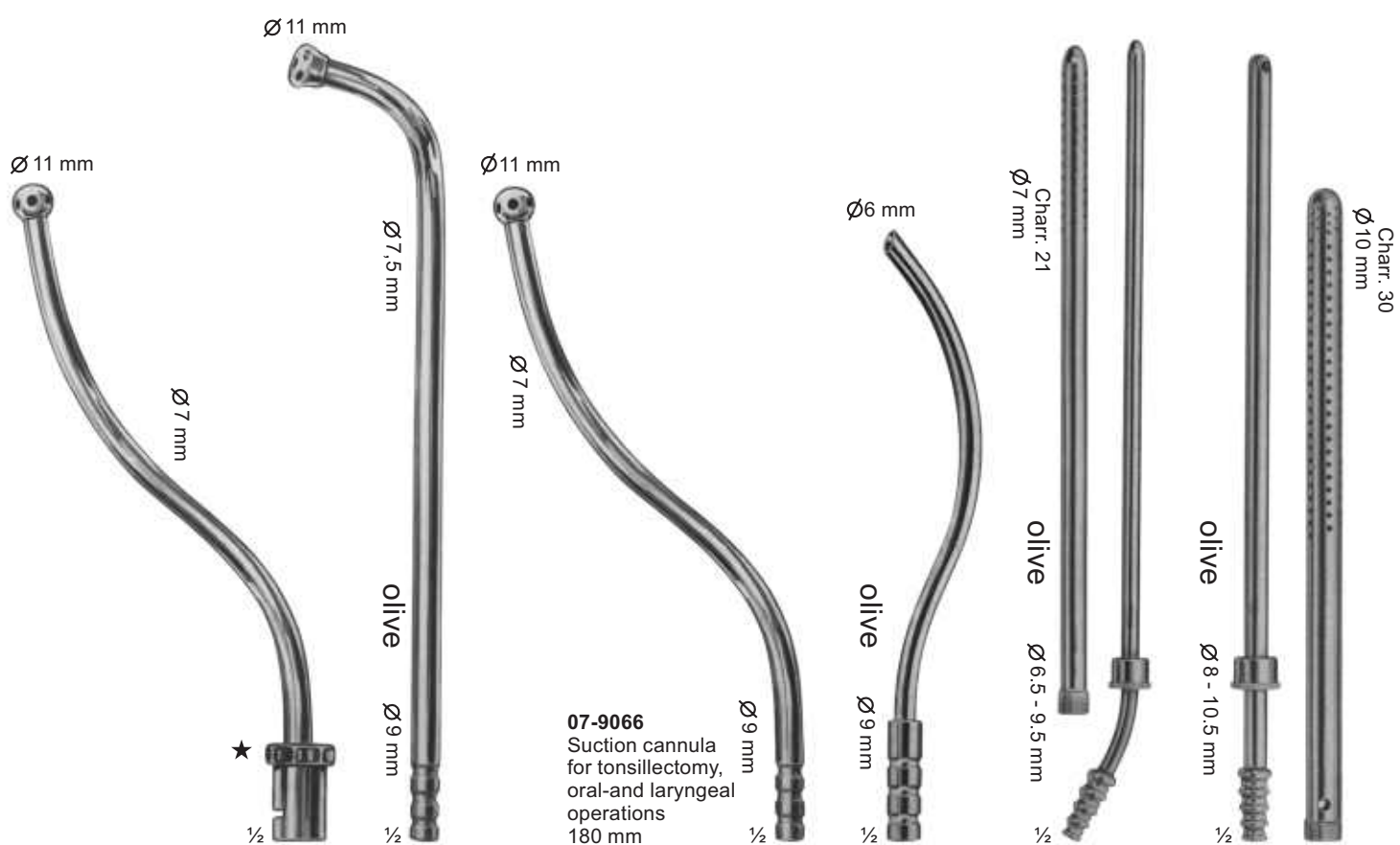

07-9064
For tonsillectomy,
oral-and laryngeal
operations
180 mm

07-9065
Suction cannula
for tonsillectomy,
oral-and laryngeal
operations
220 mm

07-9066
Suction cannula
for tonsillectomy,
oral-and laryngeal
operations
180 mm

07-9067
S-shaped blunt cannula
for aspirating fluid from
the excretory ducts of
large glands and for
keeping the operating
area clear
170 mm

07-9068
POOL
Suction cannula,
with outer tube
to be screwed of
225 mm

07-9069
POOL
Suction cannula,
with outer tube
to be screwed off
225 mm

Suction Instruments



olive
Ø6-9 mm

1/2

- 07-9076 Ø1,5 mm
- 07-9077 Ø2,0 mm
- 07-9078 Ø2,5 mm
- 07-9079 Ø3,0 mm

07-9076 - 07-9079
PLESTER
with finger cut-off and
stylet, thumb piece
parallel to curve, with
LUER hub
195 mm

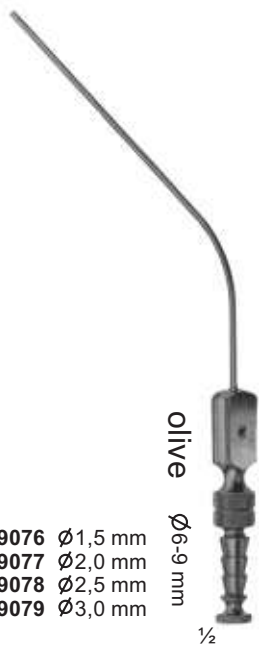

olive
Ø6-9 mm

1/2

- 07-9080 Ø2,0 mm
- 07-9081 Ø2,5 mm
- 07-9082 Ø3,0 mm
- 07-9083 Ø4,0 mm
- 07-9084 Ø5,0 mm

07-9080 - 07-9084
FERGUSSON
with finger cut-off and
stylet, thumb piece
90° to curve, with
LUER hub
180 mm



olive
Ø6-9 mm

1/2

07-9085 Ø4mm
FERGUSSON
insulated, with finger cut-off
and stylet, thumb piece 90°
to curve, with LUER hub
180 mm



olive
Ø6-9 mm

1/2

07-9086 Ø3mm
07-9087 Ø5mm
FRAZIER
with finger
cut-off and stylet, thumb
piece 90° to curve,
with LUER hub
180 mm

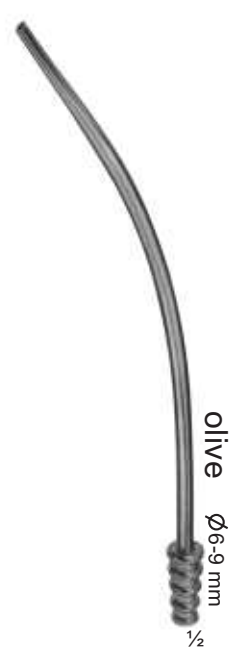

olive
Ø6-9 mm

1/2

07-9088
5,0 mm diam., Tip
6,5 mm wide, Nasal
suction tube, with
LUER hub
180 mm



1/2

07-9089 4,Ømm
07-9090 5,Ømm
Nasal suction
tubes
175 mm



1/2

07-9091
GORNEY
Suction dissector
180 mm



olive

Ø6-10 mm

1/2

07-9092 4 mm wide
07-9093 5 mm wide
Suction raspatories,
sharp, bayonet-shaped,
with stylet
200 mm



olive

Ø9 mm

1/2

07-9094
LOPEZ-REINKE
Tonsil dissector with
suction device
235 mm

Suction Instruments

07-9095
WULLSTEIN
Suction tube, conical, silver, olive
with LUER hub
160 mm

Ø1,75 mm

olive Ø3 mm
1/2
Ø8 mm



07-9096 1,5 mm
07-9097 2,0 mm
WULLSTEIN
Suction tube, cylindrical, silver, with
stylet olive with LUER hub
160 mm

olive Ø8 mm
1/2



Usable length

YASARGIL usable length diam.		YASARGIL usable length diam.	
07-9098	130 mm 1,5 mm	07-9106	130 mm 2,5 mm
07-9099	150 mm 1,5 mm	07-9107	150 mm 2,5 mm
07-9100	180 mm 1,5 mm	07-9108	180 mm 2,5 mm
07-9101	220 mm 1,5 mm	07-9109	220 mm 2,5 mm
07-9102	130 mm 2,0 mm	07-9110	130 mm 3,5 mm
07-9103	150 mm 2,0 mm	07-9111	150 mm 3,5 mm
07-9104	180 mm 2,0 mm	07-9112	180 mm 3,5 mm
07-9105	220 mm 2,0 mm	07-9113	220 mm 3,5 mm
		07-9114	180 mm 4,5 mm

olive
Ø6,5-9 mm
with LUER hub

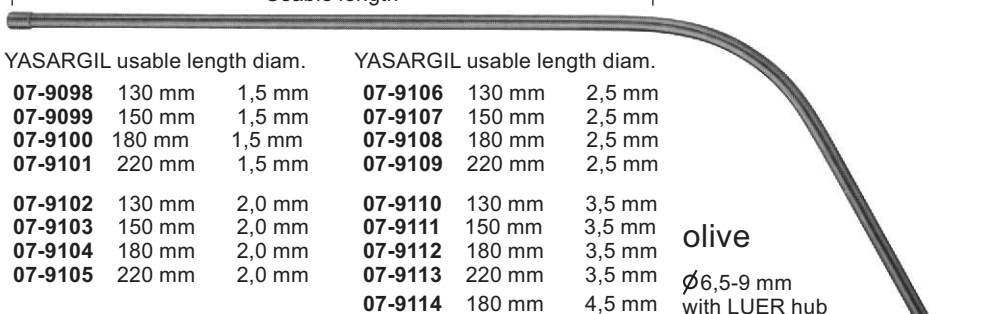

07-9115 - 07-9117
LANDOLT
150 MM
diam Ø3 mm

07-9115 8 mm / curved
07-9116 11mm / curved
07-9117 15mm / curved

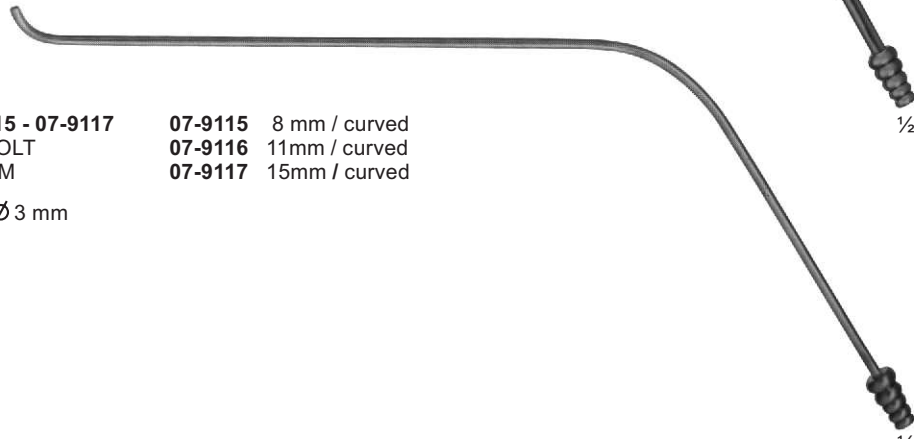

Ø3.5 mm

Ø2.0 mm

07-9118 500 mm
07-9119 350 mm
with rubber tip,
with LUER hub

olive Ø9 mm
1/2

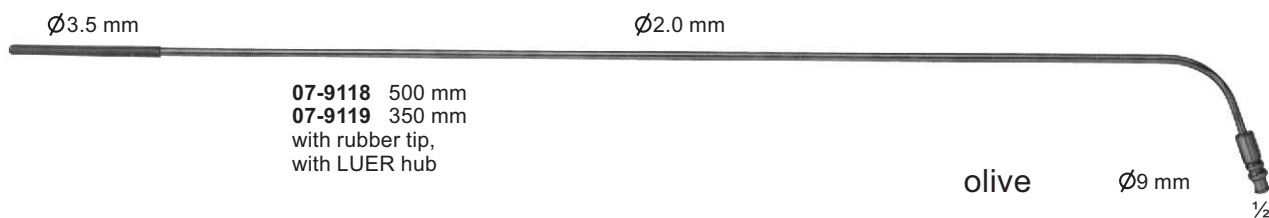

07-9120 2,0 mm diam
07-9121 2,5 mm diam
07-9122 3,0 mm diam
with finger cut-off,
thumb piece 90° to
curve, with LUER hub
250 mm

olive Ø6-9 mm
1/2



Combined Suction and Irrigation Cannulae, Coagulation Suction Cannulae

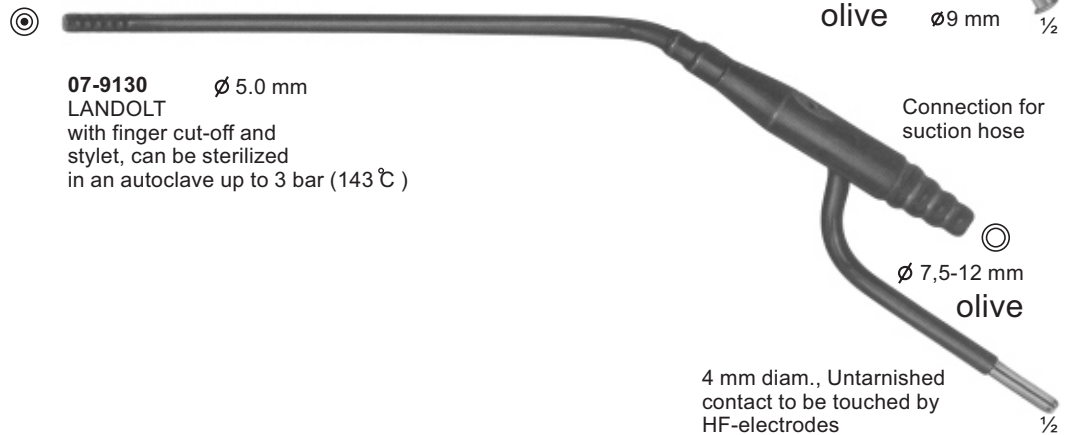
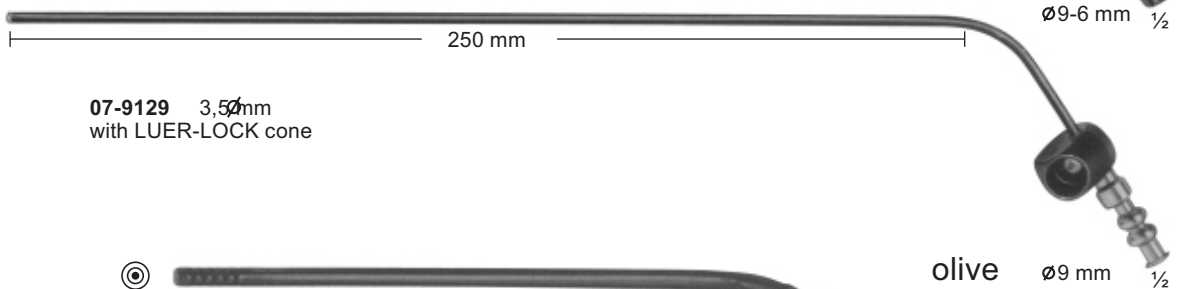
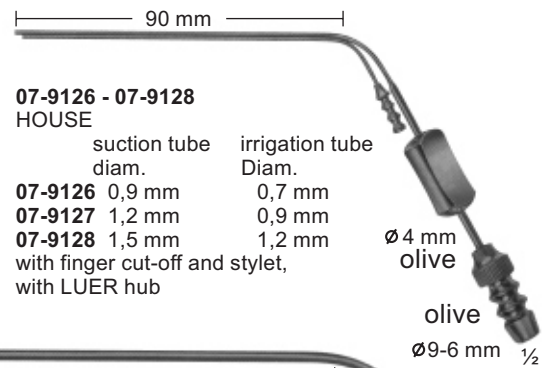
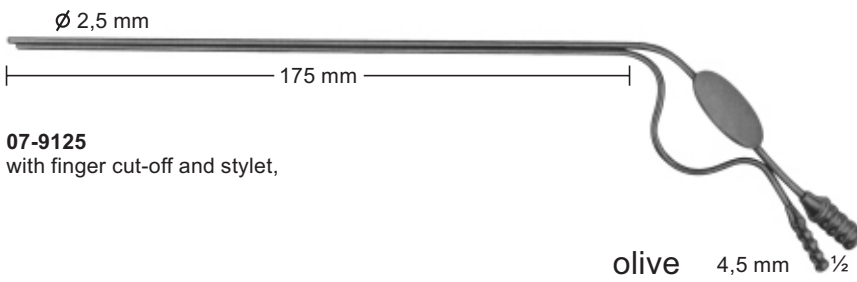

Scissors with Tungsten Carbide Inserts

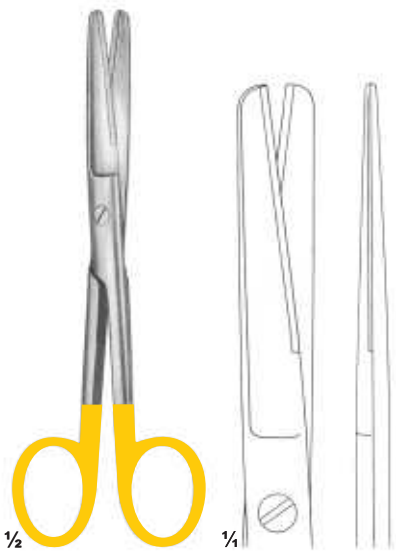

07-9131 - 07-9133
STANDARD

- 07-9131** 14,5cm
- 07-9132** 16,5cm
- 07-9133** 18,5cm

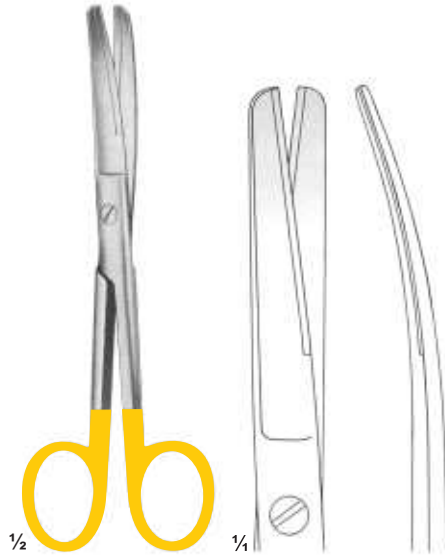

07-9134 - 07-9136
STANDARD

- 07-9134** 14,5cm
- 07-9135** 16,5cm
- 07-9136** 18,5cm



07-9137 - 07-9139
STANDARD

- 07-9137** 14,5cm
- 07-9138** 16,5cm
- 07-9139** 18,5cm



07-9140 - 07-9142
STANDARD

- 07-9140** 14,5cm
- 07-9141** 16,5cm
- 07-9142** 18,5cm

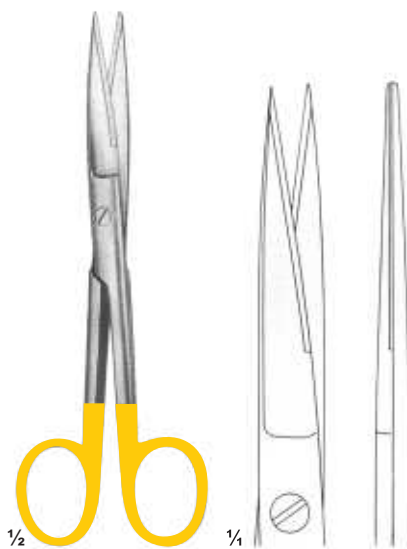

07-9143 - 07-9145
STANDARD

- 07-9143** 14,5cm
- 07-9144** 16,5cm
- 07-9145** 18,5cm



07-9146 - 07-9148
STANDARD

- 07-9146** 14,5cm
- 07-9147** 16,5cm
- 07-9148** 18,5cm

Scissors with Tungsten Carbide Inserts

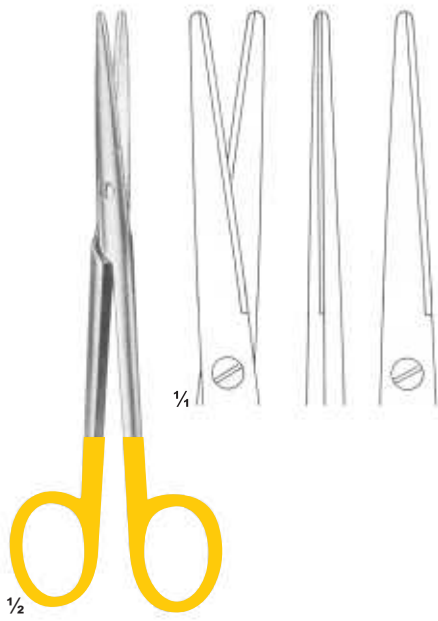

07-9149
MAYO-LEXER
16cm

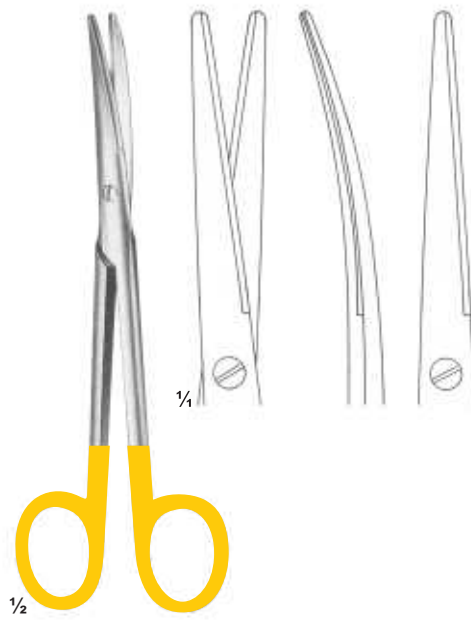

07-9150
MAYO-LEXER
16cm



07-9151 - 07-9152
LEXER

07-9151 16cm
07-9152 21cm

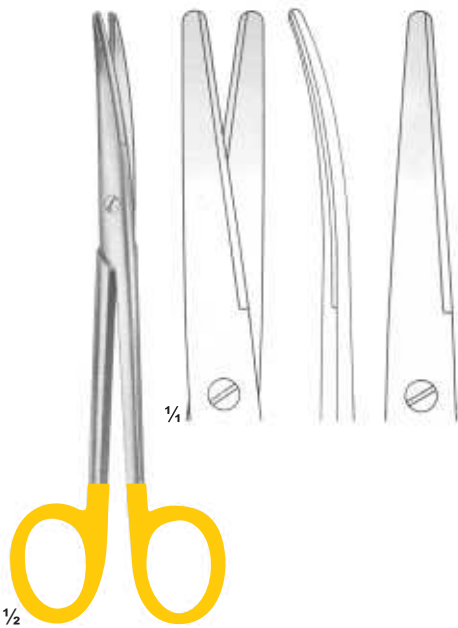

07-9153 - 07-9154
LEXER

07-9153 16cm
07-9154 21cm

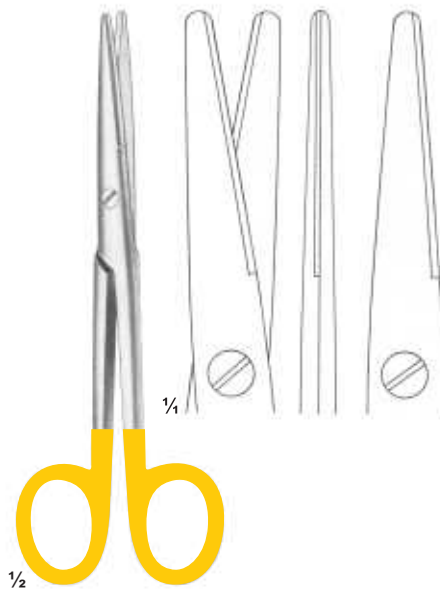

07-9155 - 07-9156
MAYO-STILLE

07-9155 15cm
07-9156 17cm

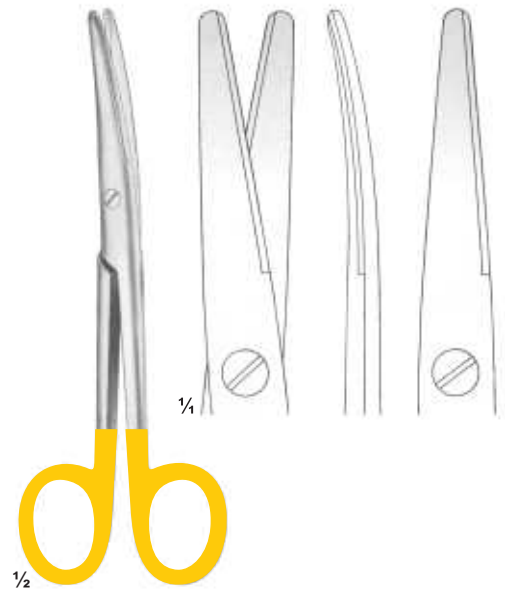

07-9157 - 07-9158
MAYO-STILLE

07-9157 15cm
07-9158 17cm

Scissors with Tungsten Carbide Inserts

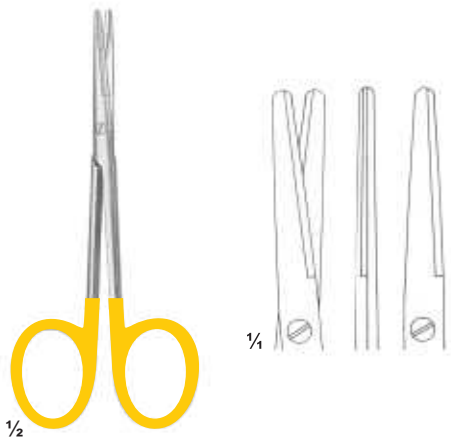

07-9159 - 07-9160
METZENBAUM

07-9159 11.5cm
07-9160 14.5cm



07-9161 - 07-9164
METZENBAUM

07-9161 11.5cm
07-9162 14.5cm
07-9163 23cm
07-9164 25cm



07-9165 - 07-9170
METZENBAUM

07-9165 18cm
07-9166 20cm
07-9167 23.5cm
07-9168 25.5cm
07-9169 28cm
07-9170 30cm

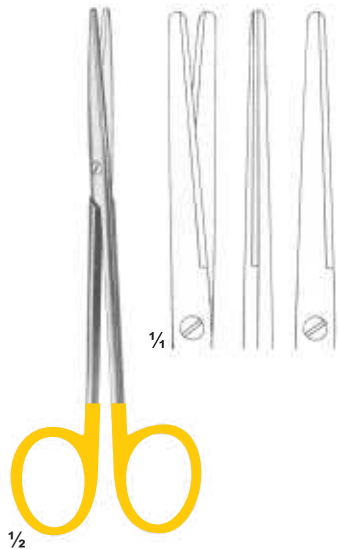

07-9171 - 07-9176
METZENBAUM-FINO

07-9171 14cm
07-9172 18cm
07-9173 20cm
07-9174 23cm
07-9175 25cm
07-9176 28cm

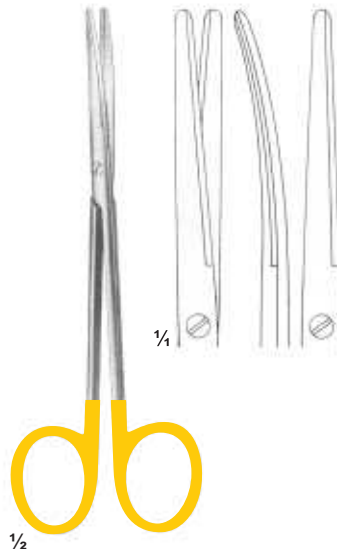

07-9177 - 07-9182
METZENBAUM-FINO

07-9177 14cm
07-9178 18cm
07-9179 20cm
07-9180 23cm
07-9181 25cm
07-9182 28cm

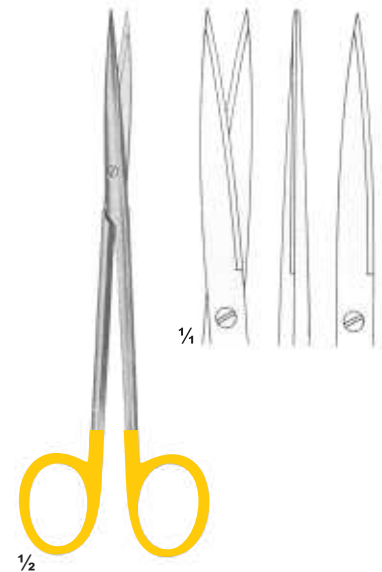

07-9183 - 07-9186
METZENBAUM-FINO

07-9183 14cm
07-9184 18cm
07-9185 20cm
07-9186 23cm

Scissors with Tungsten Carbide Inserts

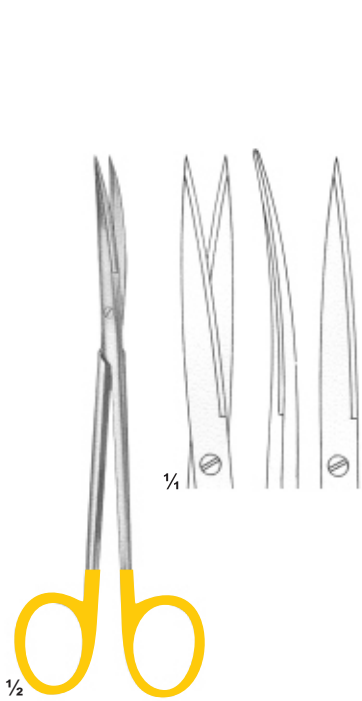

07-9187 - 07-9190
METZENBAUM-FINO

- 07-9187** 14cm
- 07-9188** 18cm
- 07-9189** 20cm
- 07-9190** 23cm

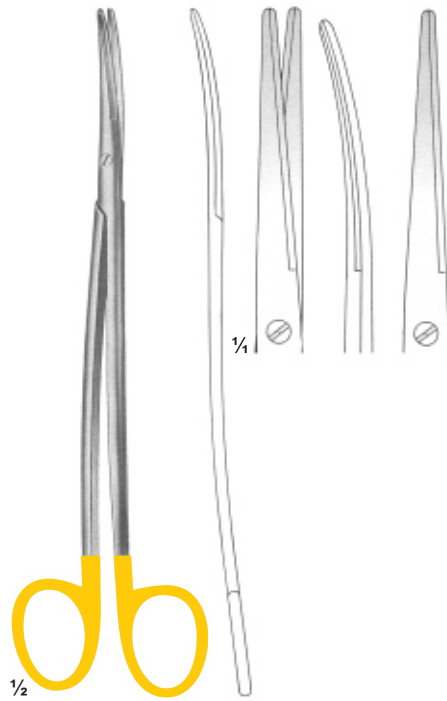

07-9191 - 07-9193
METZENBAUM-FINO

- 07-9191** 18cm
- 07-9192** 20cm
- 07-9193** 23cm

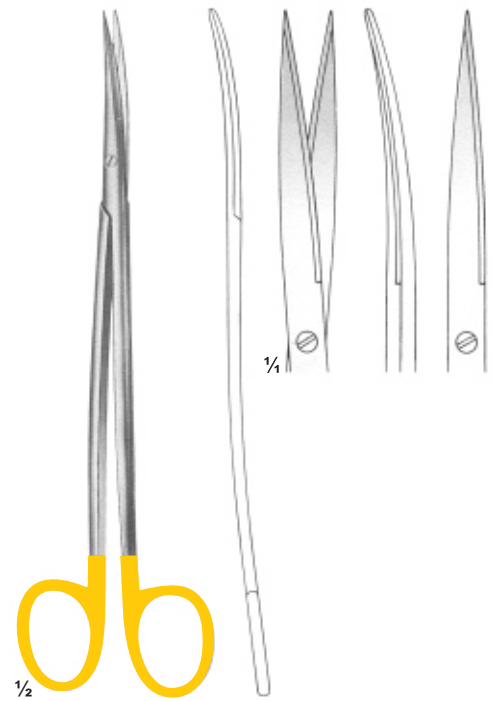

07-9194 - 07-9196
METZENBAUM-FINO

- 07-9194** 18cm
- 07-9195** 20cm
- 07-9196** 23cm

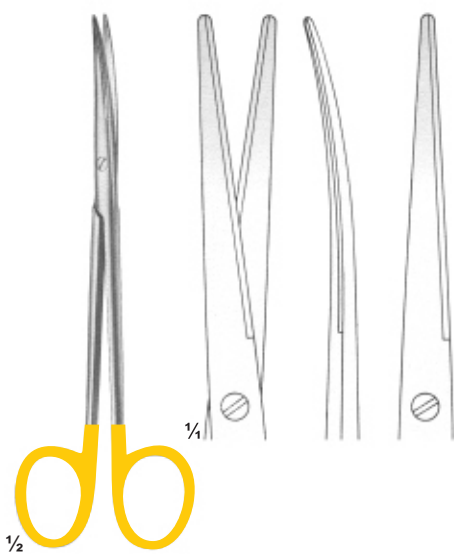

07-9197 - 07-9198
METZENBAUM

- 07-9197** 20cm
- 07-9198** 23cm

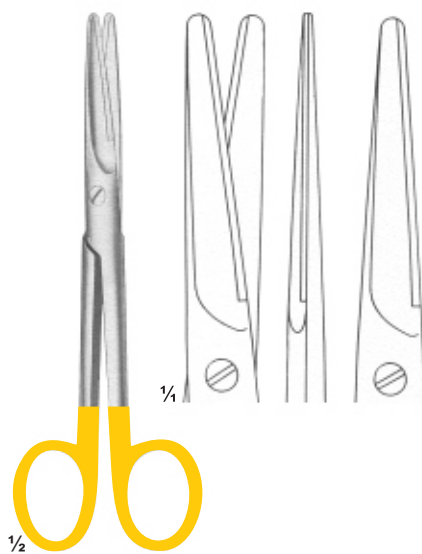

07-9199 - 07-9201
MAYO

- 07-9199** 14.5cm
- 07-9200** 17cm
- 07-9201** 23cm

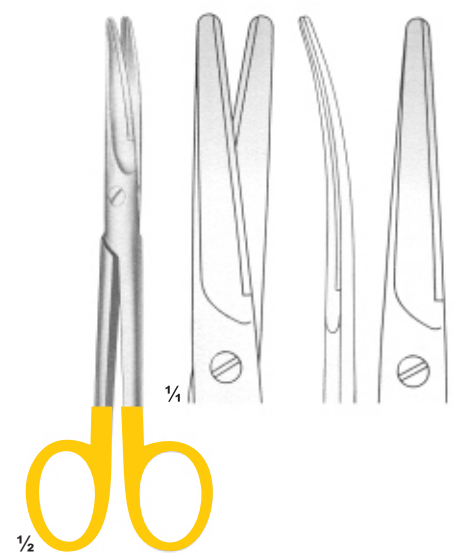

07-9202 - 07-9204
MAYO

- 07-9202** 14.5cm
- 07-9203** 17cm
- 07-9204** 23cm

Scissors with Tungsten Carbide Inserts

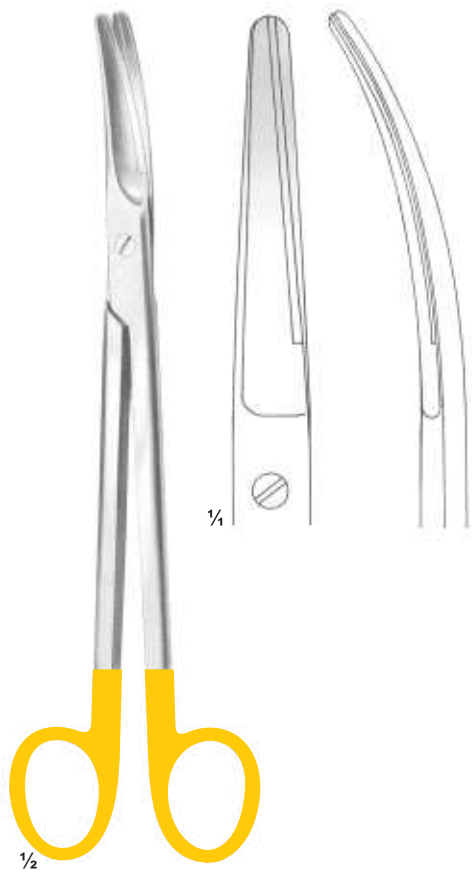

07-9205
WERTHEIM
Dissecting Scissors
23cm

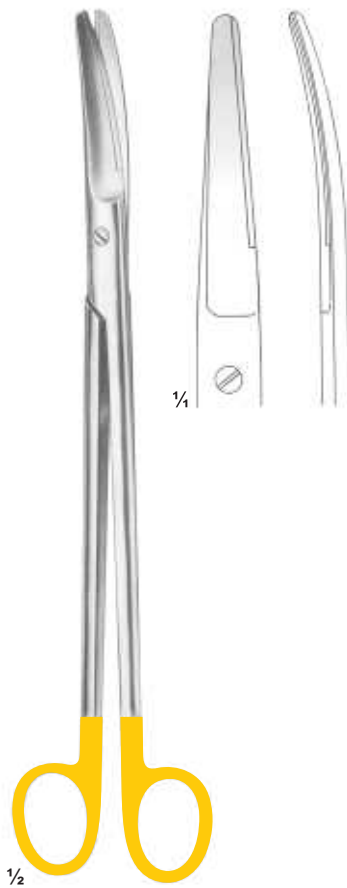

07-9206
SIMS
20cm
07-9207
23cm

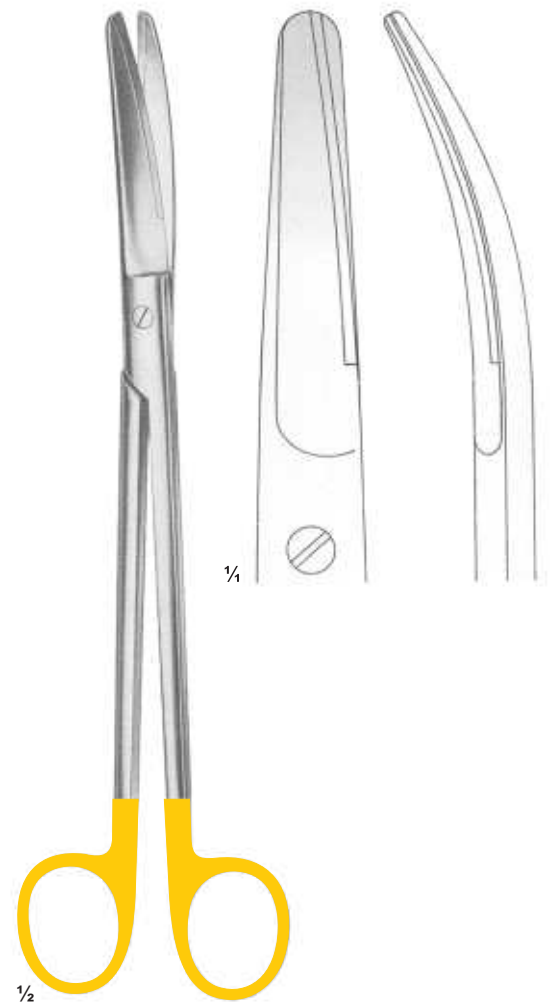

07-9208
MAYO-HARRINGTON
28cm

Scissors with Tungsten Carbide Inserts



07-9209 - 07-9211
DE-BAKEY
(Potts-Smith)

07-9209 23cm 25°
07-9210 23cm 45°
07-9211 23cm 60°



07-9212 - 07-9214 **07-9212** 19cm 25° **07-9215**
DE-BAKEY **07-9213** 19cm 45° GOLDMANN FOX
(Potts-Smith) **07-9214** 19cm 60° 13cm

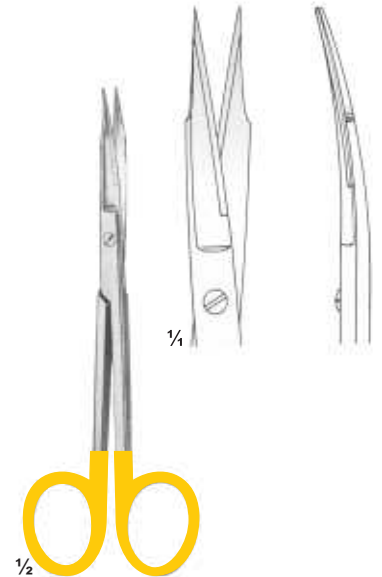
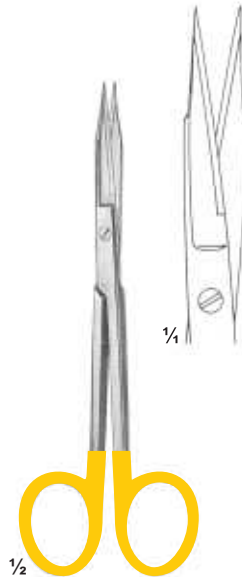

07-9216
GOLDMANN FOX
13cm

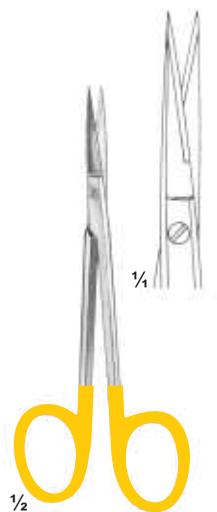

07-9217
Fine Scissor
11,5cm

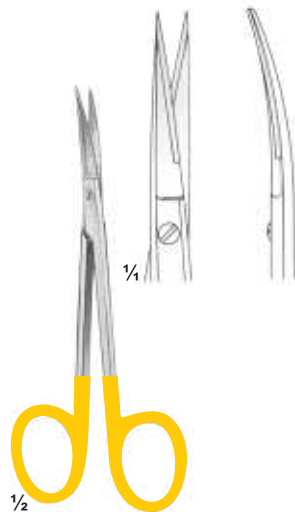

07-9218
Fine Scissor
11,5cm

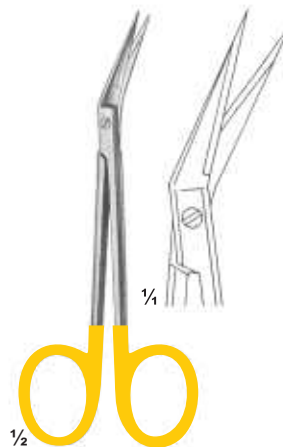

07-9219
11,5cm

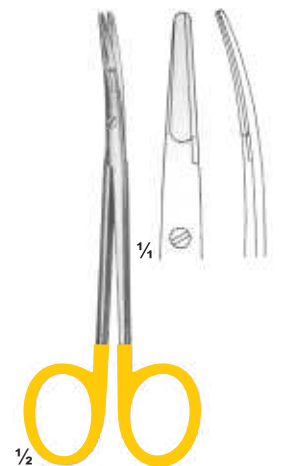

07-9220
RAGNELL (Kilner)
12cm

Scissors & Dissecting Forceps with Tungsten Carbide Inserts

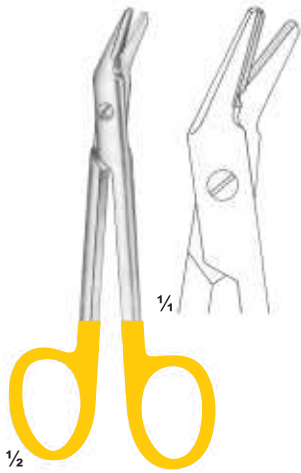

07-9221
UNIVERSAL
12cm



07-9222 - 07-9224
SUTURE SCISSORS
1 Black & 1 Gold Plated ring

07-9222 14cm
07-9223 17cm
07-9224 23cm

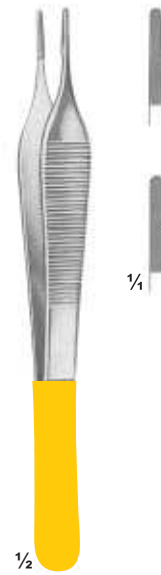

07-9225 - 07-9226 **07-9225** 12cm
ADSON **07-9226** 15cm



07-9227
CUSHING
With dissector end
17,5cm



07-9228
CUSHING
With dissector end
18cm



07-9229
CUSHING-TAYLOR
18cm



07-9230
DISSECTING FORCEPS
15cm



07-9231
SEMKEN
15cm

Dissecting Forceps and Needle holders with Tungsten Carbide Inserts

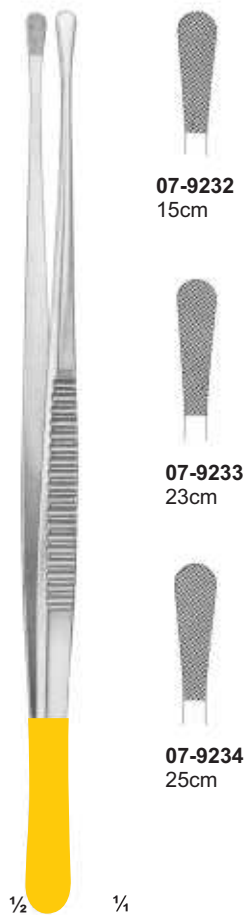

07-9232
15cm

07-9233
23cm

07-9234
25cm

1/2 1/4

07-9232 - 07-9234
WANGENSTEEN

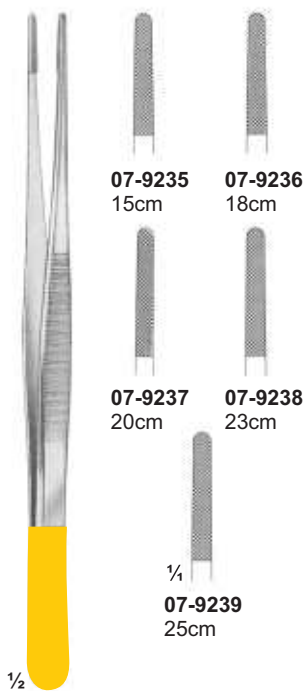

07-9235
15cm

07-9236
18cm

07-9237
20cm

07-9238
23cm

1/4
07-9239
25cm

1/2

07-9235 - 07-9239
POTTS-SMITH

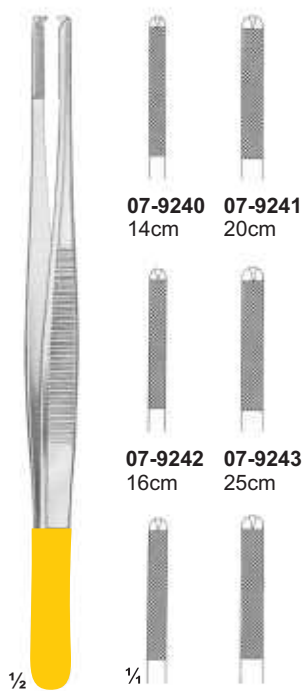

07-9240
14cm

07-9241
20cm

07-9242
16cm

07-9243
25cm

1/4
07-9244
18cm

07-9245
30cm

1/2

07-9240 - 07-9245
OEHLER



1/2

07-9246
POTTS-SMITH
22cm



1/4
Smooth Jaw

1/2

07-9247
HEPP-SCHIEDL
18cm



1/4

1/2

07-9248
CASTROVIEJO
14cm



1/4

1/2

07-9249
CASTROVIEJO
14cm



1/4

1/2

07-9250
ARRUGA
16cm

Needle holders with Tungsten Carbide Inserts

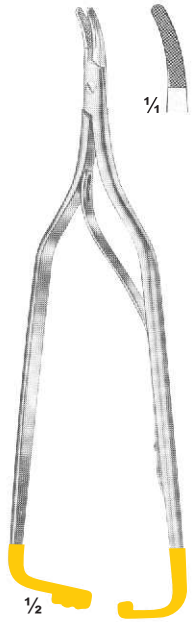

07-9251
ARRUGA
16cm

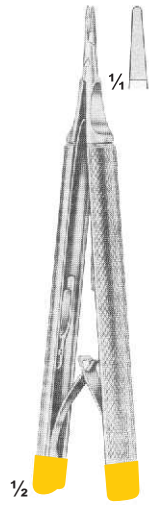

07-9252
CASTROVIEJO
13cm

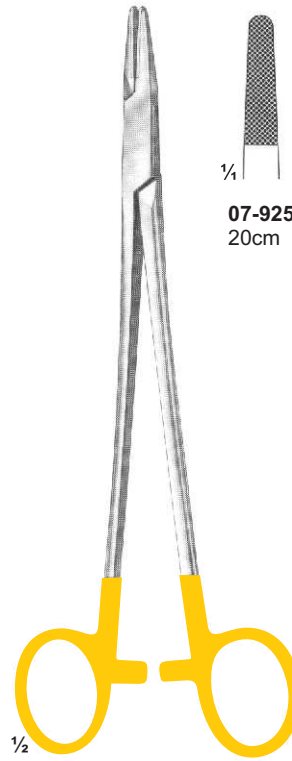

07-9253 - 07-9254
HEGAR

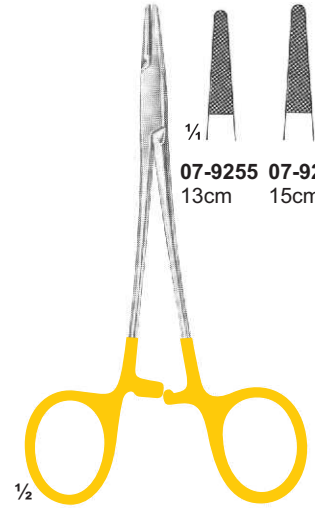
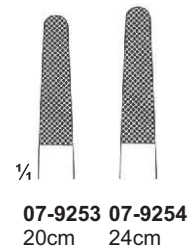

07-9255 - 07-9256
HALSEY

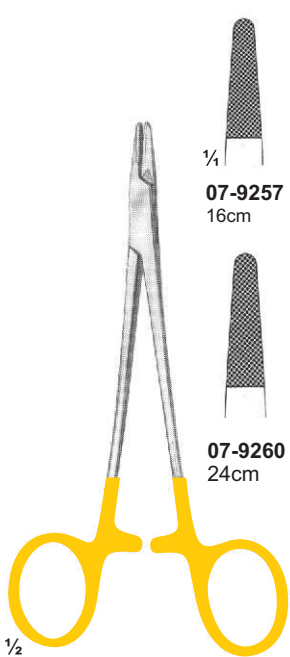
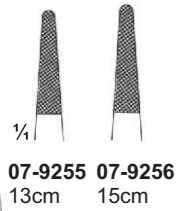

07-9257 - 07-9262
MAYO-HEGAR

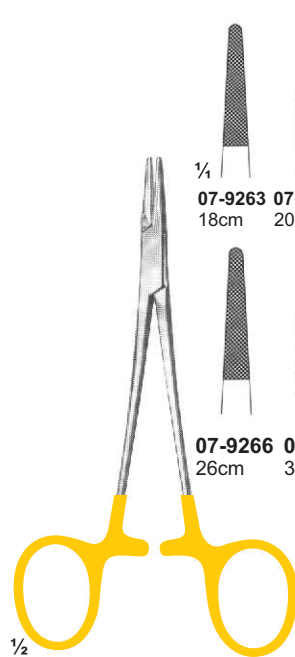
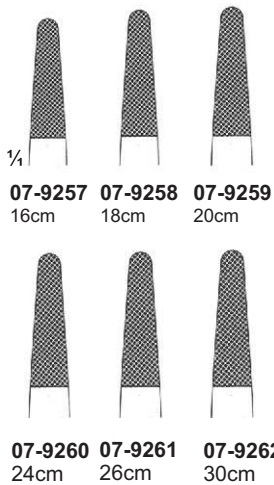

07-9263 - 07-9268
DE-BAKEY

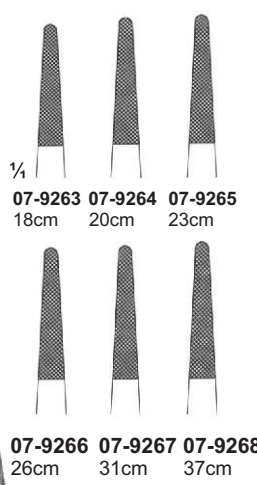

07-9269 - 07-9272
HEGAR-VASCULAR

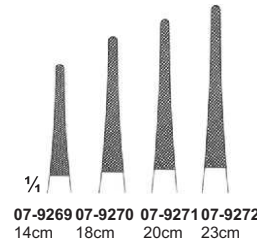

Needle holders with Tungsten Carbide Inserts

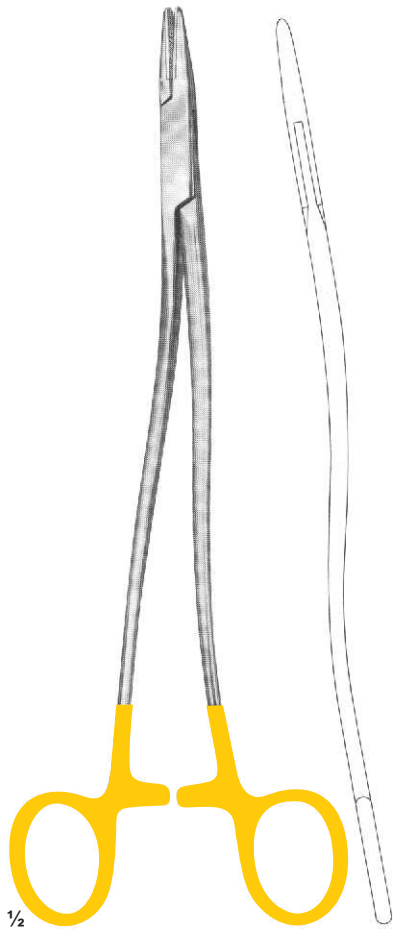

07-9273 - 07-9275
BOZEMANN

07-9273 20cm
07-9274 24cm
07-9275 26cm

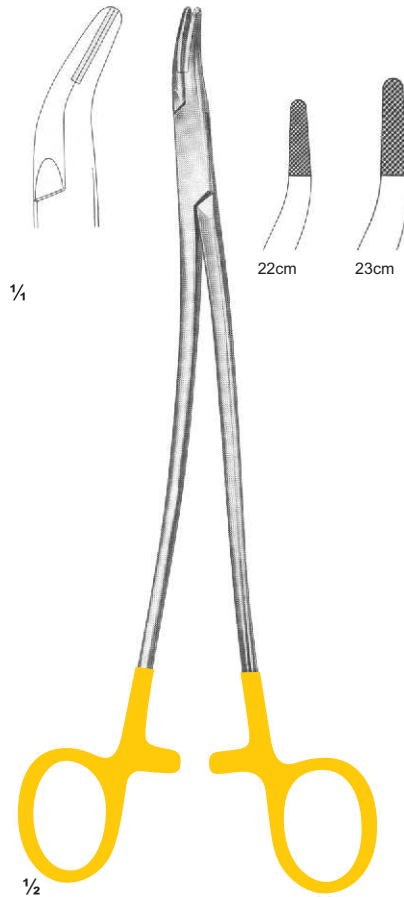

07-9276 - 07-9277
STRATTE

07-9276 22cm
07-9277 23cm

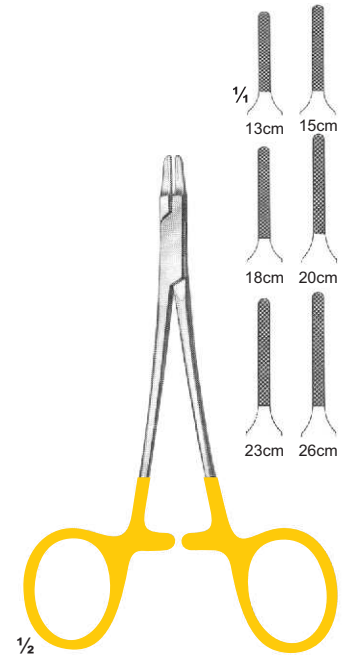

07-9278 - 07-9283
RYDER

07-9278 13cm
07-9279 15cm
07-9280 18cm
07-9281 20cm
07-9282 23cm
07-9283 26cm

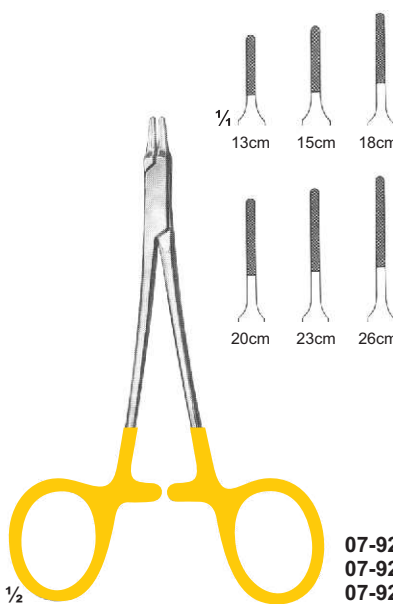

07-9284 - 07-9288
RYDER-VASCULAR

07-9284 13cm
07-9285 15cm
07-9286 20cm
07-9287 23cm
07-9288 26cm

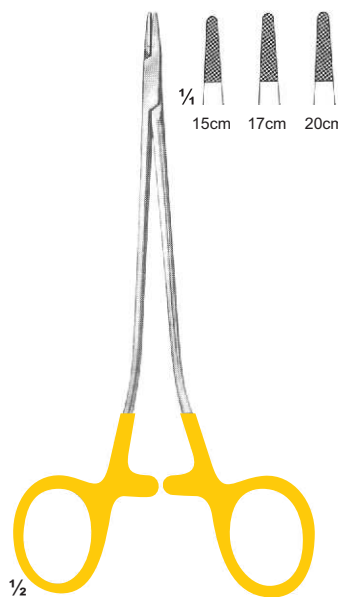

07-9289 - 07-9291
MARTIN

07-9289 15cm
07-9290 17cm
07-9291 20cm

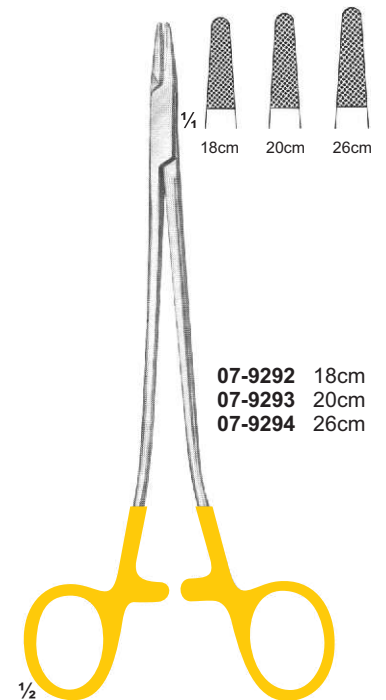

07-9292 - 07-9294
SAROT

07-9292 18cm
07-9293 20cm
07-9294 26cm

Needle holders with Tungsten Carbide Inserts



07-9295
FINOCHIETTO
27cm



07-9296 - 07-9297A
HEANEY
07-9296 20cm
07-9297 24cm
07-9297A 26cm

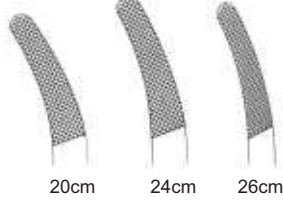

07-9298 - 07-9300
MATHIEU
07-9298 14cm
07-9299 17cm
07-9300 20cm

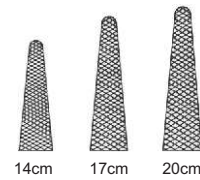

07-9301 - 07-9303
MATHIEU
07-9301 17cm
07-9302 20cm
07-9303 23cm



07-9304 - 07-9307
MATHIEU-KOCHER
07-9304 14cm
07-9305 17cm
07-9306 20cm
07-9307 24cm

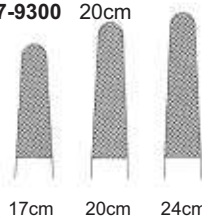

07-9308 - 07-9310
MATHIEU
07-9308 17cm
07-9309 20cm
07-9310 24cm



07-9311 - 07-9313
MATHIEU-VASCULAR
07-9311 17cm
07-9312 20cm
07-9313 24cm

Needle holders with Tungsten Carbide Inserts

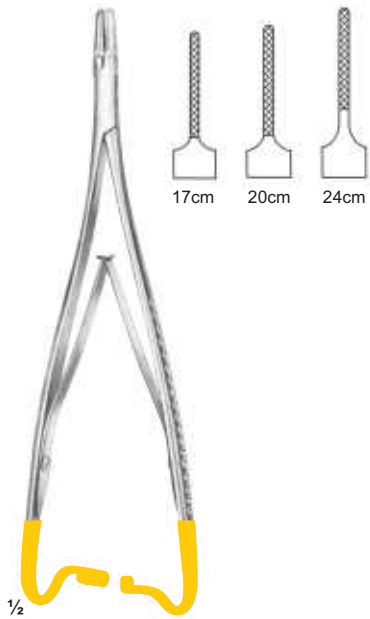

07-9314 - 07-9316
MATHIEU-RYDER
07-9314 17cm
07-9315 20cm
07-9316 24cm



07-9317
LICHTENBERG
20cm



07-9318 - 07-9319
LANGHALS
07-9318 20cm
07-9319 25cm



07-9320 - 07-9321
LICHTENBERG
07-9320 20cm
07-9321 25cm



07-9322 - 07-9323
LUETHY-BECK
07-9322 20cm
07-9323 25cm



07-9324 - 07-9325
LUETHY-BECK
07-9324 20cm
07-9325 25cm



07-9326 - 07-9328
LANGENBECK
07-9326 18cm
07-9327 20cm
07-9328 23cm



07-9329 - 07-9331
LANGENBECK
07-9329 18cm
07-9330 20cm
07-9331 23cm

Needle holders with Tungsten Carbide Inserts and Without TC



07-9332
STEVENS
15 cm



07-9333
KALT
14 cm



07-9334
KALT "HM"
14 cm



07-9335 - 07-9338
CASTROVIEJO
07-9335 14 cm STR
07-9336 17 cm STR
07-9337 14 cm CVD
07-9338 17 cm CVD



07-9339 - 07-9340
CASTROVIEJO
07-9339 14 cm
07-9340 17 cm



07-9341
CASTROVIEJO "HM"
13 cm

Needle holders with Tungsten Carbide Inserts and Without TC



07-9342- 07-9345
CASTROVIEJO "HM"
07-9342 14 cm smooth
07-9343 17 cm smooth
07-9344 14 cm serrated
07-9345 17 cm serrated



07-9346 - 07-9347
CASTROVIEJO-MICRO
14, 5 cm
07-9346 14.5 cm STR
07-9347 14.5 cm CVD



with catch

07-9348 - 07-9349
CASTROVIEJO-MICRO
14, 5 cm
07-9348 14.5 cm STR
07-9349 14.5 cm CVD

Ultra Fine



with catch

07-9350 - 07-9351
CASTROVIEJO
(KOSHIMA)
14, 5 cm
07-9350 14.5 cm STR
07-9351 14.5 cm CVD



07-9352 - 07-9353
CASTROVIEJO
(KOSHIMA)
14, 5 cm
07-9352 14.5 cm STR
07-9353 14.5 cm CVD